



Status of **Power System** Transformation 2017

System integration and local grids

INTERNATIONAL ENERGY AGENCY

The International Energy Agency (IEA), an autonomous agency, was established in November 1974. Its primary mandate was – and is – two-fold: to promote energy security amongst its member countries through collective response to physical disruptions in oil supply, and provide authoritative research and analysis on ways to ensure reliable, affordable and clean energy for its 29 member countries and beyond. The IEA carries out a comprehensive programme of energy co-operation among its member countries, each of which is obliged to hold oil stocks equivalent to 90 days of its net imports. The Agency's aims include the following objectives:

- Secure member countries' access to reliable and ample supplies of all forms of energy; in particular, through maintaining effective emergency response capabilities in case of oil supply disruptions.
- Promote sustainable energy policies that spur economic growth and environmental protection in a global context – particularly in terms of reducing greenhouse-gas emissions that contribute to climate change.
- Improve transparency of international markets through collection and analysis of energy data.
 - Support global collaboration on energy technology to secure future energy supplies and mitigate their environmental impact, including through improved energy efficiency and development and deployment of low-carbon technologies.
 - Find solutions to global energy challenges through engagement and dialogue with non-member countries, industry, international organisations and other stakeholders.

IEA member countries:



Australia
Austria
Belgium
Canada
Czech Republic
Denmark
Estonia
Finland
France
Germany
Greece
Hungary
Ireland
Italy
Japan
Korea
Luxembourg
Netherlands
New Zealand
Norway
Poland
Portugal
Slovak Republic
Spain
Sweden
Switzerland
Turkey
United Kingdom
United States

International Energy Agency
Secure
Sustainable
Together

© OECD/IEA, 2017

International Energy Agency
Website: www.iea.org

Please note that this publication is subject to specific restrictions that limit its use and distribution. The terms and conditions are available online at www.iea.org/t&c/

The European Commission also participates in the work of the IEA.

Table of contents

Acknowledgements	6
Executive summary	7
Chapter 1. Introduction	11
Objectives and scope	11
Structure of the report	12
Power system transformation assessment framework and case studies	13
References	14
Chapter 2. Transformation pathways and recent developments in the power sector	15
Current structures and pathways for power sector transformation.....	15
Current structures and pathways	15
Recent trends and developments in the power sector	20
Building on lessons learned	20
Evolving roles, actors and interests	21
Emerging investment frameworks.....	22
Responses to changing market conditions and technology drivers	24
Evolving public policy and regulatory strategies	25
Adoption of new end-use technologies	26
EVs.....	26
Smart and efficient buildings	27
Heat pumps.....	28
References	29
Chapter 3. Transforming power system planning and operation to support VRE integration	34
Challenges depend on different phases of VRE deployment	35
Technological options and operational practices to address operational challenges of VRE. 37	
Technical measures.....	38
Economic measures	43
The need for operational requirements relevant to VRE plants	48
The role of grid codes and VRE plants	48
Technical requirements are prioritised according to the level of VRE deployment.....	49
Integrated planning with higher deployment of VRE.....	50
Integrated planning incorporating demand resources.....	51
Integrated generation and network planning	52
Integrated planning between the power sector and other sectors	52
Inter-regional planning	53
Planning and operation of low- and medium-voltage grids in light of increased DER.....	54
New planning requirements	54
Improved screening/study techniques	55
Advanced data-driven local system management	55

References	56
Chapter 4. Policy, regulatory and market frameworks to support VRE integration	59
Policy, market and regulatory frameworks for efficient operation of the power system	59
Least-cost dispatch - the role of short-term markets (minutes to hours).....	59
Moving operational decisions and trade closer to real time.....	61
Improving pricing during scarcity/capacity shortage	63
Designing capacity mechanisms	64
Reforming mechanisms for the procurement of system services.....	65
Exchanging electricity over larger geographical areas	66
Ensuring sufficient investment in clean power generation.....	69
Pricing of negative externalities	71
Unlocking sufficient levels of flexibility	72
Flexible generation	72
Demand-side integration	72
Storage.....	73
Grid investment	74
References	75
Chapter 5. Topical focus: Evolution of local grids	79
A paradigm shift – local grids in future energy systems.....	79
Current drivers for change.....	80
Smartening of local grids by utilities.....	80
Long-term vision for local grids	82
How to foster the opportunities of digitalization.....	84
Secure and effective system operations under a high degree of decentralisation.....	85
Addressing DER – a focus on solar PV.....	85
Smart grid options	87
Advanced modelling capabilities	87
Ensuring economic efficiency and social fairness through compensation mechanism and retail rate design.....	88
The need for a new retail rate design.....	88
Degrees of granularity for retail tariffs.....	89
Compensating DER.....	90
Implications for policy design	91
Revisiting roles and responsibilities	92
Elements of structural reform	93
References	94
Chapter 6. Power system transformation assessment framework and case studies	96
Framework for assessing power system transformation	96
Markets and operations.....	96
Planning and infrastructure development.....	96
Uptake of innovative technology.....	97

Efficiency and sector coupling	97
Indonesia	99
General overview of Indonesia’s power sector	99
Market and operations	100
Planning and infrastructure development.....	102
Uptake of innovative technologies	103
Efficiency and sector coupling	104
Summary and main observations	105
South Africa	107
General overview of South Africa’s power sector	107
Market and operations	108
Planning and infrastructure development.....	111
Uptake of innovative technologies	112
Efficiency and sector coupling	113
Summary and main observations	114
Mexico	115
General overview of the Mexican power sector	115
Markets and operations.....	117
Planning and infrastructure development.....	120
Uptake of innovative technologies	122
Efficiency and sector coupling	123
Summary and main observations	124
Australia.....	125
General overview of Australia’s power sector.....	125
Market and operations	128
Planning and infrastructure development.....	132
Uptake of innovative technologies	133
Efficiency and sector coupling	135
Summary and main observations	136
References	137
Annex A. Details of technical measures to address power system challenges	141
Introduction.....	141
Technical measures during the later phases of VRE deployment	141
References	149
Abbreviations and acronyms.....	151
Units of measure	153
List of figures	
Figure 2.1 • Typical models for electricity sector ownership and participation.....	16
Figure 2.2 • Map of the status of liberalisation in the electricity sector	16
Figure 2.3 • Illustrative scenarios for power system transformation.....	18

Figure 2.4	• Present status and adjacent pathways to power system transformation.....	19
Figure 2.5	• Positive feedback between declining grid-based carbon intensity and electrified end uses	27
Figure 3.1	• Different aspects of system integration of VRE	35
Figure 3.2	• Annual VRE share of generation in selected countries and corresponding VRE phase, 2015	37
Figure 3.3	• Generation pattern of hard-coal power plants, 2016, Germany	41
Figure 3.4	• Regulating reserve requirement in ERCOT before and after reducing dispatch intervals	46
Figure 3.5	• Benefits of combined balancing area operations	47
Figure 3.6	• Interconnector flows and wind generation in Denmark.....	48
Figure 4.1	• Overview of the different building blocks of electricity markets.....	61
Figure 4.2	• Monthly trading volumes on the German intraday market, 2012-16	62
Figure 4.3	• Examples of operating reserve demand curves (ORDCs) in the ERCOT region, summer 2017	63
Figure 4.4	• Utilities participating in the EIM	67
Figure 4.5	• CREZs in Texas	74
Figure 5.1	• Global installed capacity of residential-scale solar PV, 2010-15.....	80
Figure 5.2	• Overview of selected options for electrification of heating and transport	82
Figure 5.3	• Impact of decentralisation and digitalization on local power grids.....	82
Figure 5.5	• Technical services available from solar PV systems.....	86
Figure 5.6	• Options for retail pricing at different levels of granularity	90
Figure 5.7	• Value components of local generation	91
Figure 5.8	• Changes at the interface between transmission and local grids	92
Figure 6.1	• Electricity generation by fuel type, 2004-14, Indonesia	99
Figure 6.2	• Indonesian major power plants and networks	100
Figure 6.3	• Average tariffs and total consumption of electricity per sector, Indonesia, 2015 ...	102
Figure 6.4	• Electricity generation by fuel type and VRE share, 2004-14, South Africa	107
Figure 6.5	• South Africa's transmission grid.....	108
Figure 6.6	• Megaflex tariff hours structure	110
Figure 6.7	• Electricity generation by fuel type and VRE share, 2005-15, Mexico	115
Figure 6.8	• National transmission grid of Mexico, 2014	116
Figure 6.9	• Capacity mix in the wholesale market, Mexico, 2016.....	118
Figure 6.10	• Electricity generation by fuel type and VRE share, 2005-15, Australia.....	125
Figure 6.11	• Transmission network in the NEM.....	126
Figure 6.12	• Wind forecasting system as part of the dispatch processes in the NEM.....	129
Figure A.1	• Examples of utility TOD factors in California	143
Figure A.2	• Generation output profiles of classical versus advanced wind turbines.....	144
Figure A.3	• Projections of SNSP in Ireland/North Ireland	146

List of tables

Table 1.1	• Dimensions of the assessment framework applied in case studies.....	13
Table 3.1	• Operational issues relevant to different phases of VRE deployment	36
Table 3.2	• Technological options and operational practices for different phases of VRE deployment.....	38
Table 3.3	• Incremental technical requirements for different phases of VRE deployment	49
Table 3.4	• Additional planning activities to integrate DER.....	54
Table 4.1	• Estimated benefits of the Western EIM, quarter 4, 2016.....	68

Table 5.1 • Overview of different smart grid technology options.....	87
Table 5.2 • Changing governance framework for local grids.....	93
Table 6.1 • Dimensions and criteria for applying the assessment framework.....	98
Table 6.2 • Key attributes and options for Indonesia.....	105
Table 6.3 • Key attributes and options for South Africa.....	114
Table 6.4 • Key issues and options for Mexico	124
Table 6.5 • Key attributes and options for Australia	136

List of boxes

Box 3.1 • The Control Centre of Renewable Energies in Spain.....	39
Box 3.2 • Coal plant flexibility in Germany	40
Box 3.3 • Use of forecast error for reserve determination, Spain.....	45
Box 3.4 • ERCOT real-time dispatch.....	46
Box 3.5 • Nordic market interconnection management	48
Box 3.6 • Ireland’s grid code	50
Box 3.7 • PacificCorp’s Integrated Resource Plan	51
Box 3.8 • Co-ordinated transmission network planning in Europe	54
Box 3.9 • Beyond 15% penetration: New technical DER interconnection screens for California ..	55
Box 5.1 • Data privacy considerations.....	85
Box 5.2 • Application of time-dependent pricing in France	88
Box 6.1 • Clean Energy Certificates	118
Box 6.2 • Implications for the changing role of coal plants in Australia.....	134
Box A.1 • DLR in the Snowy Region, Australia	142
Box A.2 • Denmark’s feed-in premium scheme to incentivise more advance wind turbine technologies.....	145
Box A.3 • Ireland’s work programme for establishing a maximum SNSP limit	145
Box A.4 • Requirements for wind turbines to provide IBFFR in Quebec.....	146
Box A.5 • Smart inverter rollout in Puerto Rico.....	147
Box A.6 • Chile’s grid level storage	148

Acknowledgements

The *Status of Power System Transformation 2017 Report* was prepared by the System Integration of Renewables (SIR) Unit of the International Energy Agency (IEA), in co-operation with the US National Renewable Energy Laboratory (NREL). This report was supported by the 21st Century Power Partnership (21CPP), an initiative under the Clean Energy Ministerial (CEM).

Page | 6

The main authors of the report from the IEA were Peerapat Vithayasrichareon (who also led and co-ordinated the analysis), Emanuele Bianco and Timon Dubbeling, while Owen Zinaman, Ilya Chernyakhovskiy, Jefferey Logan and Barry Mather participated from NREL. Manuel Baritaud, Matthew Wittenstein and Jesse Scott of the IEA Gas, Coal and Power Market Division also contributed to analysis (including review) of this report.

The report was developed under the supervision and guidance of Simon Mueller, Head of the SIR Unit. Douglas Arent, Executive Director of the Joint Institute for Strategic Energy Analysis at NREL and Daniel Noll from the United States Department of Energy helped coordinate and advised on production of the report.

Keisuke Sadamori, Director of Energy Markets and Security and Paolo Frankl, Head of the Renewable Energy Division at the IEA, provided comments and guidance. Laszlo Varro, IEA Chief Economist, and Rebecca Gaghen, IEA Head of the Communication and Information Office, reviewed the report and provided valuable advice. Kamel Ben Naceur, Director of Sustainability, Technology and Outlooks, and other IEA colleagues including Sylvia Beyer, Alfredo del Canto, Aang Darmawan, Marine Gorner, Cédric Philibert and Michael Waldron provided valuable comments and feedback.

The authors are grateful for the comments received from Julian Barquin (Endesa), Nate Blair (NREL), Rebecca Collyer (European Climate Foundation), Matthias Deutsch, Christian Redl (Agora Energiewende), Alice Didelot (Total New Energies), Daniel Fraile (WindEurope), Andreas Hauer (ZAE Bayern), Lion Hirth (Neon Neue Energieökonomik GmbH), Hannele Holttinen (VTT), Jorge Hidalgo Lopez (Red Eléctrica de España), Jochen Kreusel (ABB), Joan McNaughton (Climate Group), Jenny Riesz (AEMO), Charlie Smith (UVIG), Yusak Tanoto (Petra University), Frauke Thies (Smart Energy Demand Coalition) and Stefan Ulreich (E.ON SE).

Justin French-Brooks was the primary editor of this report. The authors would also like to thank the IEA Communication and Information Office, in particular Muriel Custodio, Astrid Dumond, Bertrand Sadin and Therese Walsh for their assistance in production.

Comments and questions on this report are welcome and should be addressed to SIR@iea.org.

Executive summary

In countries around the world, power sectors are undergoing significant change, with the desire to achieve sustainable, affordable and reliable electricity. Progress in both supply- and demand-side technologies, as well as increased digitalization and automation of end uses, is influencing how the power system is planned and operated. Responding to this change requires innovative approaches across the entire power system, spanning both institutional reforms and technical adaptations.

“Power system transformation”, the processes that facilitate and manage requisite changes in the power sector, is an active process of creating policy, market and regulatory environments, as well as establishing operational and planning practices, that accelerate investment, innovation and the use of smart, efficient, resilient and environmentally sound technology options. This report examines recent trends from the perspective of power system transformation, with a particular focus on the integration of variable renewable energy and the evolution of local grids.

Power system transformation takes place through interactions of technology, the physical electricity infrastructure, and market, policy and regulatory frameworks. Reflecting this link, this report provides both an update on a number of recent technical trends in power system operation and planning, and a discussion of how institutional frameworks can respond to technical developments. Chapter 1 introduces the concept of power system transformation. Chapter 2 provides an overview of and recent selected trends in power system transformation around the world. Chapter 3 has a strong technical emphasis, whereas Chapter 4 is more oriented towards policy, market and regulatory aspects. Chapter 5 discusses key concepts in local grids, while Chapter 6 provides a comprehensive method of assessment for tracking power system transformation, using selected case studies. Across the document, analytical considerations are supplemented by specific country examples, highlighting concrete actions taken in recent years.

Power system transformation is highly context specific, but common themes are emerging. Power systems differ both in their technical properties (e.g. generation mix, demand characteristics, network topology) and their regulatory paradigm (e.g. vertical integration, fixed tariffs or competitive markets). This means that solutions from one jurisdiction cannot simply be replicated in another. At the same time, a number of transferrable principles are emerging across the globe, as discussed below.

Structures and pathways for power system transformation

Current power sector structures exhibit a large degree of diversity. Generally, power systems have common roots in the traditional model of vertically integrated monopolies. However, this model is no longer present in pure form almost anywhere in the world; most markets allow for the participation of independent power producers (IPPs), at a minimum. In many markets, different roles in the power sector have been unbundled, for example by putting the operation of the transmission system into the hands of an independent entity, and in some cases competitive wholesale and retail markets have been put in place. Based on these diverse starting points, this report presents different pathways for power system transformation depending on initial conditions. These pathways are characterised by the extent and speed of the transformation envisaged, classified into “Adaptation”, “Evolution”, “Reconstruction” and “Revolution” scenarios.

A range of emergent trends are shaping power sector transformation around the world. This report provides a review of a number of these trends. The increased knowledge of and experience with integration of variable renewable energy (VRE) is a principal focus of this edition

of the *Status of Power System Transformation Report*. Through the use of competitive auction schemes, among other important factors including technology cost reductions, the price of utility-scale wind and solar photovoltaic (PV) power plants has come down considerably in recent years. In addition, system operators and other power system actors are increasingly skilled at mobilising power system flexibility in a reliable and cost-effective manner to support the integration of VRE. A further trend analysed in greater detail is the transformation of local electricity grids, driven by the growing deployment of distributed energy resources. Other trends reflected in the report are a refined evaluation of energy access, increased participation of the private sector in markets with growing power demand, and the implications of sluggish demand growth in other regions.

Transforming power system operation and planning to support VRE integration

Integration of VRE requires specific measures to maintain the cost-effectiveness and reliability of the power system, which evolve as VRE deployment increases. This report identifies four phases of VRE integration and associated operational issues, differentiated by the increasing impact of growing shares of VRE generation on the power system. Different measures have been employed to address integration challenges. These can be considered according to the specific requirements and objectives of the power system. This report reviews a number of technical and economic measures, differentiated by the phase of VRE deployment. These include: monitoring and control of VRE plants; measures to boost transmission line capacity; power plant flexibility; special protection schemes; advanced operational practices for pumped hydropower storage plants; strategies to extract system services from VRE plants; advanced VRE power plant design; grid-level storage options; sophisticated approaches to formulating operating reserve requirements; integration of VRE production forecasts; improved power plant and VRE dispatch; and increased balancing area co-ordination;

To ensure different measures work in concert, robust and integrative planning is key. In many jurisdictions, increasingly integrated and co-ordinated planning frameworks have played a key role in the cost-effective and reliable accommodation of higher shares of VRE in the power system. This report provides examples of emerging power sector planning practices, including: integrated planning across a diversity of supply and demand resources; integrated generation and network planning; integrated planning between the power sector and other sectors, particularly transport, and heating and cooling; and inter-regional planning across different balancing areas.

Policy, regulatory and market frameworks to support utility-scale VRE integration

Policy, market and regulatory frameworks have a critical role in guiding operational and investment decisions. In the context of power system transformation, the large-scale uptake of VRE challenges traditional policy, market and regulatory frameworks. This is true for nearly all market structures, whether they lean towards more competitive and liberalised markets, or towards a vertically integrated model. However, the required adaptations will be different in each circumstance, reflecting different starting points. Globally, a degree of convergence in the required adaptation between the different models can be observed.

In jurisdictions where vertically integrated models have prevailed so far, a push is being seen towards introducing mechanisms to improve the efficiency of power system operation. For example, the ongoing power market reform in China aims for the introduction of a market mechanism to co-ordinate the dispatch of power plants in a more cost-efficient manner from a system perspective. In turn, countries that have pioneered power market liberalisation have seen a tendency to implement supplementary mechanisms to ensure security of electricity supply. For

example, the United Kingdom integrated a centralised forward-capacity market and a long-term contracts-for-difference mechanism for low-carbon generation.

Five broad market, policy and regulatory framework objectives greatly enable the integration of larger shares of VRE in the context of power system transformation:

- ensuring electricity security of supply, including measures to ensure that generator revenues reflect their full contribution to system security
- efficient operation of the power system at growing shares of variable and decentralised generation, including measures to unlock flexibility from all existing resources, improve dispatch practices by moving operational decisions closer to real time, and encouraging efficient energy price discovery through competitive frameworks
- ensuring sufficient investment certainty to attract low-cost financing for capital-intensive investment in clean power generation, including well-structured PPAs for IPP projects
- pricing of negative externalities, including measures to constrain local air pollution or carbon emissions when locally appropriate
- ensuring the integration and development of new sources of flexibility, including from thermal generators, grids, demand response resources and storage.

Basic economic theory suggests that pricing externalities and introducing a well-designed wholesale energy market (energy-only market) should suffice to achieve all five objectives. However, practical experience across a broad range of countries has highlighted that such an approach is either very difficult to implement, or does not address all relevant challenges faced by markets, particularly those that are far from their economic equilibrium during a clean energy transition. This report describes a multitude of instruments and approaches applied in a diverse set of jurisdictions to achieve the aforementioned objectives.

Evolution of local grids

Low- and medium-voltage grids are changing, away from a paradigm of passively distributed power to customers and towards smarter, actively managed systems with bidirectional flows of power and data. A successful transition will require due consideration of three key dimensions: technical, economic and institutional:

- Technologically, ensuring secure and effective system operation under a high degree of decentralisation leads to new priorities for utilities and regulators. Use of advanced information and communication technology (digitalization) allows for improved visibility and control of systems and has the potential to unlock substantial demand response.
- Economically, the rise of distributed solar PV and the improving economics of batteries call for a reform of retail electricity pricing and taxation. This includes both remunerating distributed resources according to their value and making users of the grid contribute a fair proportion to the cost of shared infrastructure.
- Institutionally, roles and responsibilities are likely to change. One priority is better co-ordination between operators in charge of local grids and those in charge of transmission system operation. In addition, totally new actors, such as aggregators, should be incorporated into the institutional landscape.

Assessment frameworks and country case studies

An updated framework for assessing different aspects of power system transformation is introduced in this report. The assessment framework is applied to assess the status of power system transformation in Indonesia, South Africa, Mexico and Australia. They are presented in this order to reflect the relative level of evolution of the power sector structure in each country.

These countries offer a diversity of experience for analysis due to their distinct social, economic and geographic contexts. Each of these countries is unique in their electricity sector institutional structure, network topology, levels of VRE deployment, uptake of new technology and regulatory and market paradigms.

Power system transformation is a complex process that requires a considerable amount of policy attention. If managed well, it holds the promise of helping to ensure affordable, reliable and sustainable energy. This report aims to support countries in their own transition by sharing international experience.

Chapter 1. Introduction

Many power systems around the globe are undergoing a period of rapid change. The perennial desire for affordable and reliable power systems is now influenced by a variety of developments, including:

- A desire to reduce environmental impacts (including local air pollution, carbon emissions and water use).
- Rapid cost reductions in new supply- and demand-side technologies (e.g. low-cost wind and solar power, electric vehicles (EVs)).
- Increasing digitalization and automation of end uses.
- An increasing focus on promoting resiliency within power systems.
- Expansion of energy access using innovative technology and market solutions.

Responding to these changes requires innovative approaches across the entire power system, spanning both institutional reforms and technical adaptations. In addition to new business models driven by the private sector, this may include a need for governments to change policy, market and regulatory frameworks. It may also include augmenting the ways in which the power system is planned and operated.

Power system transformation, in the context of this report, can be defined as the active process of creating the policy, market, and regulatory environments, as well as establishing operational and planning practices, that accelerate investment, innovation and the use of smart, efficient, resilient and environmentally sound technology options.

Rapidly improving economics of large-scale renewable energy technologies, notably wind and solar power, successful improvements in energy efficiency and economic restructuring, as well as increasing digitalisation and automation of system operation and planning, have been among the main drivers of power system transformation, alongside the uptake of distributed energy resources (DER). Successful integration of these novel technologies, particularly at large shares, can imply a transformation of the power system. Looking further into the future, these developments may result in a paradigm shift, away from fully centralised generation, transmission and distribution, towards a more heterogeneous “system of systems” which includes centralised, local, and island grids. In addition, increasing amounts of energy system integration will be seen, such as coupling with other sectors (particularly transport, and heating and cooling).

Objectives and scope

The aim of this report is to provide an overview of current trends in the field of power system transformation, with a particular focus on the integration of renewables and the evolution of local grids. A further main objective of this report is to introduce a framework for assessing the progress of power system transformation in a country or jurisdiction. This assessment framework is applied to selected countries participating in the Clean Energy Ministerial (CEM); these case study countries are Indonesia, South Africa, Mexico and Australia, presented in this order to reflect the relative stage of development of their power structures. The case studies discuss the status of power system transformation in the context of each specific country.

Rather than aiming for a fully comprehensive discussion, this report provides a broad set of recent concrete examples, combined with analytical context, to inform policy makers and power system practitioners of ongoing developments across the globe. The focus is on recent trends

and examples that are pertinent and have implications for the integration of renewables and local grid development.

The report builds upon the May 2015 21st Century Power Partnership (21CPP) report entitled “Status Report on Power System Transformation”, which was presented at the 6th Clean Energy Ministerial in Mérida, Mexico (Miller et al., 2015).

Not every aspect of power system transformation is included in this report. In some parts of the world, notably North America, for example, significant changes have occurred in power systems due not only to a rise in variable renewable energy (VRE), but also to the abundant and low-priced supply of natural gas. Similarly, the role that nuclear energy, carbon capture and storage, or dispatchable renewable options, such as reservoir hydropower or concentrating solar power, can play in power system transformation is not a main focus of this report. Finally, the report does not provide an exhaustive discussion of traditional power system restructuring that many countries continue to conduct, although broader aspects of power system transformation pathways are discussed in Chapter 2.

Structure of the report

The report has four main components. Chapter 2 provides a general conceptual overview for policy makers of the possible pathways of power system transformation, depending on the starting point in different jurisdictions. This section also provides an outline of recent selected trends in power system transformation around the world, including trends in the uptake of innovative end-use technologies. The report focuses in particular on trends that are related to, or have implications for, integration of renewable energy.

Chapters 3 and 4 focus on strategies for integrating VRE, specifically wind power and solar photovoltaics (PV), into power systems. Against a background of rapidly improving economics and advancing technological capabilities, many countries have begun facilitating VRE deployment without traditional forms of public policy support. With VRE resources becoming the least-cost form of new-build generation in many countries, there is an increasing focus on how public policy, regulation, market design, system operations and planning practices must evolve to effectively deploy and integrate these resources. Chapters 3 and 4 offer examples of good practices and recent experiences to this end. Chapter 3, intended for a technical audience, provides an in-depth review of the technological, operational and power system planning issues relevant for different phases of VRE deployment. Chapter 4, intended for a policy maker audience, reviews emerging policy, regulatory and market frameworks to support cost-effective utility-scale VRE integration at different phases of VRE deployment.

Chapter 5 takes a longer-term perspective, investigating changes in what we define as “local grids”. Traditionally termed distribution grids, these medium- and low-voltage networks are undergoing a transition from passive grids that simply distribute electricity towards intelligent, actively managed and participatory electricity networks. This section is intended as a more conceptual piece for interested stakeholder audiences, identifying the drivers of change in local grids and reviewing key policy and institutional mechanisms for ensuring economic efficiency and social fairness as local grids evolve.

Chapter 6 sets out a comprehensive assessment framework for tracking power system transformation, and applies this framework to case study examples from four countries: Indonesia, South Africa, Mexico and Australia.

Power system transformation assessment framework and case studies

In addition to examining recent trends and developments in the power sector, this report introduces an assessment framework for analysing and tracking the status of power system transformation. This assessment framework examines four aspects that are relevant to power system transformation: markets and operations; planning and infrastructure; uptake of innovative technology; and efficiency and sector coupling.

Table 1.1 presents a simplified summary version of the assessment framework that is presented in detail and applied in Chapter 6.

Table 1.1 • Dimensions of the assessment framework applied in case studies.

Aspect	Description and relevance
Markets and operations	The structure of electricity markets and how they are operated, both at the wholesale and retail levels, is a key driver of power system transformation. Emerging market frameworks and improved system operations can help cost-effectively manage electricity delivery infrastructure with greater shares of VRE resources; changes to retail rate structures and regulatory paradigms can help to activate and engage demand-side resources to contribute to the system.
Planning and infrastructure	Power system planning determines the future architecture of the power generation, transmission and distribution systems. Emerging, integrated approaches to power system planning and grid expansion can facilitate an efficient transformation of the power system, while maintaining affordability and reliability; it can also prepare electricity grids for the effective integration of greater technological innovation.
Uptake of innovative technology	An array of emerging innovative technologies, including smart technologies, flexible resources, and system-friendly VRE, can enable a more flexible, reliable and affordable power system.
Efficiency and sector coupling	Greater energy efficiency in the power sector can help reduce costs both at the system and customer level. Electrification across the transport, and heating and cooling sectors, in combination with the broader trend of cross-sectoral integration of the demand side into electricity markets, can compound the benefits of clean energy deployment and hasten the transition to a low-carbon power system.

Four case studies have been selected: Indonesia, South Africa, Mexico and Australia. These countries capture the diversity of contexts and drivers for power system transformation around the world. These case studies are examined in detail in Chapter 6 of the report.

- **Indonesia** represents an example of a rapidly growing power system, where affordability and energy access are primary drivers. While these drivers put pressure on expanding the system quickly and with conventional solutions, they also provide an opportunity to move towards a 21st-century power system in the process. Indonesia has a vertically integrated structure where the state-owned Perusahaan Listrik Negara (PLN) is in charge of the power sector, while allowing independent power producer (IPP) participation. The market for innovative technologies, including non-hydropower renewables is at a nascent stage.
- **South Africa** experienced rapid system growth in past decades, but in recent years has faced stagnant electricity demand growth, a growing situation of overcapacity and rising electricity prices for consumers. The commissioning of large thermal plants has reversed a structural

generation shortage to a situation of overcapacity, which provides a buffer in advance of significant expected plant retirements in the coming years. A highly successful competitive procurement framework for renewable energy has kick-started the market for low-cost, clean power, but further VRE deployment has recently been paused due to a variety of factors.

- **Mexico** is anticipating growing demand for electricity against a backdrop of an existing generation fleet that includes combined-cycle gas turbines (CCGTs), national VRE goals and rapidly dropping VRE prices. As part of energy sector-wide reform, with a view to attracting private-sector investment and improving system cost-effectiveness, a systematic restructuring of the electricity sector is under way. Mexico is in the process of moving from a vertically integrated paradigm to a competitive wholesale market, while simultaneously pursuing aggressive clean energy targets. The reforms have been relatively rapid and comprehensive. A sophisticated auction system has been able to attract low-cost, large-scale investment.
- **Australia** has been a pioneer of electricity market liberalisation; the private sector has been responsible for the bulk of power system investment in the past. Driven by support policies (green certificate system and incentives for distributed solar), Australia has reached the highest penetration of distributed solar PV per capita in the world. It is also experiencing a rapid uptake of large-scale wind and, most recently, solar power plants. Electricity demand has stagnated over recent years and wholesale electricity prices are highly volatile. The question of how to remunerate new investment under these circumstances is receiving considerable attention. Following a state-wide blackout during a severe storm in South Australia on 28 September 2016, advanced strategies for system integration are being implemented with expediency.

References

Miller, M. et al. (2015), *Status Report on Power System Transformation, 21st Century Power Partnership (CPP)*.

Chapter 2. Transformation pathways and recent developments in the power sector

HIGHLIGHTS

- Power system transformation is under way in many jurisdictions around the world, although the speed and scope of change varies significantly.
- The ultimate direction of transformation pathways is heavily influenced by the prevailing market structure and roles and responsibilities of actors.
- A growing body of knowledge and experience exists to help inform jurisdictions on potential transformation strategies, including evolving knowledge of ways to integrate variable renewable energy (VRE) and distributed energy resources (DER) efficiently, equitably and at least cost, although much remains to be learned at relatively higher levels of penetration.
- Recent trends and developments in the power sector span technological, institutional and business model innovations.

This section begins with a brief discussion of current institutional structures in power sectors around the globe and defines the diversity of starting points for transformation. It then describes several potential pathways that power sector planners and policy makers may choose to pursue. It also provides a review of recent trends and developments in global power systems with specific examples, and then discusses the importance of various end-use technologies that can further enable power system transformation.

Current structures and pathways for power sector transformation

The first round of significant modern-day global power system transformation began around 1990 when a select group of jurisdictions started to restructure their traditional, vertically integrated utilities (IEA, 1999; Bacon, 1995; Joskow and Schmalensee, 1983). There is a rich history of the improvements and setbacks that this round of restructuring provided (Gratwick and Eberhard, 2008; Sioshansi and Pfaffenberger, 2006; Williams and Ghanadan, 2005). In short, these reforms aimed at putting an independent entity in charge of operating the power system and introducing competition among large-scale generators. Depending on the depth and ambition of reforms, some retail markets were also opened for competition.

Over the last decade, however, new drivers of change have emerged to further stimulate power system transformation. Some of these technology drivers include utility-scale wind and solar, distributed generation, smart grids, energy storage, and energy efficiency – all available at increasingly competitive prices. Other drivers include new incentives, business models and institutional approaches that further encourage or leverage changes to power systems. In many regions of the world, these changes are beginning to challenge traditional grid planning and operating practices, as well as utility and non-utility business models (Kind, 2013). For countries focused on expanding access to electricity, the new opportunities and challenges under this evolving landscape can prove both exciting and dizzying.

Current structures and pathways

Current power sector structures show a large degree of diversity when measured within policy, market and regulatory frameworks. Generally speaking, they all have common roots in the

vertically integrated model and have evolved uniquely from there. Current arrangements can be classified at a high-level into five models: vertical integration; single-buyer; unbundling; wholesale market and retail competition (Figure 2.1). These models differ according to the level of private participation in the electricity sector. Note that movement from left to right (from vertical integration to retail competition) is not necessarily indicative of progress; rather, it represents the degree to which roles and responsibilities are allocated to different entities.

Figure 2.1 • Typical models for electricity sector ownership and participation

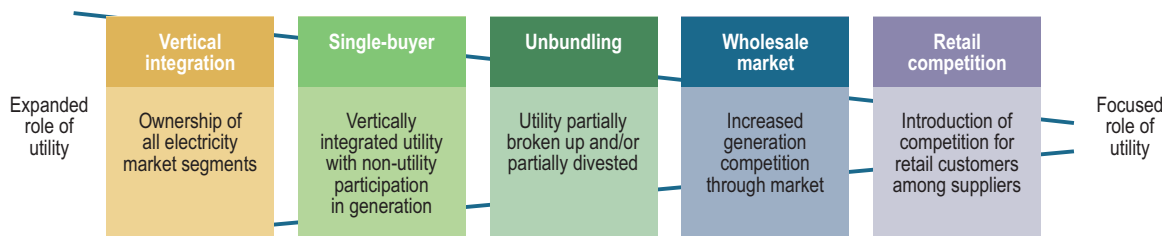

Source: Adapted from Castalia (2013), *International Experience with Single Buyer Models for Electricity*.

Key point • The role of the utility is reduced with increased private-sector participation.

Vertically integrated utilities include generation, transmission, distribution and retail sales under one organisational structure (Joskow, 2003). They can be private, state-owned or even part of ministries with no private-sector participation. Analysis by the International Energy Agency (IEA) indicates that this pure monopoly framework represented only 6% of the electricity consumed globally in 2012 (Figure 2.2) (IEA, 2016a).

Figure 2.2 • Map of the status of liberalisation in the electricity sector

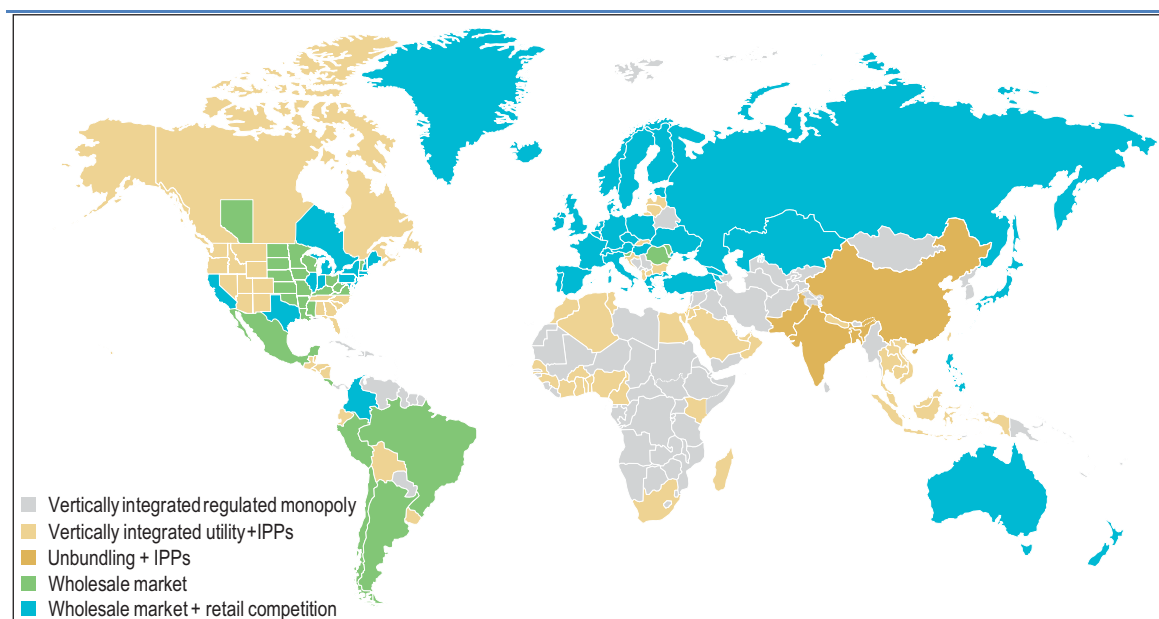

This map is without prejudice to the status of or sovereignty over any territory, to the delimitation of international frontiers and boundaries and to the name of any territory, city or area.

Source: IEA (2016a), *Re-powering Markets: Market Design and Regulation during the Transition to Low-Carbon Power Systems*.

Key point • Electricity sectors have been restructured in most jurisdictions, with differing degrees of competition being introduced.

The most basic level of competition is the introduction of independent power producers (IPPs), which allows private entities to build, own and operate power plants and sell their output to the utility. The main objective of the model is to overcome investment shortages and inefficiencies that vertically integrated utilities tend to exhibit. In this model, IPPs enter into long-term power

purchase agreements (PPAs) with utilities to supply generation at an agreed price, without the need for government investment. The PPAs typically place the planning and much of the market risk on the utility, while the IPP is responsible for risk during plant construction and overall operational efficiency of the generator. This stage is often referred to as the single-buyer model (Figure 2.1).

In the United States, the federal legislature opened the power system to IPPs with the Public Utility Regulatory Policy Act (PURPA), passed in 1978, and this arrangement can still be found in a number of US states. The single-buyer model is also predominant in most Asian countries, including Indonesia, Thailand, Malaysia and Viet Nam, and in many countries of the Middle East.

This model has been highly effective in attracting low-cost, large-scale renewable energy projects over the years. Arguably, the very low prices observed in recent IPP auctions have been important evidence of the increasing cost-competitiveness of new technologies, such as wind and solar photovoltaics (PV). For example, the lowest currently reported long-term contract prices for land-based wind are USD 30-35 per megawatt hour (MWh) (Morocco) and USD 25/MWh for solar PV (Dubai).

Unbundling represents a further step in market reform (middle box in Figure 2.1). In unbundled systems, vertically integrated utilities are divided into distinct companies, which separately own or operate generation, transmission grid, and distribution network assets with related services. The most common form of unbundling is the separation of transmission system operation (and in some cases asset ownership) from the rest of the system.

The next phase introduces a competitive market where buyers and sellers of wholesale electricity are able to transact in a centralised trading platform (fourth box in Figure 2.1). Competitive wholesale markets are a common structure in the United States, the European Union and South America (e.g. Chile, Colombia). Mexico recently moved to a wholesale market model, while simultaneously breaking up state-owned generation and distribution businesses into smaller (but still state-owned) entities (Shah et. al, 2016; IEA, 2016c).

The last step introduces a competitive retail market where end-users (industrial, commercial and/or residential customers) can choose which retail company provides the energy component of their service (last box in Figure 2.1). New Zealand and Texas are examples of fully restructured electricity markets that have both wholesale and retail competition.

These stages of power system evolution are not necessarily a natural evolution in one direction. Some jurisdictions, such as New Zealand, have considered moving to the left (from retail competition) rather than to the right in Figure 2.1. Many US states stalled their restructuring process in the early 2000s when the risks appeared to outweigh some of the benefits (Borenstein and Bushnell, 2015; EIA, 2010).

Most recently, certain organised wholesale markets in the United States have instituted “around market” mechanisms to ensure continued participation of firm generation, leading some to claim that certain states may soon abandon wholesale markets and return to “re-regulation” (Gifford and Larson, 2017).¹

Expanding energy access

In jurisdictions that are attempting to rapidly expand access to electricity, policy makers, regulators and other stakeholders face additional challenges and opportunities (Odarno et al.,

¹ Organised markets refer to markets where regional transmission organisations (RTOs) or independent system operators (ISOs) are regulated by the Federal Energy Regulatory Commission (FERC) as well as the Electric Reliability Council of Texas (ERCOT). “Around market” mechanisms are solutions that seek to preserve baseload capacity and maintain system reliability, which can include vertical reintegration, the prescriptive replacement capacity approach and the backdoor capacity payment.

2017). Advancing from solar home systems or autonomous systems for relatively low levels of consumption, decision makers must decide among multiple options for serving increased demand. Extending the high-voltage grid was traditionally considered the only robust and cost-effective pathway forward. Recent trends suggest that mini- and micro-grids that rely on distributed generation may ultimately be less time- and capital-intensive than traditional transmission grid investments in certain situations. For example, in Kenya, a private utility (Powerhive) has been operating a micro-grid with 80 kilowatts of solar PV that serves over 1 500 individuals. The system was carefully planned and co-ordinated with local needs, and serves as a model to extend the grid in other regions (Impact Amplifier, 2017).

Likewise, as new infrastructure is added, it can be designed to leverage emerging technologies that enable greater control of demand rather than just supply, and integrate new institutional approaches to plan and operate the electricity market with higher levels of variable generation. One challenge with mini- and micro-grids is knowing in advance if and when the high-voltage grid will be extended to the previously unserved location, as this uncertainty creates business model risk for developers of mini- and micro-grids (Odarno et al., 2017; Moner-Girona, 2008).

Transformation pathways for the power sector

From an institutional perspective, power system transformation can occur across a variety of pathways depending on initial conditions and the desired end state. Zinaman et al. (2015) illustrate four example scenarios that define end states based on the extent of required change and the speed at which it occurs (Figure 2.3).

Figure 2.3 • Illustrative scenarios for power system transformation

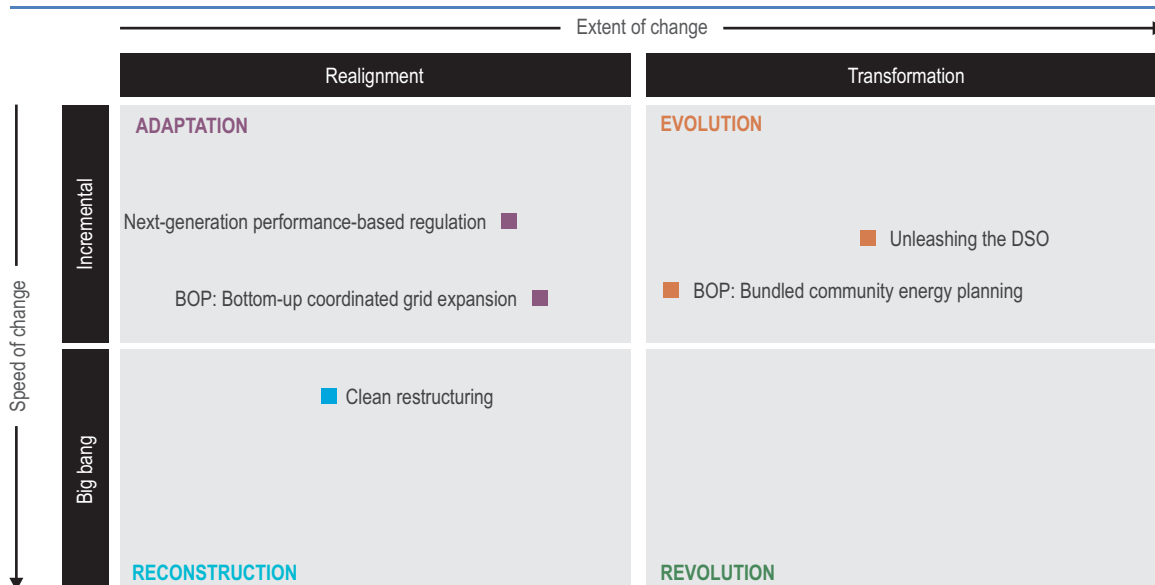

Source: Zinaman et al. (2015), *Power Systems of the Future*.

Key point • Transformations can be considered through the lens of the speed and extent of change.

In the “Adaptation” scenario, limited and incremental change reflects efforts underway in many regions around the globe, based on a near-status-quo future. “Next-generation performance-based regulation”² and “Bottom-up co-ordinated grid expansion” pathways are two examples of power system reform emblematic of an Adaptation transition. In the former, vertically integrated

² This pathway will be described in detail in a forthcoming 21st Century Power Partnership report entitled “The next-generation performance-based regulation pathway”, to be released in June 2017.

utilities still exist, but they are regulated to prioritise delivering societal value (specific targets and behavioural outcomes, such as increased reliability or energy efficiency, for example) instead of simple recovery of capital investment. In the latter pathway, access to energy is accelerated by taking advantage of new technology configurations and business models, as outlined by the International Finance Corporation (IFC, 2012a).

The “Evolution” scenario envisages more comprehensive change over a longer period of time (i.e. 10-20 years), leading to a system with balanced amounts of centralised and distributed generation, smart electric vehicle (EV) charging and demand response, for example. “Unleashing the DSO” (distribution system operator) is a pathway in this scenario that champions distributed energy resources and low-voltage market operations. Reforms underway in the state of New York under the Reforming the Energy Vision (REV) exemplify this pathway in restructured markets, while in jurisdictions aiming to boost energy access, the “Bottom of the Pyramid (BOP): Bundled Community Energy Planning” does the same (IFC, 2012a).

“Reconstruction” occurs more rapidly but without fundamental changes in technologies or market participants. The set of ongoing reforms in Mexico, classified here as the “Clean restructuring”³ pathway, exemplifies this scenario. Additional information about Mexico’s reforms is provided in the country case study.

The most far-reaching scenario, “Revolution”, implies both fundamental and rapid changes, perhaps leading to fully competitive markets with real-time electricity pricing at the retail level, or the emergence of a “black swan” technology, such as highly affordable and widely accessible energy storage that fundamentally alters the landscape of transformation. Rocky Mountain Institute’s “The Economics of Load Defection” (RMI, 2015) and IFC’s “Community-level Mini-Utilities” scenario (IFC, 2012a) evaluate these possibilities from a developed and developing country perspective, respectively.

Figure 2.4 illustrates each of the present states of power systems discussed in the previous sections, and the applicability of alternative pathways to greater power system transformation.

Figure 2.4 • Present status and adjacent pathways to power system transformation

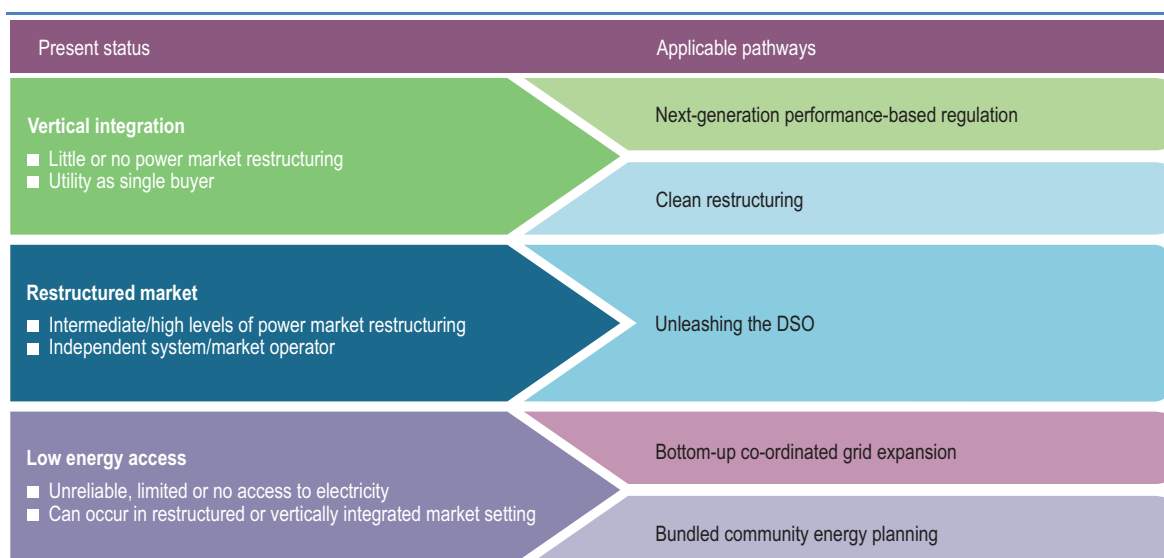

Source: Zinaman et al. (2015), *Power Systems of the Future*.

Key point • Power system legacies shape the landscape of options available for transformation.

³ This pathway is described in detail in the 21st Century Power Partnership report entitled “Clean restructuring: Design elements for low-carbon wholesale markets and beyond”, available at: www.nrel.gov/docs/fy16osti/66105.pdf.

Recent trends and developments in the power sector

A range of emergent trends is shaping power sector transformation around the world. Several key examples are provided below. This list is not intended to be exhaustive, nor is the organisational framework meant to be prescriptive. Rather, this list offers a sample of compelling stories from around the world on the direction of power sector innovation and transformation as observed today.

Page | 20

Reflecting their prominent role in driving power system transformation, the focus of these trends is on the integration and deployment of renewable energy technologies. Certain topics, including the evolution of electricity demand, the future of nuclear energy, market dynamics of coal and gas generation, and security of electricity supply, are beyond the scope of this report.

- **Building on lessons learned**
 - Increasing knowledge of and experience with VRE integration in planning and operations, and in the design of policy, regulation and markets
 - Refined evaluation and measurement of energy access
- **Evolving roles, actors and interests**
 - Increasing participation of demand-side resources through market, policy and regulatory reform
 - Greater private-sector participation in dynamic electricity markets
 - Innovative support for low-income customers through rooftop solar programmes
- **Emerging investment frameworks**
 - Increasingly system-friendly procurement of VRE resources
 - Evolving regulatory frameworks for encouraging investment in DER
 - Reduced investment potential in wholesale power markets with static demand growth
- **Responses to changing market conditions and technology drivers**
 - Increasing flexibility of thermal generation fleets
 - Increasing cross-border co-ordination and power sector integration
 - Relying on stand-alone, small-scale power systems for providing rural energy services
- **Evolving public policy and regulatory strategies**
 - More ambitious targets for renewable energy deployment
 - Increasing competitive procurement of VRE capacity
 - Value-based remuneration for DER customers
 - Greater investment and incentives for vehicle electrification

Building on lessons learned

Increasing knowledge of and experience with VRE integration

Effective integration of VRE requires holistic thinking across aspects of generation and transmission planning, infrastructure build-out, system operations techniques, and market and retail rate regulation. Recently there has been healthy international diffusion of ideas and techniques for grid integration, with movement in many jurisdictions from experimentation to more concrete adoption of successful practices. This is particularly the case in jurisdictions with relatively high shares of VRE generation, such as Denmark, Ireland and Spain. In other words, a

growing number of examples of success, failure and good practice are available from a diverse set of countries. These provide important lessons for others to consider.

Despite this evidence, discussion of VRE integration is often still marred by misconceptions, myths and, in certain cases, even misinformation. Commonly heard claims include that 1:1 back up or electricity storage is a prerequisite to integrate VRE, and that conventional generators are exposed to very high additional costs as VRE share grows. Such claims can distract decision makers from the real issues; if unchecked they can bring VRE deployment to a shuddering halt. Successful management of integration challenges, in particular in emerging and developing countries, is likely to require substantial effort and effective international collaboration. Emerging technological options and operational practices adopted by system operators to integrate VRE are discussed in detail in the next chapter. A practical guide to navigating the challenges, myths, and common misperceptions of initial VRE deployment can be found in IEA (2017a).

Refined evaluation and measurement of energy access

Governments and the donor community are increasingly aware that setting and achieving meaningful energy access goals require a robust means of both defining and tracking progress towards access against a broad spectrum of possible energy end uses. With the understanding that access to energy is not the end goal itself, but rather a means to enable socioeconomic development, energy access efforts are now being further qualified with an emphasis not only on ensuring access to energy, but also on ensuring access to *reliable, sufficient and affordable* (and, increasingly, *clean*) energy.

For example, in the past, a household with a small solar home system (SHS) capable of powering two light bulbs and a radio may have been considered “electrified”. Alternatively, a household may be “connected” to the grid but receive only intermittent and unreliable power for just a few hours a day. Hence, the focus is shifting amongst governments, donors, developers and other actors to consider and address the full spectrum of productive end-uses of energy.

Perhaps the most widely recognised manifestation of this is the World Bank and SE4ALL’s *Multi-Tier Framework* for measuring energy access, which outlines six increasing tiers of energy access, based on factors such as the available energy capacity, duration and outage frequency (ESMAP, 2015). The Global Lighting and Energy Access Partnership (Global LEAP), an initiative of the Clean Energy Ministerial, has promulgated a quality assurance framework for mini-grid investments, which provides a basis to define tiers of end-user service, and provides a clear process for performance reporting and promoting accountability (Baring-Gould et al., 2016).

With this increased awareness, governments and donors can better define minimum service standards that qualify a household as “electrified”, or energy regulators and government departments can set tiered tariffs and subsidies that are representative of the quality of service that newly electrified consumers are receiving.

Evolving roles, actors and interests

Increasing participation of the demand side through market, policy and regulatory reforms

The demand side is increasingly able to participate in the power sector through greater customer awareness of prices, combined with advances in technology on the one hand, and new policy, regulatory and market paradigms on the other. This presents a substantial opportunity to reduce system costs, promote cost-effective VRE integration, and yield value for both retail and

wholesale energy users. This issue is discussed in further detail in the policy, market and regulatory frameworks section of Chapter 4.

Greater private-sector participation in dynamic electricity markets

Page | 22

In dynamic electricity markets where electricity demand is growing, governments are increasingly shifting institutional frameworks to encourage more private-sector investment and reduce energy costs. These transitions can be incremental in nature, or happen more rapidly depending on local conditions. Furthermore, they may involve only slight tweaks to institutional frameworks, or foment more transformational change.

Mexico has pursued a relatively accelerated path of market reform, restructuring from a vertically integrated state-owned paradigm with limited private-sector ownership, to a deregulated wholesale power market in less than five years (Shah et al., 2016).

Egypt recently passed legislation to liberalise the generation and distribution market segments, allowing private-sector participation in the electricity market for the first time. This process will occur over an eight-year transition period. In Colombia, where a deregulated power market already exists, the government is currently considering regulatory reforms to encourage private-sector investment in wind and solar energy, which might otherwise not occur due to market design factors (CCEE, 2017).

Innovative support for low-income customers through rooftop solar programmes

While rooftop solar has traditionally been available only to those who can afford it, plummeting solar costs and evolving discussions around reform of utility business models and regulation are driving some utilities and regulators to explore rooftop solar programmes explicitly designed to benefit the poor. This is particularly the case in emerging and developing countries, in areas with weak distribution grids or very limited electricity infrastructure. Rooftop solar systems are being deployed on the roofs of low-income customers, with the utility providing a rooftop rental payment and often free electricity or bill credit to the customer.

For instance, a public-private partnership “Rent-a-Roof” programme in Gujarat, India, is providing a rooftop rental payment to a range of private customers, ranging from commercial and industrial to residential, including low-income residential customers (IFC, 2012b).

Mexico is also considering a national programme which repurposes electricity tariff subsidies and instead provides lower-income customers with a highly subsidised rooftop solar system (LARCI, 2015).

But this trend is not limited to low-income countries. The New York utility, National Grid, has launched a pilot programme to install rooftop solar on 100 homes in a low-income neighbourhood in the town of Buffalo, providing bill credits of between USD 15 and USD 25 per month to participating customers, while adding the capital expenditure to their regulatory revenue requirement (National Grid, 2016). Notably, the utility-owned distributed rooftop solar systems will also be used on a pilot basis to provide reactive power support to the local grid.

Emerging investment frameworks

Increasingly system-friendly procurement of VRE resources

Procurement mechanisms for VRE resources have traditionally encouraged selection of sites and technical designs that minimise generation costs and maximise generation output for individual projects, without consideration of the expected technical or economic impact on the rest of the

power system. As VRE penetration approaches 20% to 30% share in many markets, governments are increasingly creating investment signals which steer site selection to areas that are more “system friendly”, which suit the grid (IEA, 2016b).

Another emerging mechanism to increase the system-friendliness of VRE projects is to include provisions in grid codes and contracts that require wind and solar generators to provide grid services, such as frequency and voltage regulation, both during normal operations and during disturbances (O’Neill and Chernyakhovskiy, 2016). Chapter 3 on VRE integration provides additional information on this.

Evolving regulatory frameworks for encouraging investment in DER

Regulatory incentives are driving distribution utilities to weigh traditional upgrades to grid capacity against emerging alternatives – namely, investing in grid intelligence, energy efficiency, demand response, or various forms of DER, including decentralised generation and storage.

This adds to the uptake of DER by all types of end user. Investment in decentralised generation technologies, rooftop solar PV in particular, can transform end users into “prosumers” who actively manage their own production and consumption of energy. In Australia, for example, more than 20% of households are equipped with a rooftop solar PV system (APVI, 2017). The subsequent shift in the historic balance of supply and demand in low- and medium-voltage grids, and its importance for power system transformation, is discussed in greater detail in Chapter 4.

Distribution utilities in the United Kingdom, under RIIO (Revenue=Incentives+Innovation+Outputs) performance-based regulation, are increasingly encouraged to propose innovative DER pilot programmes, facilitate institutional learning and utilise third-party DER providers to improve reliability and reduce connection times (Ofgem, 2017). The regulator in the US state of New York is encouraging distribution utilities to defer capital investments by identifying “non-wire alternatives”, providing customised financial incentives to utilities who propose innovative and lower-cost DER alternatives (Walton, 2016). In Australia, all proposed grid investments by distribution utilities over AUD 5 million must be proven cost-effective relative to alternatives, including DER strategies (Sprinz, 2017).

Reduced investment potential in wholesale power markets with static demand

In certain developed countries with wholesale power markets, energy prices are in decline due to a variety of factors. These include excess capacity, flat or decreasing electricity demand, low prices for fuel commodities and increasing penetration of low marginal cost resources, such as wind and solar. This is leading to reduced investment potential for new power generation projects, more difficult financial conditions for existing power plants, and in some circumstances, concerns about security of supply as some generators exit the market.

For instance, the Nord Pool market in Scandinavia is currently characterised by an abundance of energy, resulting from a number of factors such as an increase in generation capacity due to a joint green certificate scheme between Norway and Sweden, sluggish demand growth and increased imports from continental Europe during periods of abundant supply there. This has caused the state-owned developer, Statkraft, to reconsider development of a wind power project with a capacity of 1 000 megawatts, a project later revived using new economic and design parameters (Wind Power Monthly, 2015, 2016).

In some deregulated markets, such as the United States and Sweden, low prices are not only affecting generation resources with high marginal costs, but also low-carbon resources with low fuel costs, such as nuclear power plants, in some cases leading to early plant retirement (Szilard et al., 2016). Natural gas plants, which over the past five years have experienced closures

throughout Europe, are also beginning to experience difficulty in California and Texas (Tweed, 2014; Walton, 2017; Gifford and Larson, 2017). These issues are discussed in greater detail in Chapter 4 on policy, market and regulatory frameworks.

Responses to changing market conditions and technology drivers

Page | 24

Increasing flexibility of thermal generation fleets

Increasing penetration of VRE resources is, in many circumstances, creating the need for more flexible power systems capable of responding to steeper and/or more frequent changes in net demand. Conventional power plants are a key source of flexibility, in particular hydropower and thermal plants. Hydropower plants are recognised as being highly flexible, while a large number of thermal plants have traditionally been operated without substantial or frequent changes to output.

Thermal generators offer significant flexibility potential, but this potential often goes unrealised for a variety of reasons, both technical and institutional in nature. However, thermal generation is now providing flexibility in leading clean energy transition countries, such as Denmark, Germany, Spain and parts of the United States. This flexibility is occurring through physical retrofits, changes to operational practices and standards, and modifications to generation contracts. This trend and examples of flexible thermal plants are also discussed in Chapter 3.

Increasing cross-border co-ordination and power sector integration

Co-ordination between neighbouring balancing areas to optimise power system operations across borders can result in significant cost savings, and can reduce the flexibility requirements needed to integrate larger shares of VRE. Neighbouring power systems in the western United States and much of Europe are increasingly moving towards greater co-ordination and consolidation of power system operations, to increase the geographic footprint of balancing areas. The Nordic balancing market provides a good example.

An initiative is also currently under way in the Association of Southeast Asian Nations (ASEAN) region to create a regional power grid with integrated system operations (IEA, 2015). This development and examples of policy and regulatory mechanisms to improve balancing area co-ordination are discussed in greater detail in Chapter 4.

Relying on stand-alone, small-scale power systems for providing rural energy services

Governments across much of the developing world are increasingly beginning to embrace the use of isolated power systems and mini-grids as an effective means of providing access to modern energy services to unelectrified communities – particularly in geographically remote areas. Until recently, electrification had often been perceived as the responsibility of national utilities in the form of extension of transmission and distribution infrastructure. Deployment of SHS and mini-grids, although gaining traction, was more often than not left to the non-governmental organisation and donor community, frequently with little oversight. In the past several years, however, an increasing number of governments have begun actively encouraging widespread adoption of mini-grids as a long-term means of providing rural energy services that can complement rather than compete with the grid.

Mali, one early adopter, has stimulated a vibrant market and now boasts over 160 mini-grids, supported by a flexible enabling environment that allows private-sector actors to pursue multiple

avenues for projects, and grants them the ability to set their own commercially viable tariffs (Walters et al., 2015).

Indonesia, having increased its national electrification rate from 70% to over 90% in the last five years alone, has recently announced the goal of facilitating development of 2 500 mini-grids to help reach the remaining customers. It has begun the requisite process of regulatory reform intended to open the mini-grid market to private-sector development (Susanto, 2016).

Kenya, meanwhile, with support from the World Bank, is launching a USD 150 million initiative to deploy solar-powered mini-grids to communities across the country (Waruru, 2017). The example of Kenya is further indicative of the broader trend of expanded use of renewable energy in mini-grid applications, particularly as a means to reduce dependence on costly diesel fuels (IRENA, 2016).

Evolving public policy and regulatory strategies

More ambitious targets for renewable energy deployment

Many countries and subnational governments have stepped up their goals and targets for the deployment of renewable energy and its integration into power systems. Following rapidly declining costs of renewable energy, and increasing familiarity and experience with relevant technologies, countries are gaining confidence that renewables can be a reliable and cost-effective source of energy while contributing to climate and development goals.

The Paris Agreement, the United Nations' cornerstone climate change mitigation agreement, which has been ratified by more than 130 countries, has driven governments to include ambitious renewable energy goals in their Nationally Determined Contributions. Cape Verde and Samoa, for example, aim to achieve 100% renewably sourced electric power generation by 2025 (Climate Policy Observer, 2017). India established an ambitious national target to install 100 gigawatts (GW) of solar and 60 GW of wind power capacity by 2022. Achieving India's renewable energy goals will help address mounting air pollution and climate change risks, as India's government seeks to improve energy access for the country's nearly 300 million people without adequate access to electricity (Mittal, 2015).

Meanwhile, Chile's government recently announced a goal to produce 70% of power from renewables by 2050, and the US state of Hawaii aims to have 100% clean energy by 2045 (Ryan, 2016; Hawaii Governor's Office, 2015). In addition, experiences from countries such as Portugal, where renewable sources provided 58% of electricity produced in 2016, will continue to encourage decision makers to pursue even more ambitious goals (APREN, 2017).

It is worth noting that not all cases have a plan or roadmap available on how to achieve their aspirations. Some of these goals are highly ambitious and reaching them is likely to require a substantial amount of effort and determination. In particular, the reliable and cost-effective integration of rising shares of wind and solar power requires sufficient institutional and technical capacities; close international collaboration will be critical to turn ambitions into reality.

Increasing competitive procurement of VRE

Governments and utilities in many parts of the world are increasingly using competitive procurement mechanisms to attract competition and drive down the cost of VRE; this trend is occurring in markets with a diversity of institutional frameworks, including those with wholesale power markets. These competitive procurement mechanisms still offer long-term power purchase contracts, but the ultimate contract price is discovered through competition. Recent experiences in Mexico, India, Chile and the United Arab Emirates point to the success of well-

designed competitive procurement frameworks in discovering new lows for unsubsidised, utility-scale solar PV costs. This aspect and relevant examples are discussed in greater detail in Chapter 4.

Value-based remuneration for DER customers

Page | 26

With increased adoption of and falling costs for DER, particularly customer-sited solar PV systems, many jurisdictions are beginning to move away from traditional compensation mechanisms (i.e. net energy metering, feed-in tariffs, net billing) and towards DER remuneration schemes that more closely reflect the value of DER energy on the grid. The different valuation methodologies and examples are discussed in further detail in the topical focus on local grids in Chapter 5.

Greater investment and incentives for vehicle electrification

The EV industry is rapidly developing in China, Europe and North America. Private and public investment in EV charging infrastructure complements incentives from regulators and utilities for the adoption of EVs. Ambitious targets and policy support have lowered vehicle costs, extended vehicle range and reduced consumer barriers in a number of countries (IEA, 2016c).

Norway, where EVs account for more than a quarter of new car sales, has installed a network of high-quality charging stations and offers EV drivers generous incentives and access to bus lanes (Salisbury and Toor, 2016). China provides a range of tax and financial incentives to both EV customers and industry (Perkowski, 2016). Certain utilities in the United States are also making direct investments in EV charging infrastructure. Three Californian utilities recently proposed a combined USD 1 billion in EV infrastructure projects and incentives (Trabish, 2017).

Utilities see EV adoption as a source of growth in electricity demand and in new revenue via billpayer-funded capital expenditure on charging infrastructure. In Germany, where incentives are geared towards the ambition of putting 1 million EVs on the road by 2020, plans are under way to reuse old EV batteries in energy storage and demand-response applications. A 13 MWh system that relies on “second-use” EV batteries is currently operating as a demonstration project at a recycling facility in Lünen, Germany (PV Magazine, 2016).

Adoption of new end-use technologies

A variety of emerging end-use technologies are pushing the frontiers of power system transformation around the world. In many cases, these end-use technologies can enable greater flexibility in power systems and lead to higher demand for clean generation sources, such as variable wind and solar. EVs, heat pumps, and smart and efficient buildings are three such representative examples outlined below. At the same time, the uptake of these technologies is bound to increase the complexity of overall grid operations. It thus requires new approaches to system operation and planning to ensure that these trends contribute to clean, reliable and affordable power systems.

EVs

EVs use batteries to store electrical energy that propels the vehicle using highly efficient motors instead of combusting a fossil fuel. They may be battery-electric vehicles (BEVs), or plug-in hybrid electric vehicles (PHEVs) that use both electric and traditional internal combustion engines in tandem. Certain definitions also include fuel cell vehicles that make electricity on board from hydrogen, which could be produced from a variety of sustainable methods (NREL, 2017).

Passenger EV sales have been growing rapidly in North America, Europe, Asia and other regions since 2012, with a cumulative two million plug-in vehicles sold by the end of 2016 (IEA, 2017b). This remains a small share of the total global vehicle stock (0.85%), but exponential growth is occurring in many markets. It is also worth noting that the number of electric two-wheelers on the road is significantly higher than the number of EVs, with more than 200 million units already currently in circulation, mostly in China (IEA, 2016e).

The primary enabling function of EVs in power system transformation relates to intelligent charging, responding to when the grid has abundant generation available. Fleets of EVs can absorb excess VRE when it is available, for example through smart charging protocols. They can also serve to balance load, reducing the need for often-expensive peaking generation capacity. EVs, by serving as a new source of consumer demand, could also help overcome the difficulties that utility business models face with growing use of rooftop solar and other distributed energy resource options that affect their revenues.

It is also worth noting that the widespread deployment of EVs without smart charging technology could create new challenges for system operators if low-voltage power lines become overloaded, or if charging occurs *en masse* during peak hours.

As power grids become less carbon intensive through the continuous deployment of VRE and other clean generation sources, the greenhouse gas and other environmental benefits of EVs (and other electrified end-use technologies such as heat pumps) also improve, creating a positive feedback loop, as shown in Figure 2.5.

Figure 2.5 • Positive feedback between declining grid-based carbon intensity and electrified end uses

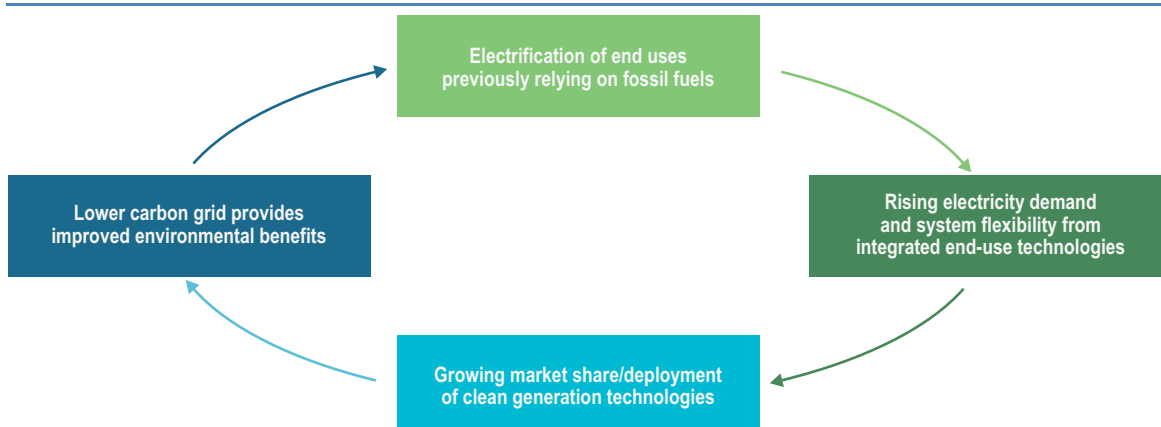

Key point • As electricity supply becomes increasingly decarbonised, the benefits of electrification grow with positive feedback.

In the Netherlands, the “Living Lab Smart Charging” project is a large-scale open platform to support adoption of smart charging and vehicle-to-grid technologies. EV owners can earn money by allowing their vehicles to be charged according to a combination of their needs and what the grid needs (Lambert, 2016). In San Francisco, Pacific Gas & Electric and BMW have just started the second phase of a smart charging project that allows participants to choose different priorities for charging vehicles and adjusting charging depending on the level of renewables on the grid (PG&E, 2016).

Smart and efficient buildings

Globally, buildings account for about 40% of total primary energy demand (IEA, 2013). New approaches to building design, operation and management, information technology and end-use

technology offer substantial opportunity to lower energy use with improved comfort, health and safety for building occupants.

Smart and efficient buildings can also enable power system transformation by providing flexibility to the grid through aggregated demand response, reduced peak loads and engaged energy consumers. End-use technologies include controllable thermal loads, such as air conditioners, heat pumps (see next section) or electric water heaters. Efficiency gains through improved appliances and other technologies, such as light-emitting diode (LED) lighting, are only part of the changes occurring in smart and efficient buildings – information and communication technology advances enable automation of buildings that can result in whole-building optimisation.

In Hawaii, smart electric water heaters have been employed under a smart home energy management programme, allowing residential customers to store excess solar energy during the day for later use. This management programme uses a battery and smart electric water heater to automatically modify energy usage based on the amount of solar power available (SolarCity, 2016).

Drivers behind the adoption of smart and efficient building features include codes and standards, technological innovation and incentives for market entry of energy service providers. Deemed the smartest and greenest office building in the world, the Edge in Amsterdam contains 28 000 sensors to control building features for each employee according to their individual preferences and assigns office space to each on arrival every day.

Heat pumps

In 2015, energy demand for heating and cooling services in buildings accounted for 32% and 5%, respectively, of global final energy use (IEA, 2017c). Fossil fuels account for three-quarters of the total global energy used for heat (REN21, 2016). In colder regions, such as Europe and Canada, heating accounts for more than half of total final energy demand. Electric heat pumps have the potential to displace fossil fuels and provide highly efficient delivery of heating and cooling services. Heat pumps use a refrigeration cycle that transfers heat from a source (the ground, ambient air, or bodies of water) to a sink (buildings) to provide heating services, and the opposite for cooling services. They achieve high efficiency because they gather and move heat rather than burn fuel to create it.⁴ Heat pumps can also provide domestic water heating services.

As with smart electric charging of vehicles, electric heat pumps can be aggregated to provide additional flexibility to the power system. They do this by delaying or accelerating heating and cooling depending on grid conditions, utilising the thermal storage inherently available in the residences or facilities they serve. And as with EVs, by serving as a growing source of demand they can help address lost revenues at utilities whose service areas include growing quantities of distributed energy resources. By the same token, electric heat pumps can lead to lost revenue, and potentially stranded assets, in the fossil fuel sector.

Both ducted and split system heat pumps have seen strong growth in Europe, Asia and the Americas, although market data can be difficult to find. As electricity grids become increasingly decarbonised, with higher amounts of renewables and other low-carbon generation, heat pumps can achieve significant savings in both energy demand and carbon emissions. In addition, heat

⁴ Heat pump efficiency is typically measured as the “coefficient of performance”, the ratio of power output divided by power input. Heat pumps are able to achieve efficiencies greater than 100% because they move heat rather than create it. Air source heat pumps typically have a coefficient of 2.5 to 3.0, while ground source heat pumps, which rely on more constant and moderate underground sources of heat, can achieve a coefficient of up to 6.0. Significant improvements in air source heat pumps have been achieved over the past decade, allowing them to be effective at temperatures down to -25° C (Siegenthaler, 2016). Recent improvements in variable-speed compressor pumps and subsystem integration have driven these changes.

pumps are used to increase flexibility as part of district heating systems by making use of their underground storage capacities.

One barrier to the expansion of heat pump systems is their investment costs, which are often higher than those for fossil fuel alternatives. This has the potential to change as greater economies of scale are achieved in manufacturing of components and as improved energy efficiency of buildings enables smaller systems to achieve desired results.

France and the United States offered certain purchasers of heat pumps a tax credit equal to 30% of the upfront cost until the end of 2016, while Germany and Austria have offered special electricity tariffs for heat pump owners (Bergman, 2016; Nowak, 2009). In its “Real Value” project, the European Union is studying the potential to electrify more of the heating load in aggregated, small-scale residential uses by introducing power-to-heat storage devices that can provide flexibility to the grid (Grandell, Simila and Koreneff, 2016).

These are some of the technologies that can help enable greater use of VRE sources (discussed next in Chapter 3) and influence the planning and operation of local grids (Chapter 5). Other technologies and practices are likely to emerge to further influence issues relating to VRE and the evolution of the local grid.

References

- APREN (2017), *Produção de Eletricidade por Fonte Em 2016* [Power Production by Source in 2016], Associação de Energias Renováveis, <http://apren.pt/pt/dados-tecnicos-3/dados-nacionais-2/producao-2/a-producao-de-eletricidade-em-portugal-3/producao-de-eletricidade-por-fonte-em-2016/> (accessed 2 March 2016).
- APVI (2017), *Solar Map*, Australian PV Institute, www.pv-map.apvi.org.au.
- Bacon, R. (1995), “Privatization and reform in the global electric supply industry”, *Annual Review: Energy and the Environment*, Vol. 20, pp. 119-43.
- Baring-Gould, I. et al. (2016), *Quality Assurance Framework for Mini-Grids*, National Renewable Energy Laboratory, Golden.
- Bergman, L. (2016), *Wave of New, Renewed, and Extended Incentives to Improve Heat Pump Prospects in Europe*, Delta Energy and Environment, www.delta-ee.com/delta-ee-blog/wave-of-new-renewed-and-extended-incentives-to-improve-heat-pump-prospects-in-europe.html.
- Borenstein, S. and J. Bushnell (2015), *The U.S. Electricity Industry after 20 Years of Restructuring*, University of California, Berkeley, <https://ei.haas.berkeley.edu/research/papers/WP252.pdf>.
- Castalia (2013), *International Experience with Single Buyer Models for Electricity*, Castalia, www.castalia-advisors.com/files/updated_2014/castalia-review-international-experience-single-buyer-models.pdf.
- CCEE (2017), *CREG – Energía Renovable – Documento en Consulta Pública* (news release), Consejo Colombiano de Eficiencia Energética, www.cceecol.org/index.php/noticias/171-creg-energiarenovable.
- Climate Policy Observer (2017), *Intended Nationally Determined Contribution (INDC)*, Climate Policy Observer, <http://climateobserver.org/open-and-shut/indc/>.
- EIA (2010), *Status of Electricity Restructuring by State*, US Energy Information Administration, Washington, DC, www.eia.gov/electricity/policies/restructuring/.

- ESMAP (2015), *Beyond Connections: Energy Access Redefined*, World Bank Group Energy Sector Management Assistance Program, Washington DC.
- Gifford, R. and M. Larson (2017), *State Actions in Organized Markets: Continued Use of 'Around Market' Solutions to 'Fix' Markets and the Natural Gas Conundrum*, Wilkinson, Barker and Knauer, LLP, www.wbklaw.com/uploads/file/White%20Paper%20-%20Market%20Design%20Issues%20FINAL.pdf.
- Grandell, L., L. Simila and G. Koreneff (2016), *Role of SETS in Evolving European Energy System*, VTT Technical Research Centre of Finland Ltd., www.realvalueproject.com/images/uploads/documents/Role_of_SETS_in_Evolving_European_Energy_System.pdf.
- Gratwick, E. and A. Eberhard (2008), "Demise of the standard model for power sector reform and the emergence of hybrid power markets", *Energy Policy*, Vol. 36, pp. 3948-3960, Elsevier, Amsterdam.
- Hawaii Governor's Office (2015), "Governor Ige Signs Bill Setting 100 Percent Renewable Energy Goal in Power Sector" (press release), Governor of the State of Hawaii, 8 June, <http://governor.hawaii.gov/newsroom/press-release-governor-ige-signs-bill-setting-100-percent-renewable-energy-goal-in-power-sector/>.
- IEA (International Energy Agency) (2017a), *Getting Wind and Sun onto the Grid: A Manual for Policy Makers*, OECD/IEA, Paris.
- IEA (2017b), *Global Electric Vehicle Outlook*, OECD/IEA, Paris.
- IEA (2017c), "Tracking clean energy progress 2017", excerpt from *Energy Technology Perspectives 2017*, OECD/IEA, Paris.
- IEA (2016a), *Re-powering Markets: Market Design and Regulation during the Transition to Low-Carbon Power Systems*, OECD/IEA, Paris.
- IEA (2016b), *Next Generation Wind and Solar Power*, OECD/IEA, Paris.
- IEA (2016c), *World Energy Outlook 2016*, OECD/IEA, Paris.
- IEA (2016d), *Global EV Outlook*, OECD/IEA, Paris.
- IEA (2016e), *Energy Technology Perspectives 2016: Towards Sustainable Urban Energy Systems*, OECD/IEA, Paris.
- IEA (2015), *Development Prospects of the ASEAN Power Sector*, OECD/IEA, Paris.
- IEA (2013), *Modernising Building Energy Codes to Secure our Global Energy Future*, OECD/IEA, Paris.
- IEA (1999), *Lessons from Liberalised Electricity Markets*, OECD/IEA, Paris.
- IFC (2012a), *From Gap to Opportunity: Business Models for Scaling up Energy Access*, International Finance Corporation, Washington, DC.
- IFC (2012b), *Public-Private Partnership Stories: India: Gujarat Solar*, International Finance Corporation, Washington, DC.
- Impact Amplifier (2017), *Energy Provision at the Base of the Pyramid: Are There Viable Business Models to Serve South Africa's Low-Income Communities?*, www.impactamplifier.co.za/wp-content/uploads/2017/02/BOP_Final.pdf.

- IRENA (2016), *Innovation Outlook: Renewable Minigrids*, International Renewable Energy Agency, www.irena.org/DocumentDownloads/Publications/IRENA_Innovation_Outlook_Minigrids_2016.pdf.
- Joskow, P. (2003), *Electricity Sector Restructuring and Competition: Lessons Learned*, Massachusetts Institute of Technology, Cambridge, <http://ceepr.mit.edu/files/papers/2003-014.pdf>.
- Joskow, P. and R. Schmalensee (1983), *Markets for Power: An Analysis of Electric Utility Deregulation*, Massachusetts Institute of Technology, Cambridge.
- Kind, P. (2013), *Disruptive Challenges: Financial Implications and Strategic Responses to a Changing Retail Electric Business*, Edison Electric Institute, Washington, DC, www.eei.org/ourissues/finance/documents/disruptivechallenges.pdf.
- Lambert, F. (2016), *Electric Vehicle Smart Charging to Go Nationwide in the Netherlands, Taking Advantage of Solar and Wind Energy*, Electrek, <https://electrek.co/2016/10/18/electric-vehicle-smart-charging-to-go-nationwide-in-netherlands/>.
- LARCI (2015), *Refocusing Subsidy to Solar Distributed Generation*, Latin America Regional Climate Initiative, www.epa.gov/sites/production/files/2015-10/documents/oscar_ibanez_refocusing_subsidy_to_solar_distributed_generation.pdf.
- Mittal, S. (2015), "India aims to achieve colossal renewable energy targets 2 years in advance", *Clean Technica*, <https://cleantechnica.com/2015/11/09/india-aims-achieve-colossal-renewable-energy-targets-2-years-advance/>.
- Moner-Girona, M. (2008), *A New Scheme for the Promotion of Renewable Energies in Developing Countries: The Renewable Energy Regulated Purchase Tariff*, Institute for Environment and Sustainability, <http://publications.jrc.ec.europa.eu/repository/bitstream/JRC43625/43625%20-%20wg4-vfinal.pdf>.
- National Grid (2016), *Implementation Plan for Fruit Belt Neighborhood Solar REV Demonstration in Buffalo, New York*, National Grid, <http://documents.dps.ny.gov/public/Common/ViewDoc.aspx?DocRefId=%7BAFABE824-60F5-4800-9D28-5FC1A69B4D83%7D>.
- Nowak, T. (2009), *Heat Pump Incentive Schemes: Experiences from EU Member States*, European Heat Pump Association, www.ehpa.org/uploads/media/EHPA_NOWAK_-_Heat_pump_subsidies.ppt.pdf.
- NREL (2017), *Hydrogen and Fuel Cell Research Website*, National Renewable Energy Laboratory, www.nrel.gov/hydrogen/proj_production_delivery.html.
- O'Neill, Barbara and Ilya Chernyakhovskiy (2016), *Designing Wind and Solar Power Purchase Agreements to Support Grid Integration*, NREL/TP-6A20-66543, National Renewable Energy Laboratory, <http://greeningthegrid.org/resources/factsheets/designing-wind-and-solar-power-purchase-agreements-to-support-grid-integration>.
- Odarno, L. et al. (2017), *Strategies for Expanding Universal Access to Electricity Services for Development*, World Resources Institute, www.wri.org/publication/strategies-access-electricity.
- Ofgem (2017), *Electricity Network Innovation Competition*, Office of Gas and Electricity Markets, www.ofgem.gov.uk/network-regulation-riio-model/network-innovation/electricity-network-innovation-competition (accessed 2 March 2017).

- Perkowski, J. (2016), “The electric car market has a ‘chicken or egg’ problem – and China is solving it”, *Forbes*, www.forbes.com/sites/jackperkowski/2016/09/26/china-electric-car-charging-station/#4ec75db7123c.
- PG&E (2016), “PG&E and BMW partner on next phase of pilot studying advanced electric vehicle charging” (news release), Pacific Gas and Electric, www.pge.com/en/about/newsroom/newsdetails/index.page?title=20161114_pge_and_bmw_partner_on_next_phase_of_pilot_studying_advanced_electric_vehicle_charging.
- PV Magazine (2016), “Study: ‘Second-life’ EV batteries to offer 1 TWh capacity by 2030”, *PV Magazine*, www.pv-magazine.com/2016/04/07/study-second-life-ev-batteries-to-offer-1-twh-capacity-by-2030_100024056/.
- REN21 (2016), *Global Status Report*, Renewables Energy Policy Network for the 21st Century, Paris.
- Reuters (2015), “Norway says wind power prospects will weather cheap electricity”, Reuters, www.reuters.com/article/norway-windpower-idUSL5N0YX31Z20150619.
- RMI (2015), *The Economics of Load Defection*, Rocky Mountain Institute, Boulder, www.rmi.org/electricity_load_defection.
- Ryan, C. (2016), “Chile introduces new energy 2050 renewable-energy goals”, PVTech, 6 January, www.pv-tech.org/news/chile-introduces-new-energy-2050-renewable-energy-goals.
- Salisbury, M. and W. Toor (2016), *How Leading Utilities are Embracing Electric Vehicles*, Southwest Energy Efficiency Project, www.swenergy.org/data/sites/1/media/documents/publications/documents/How_Leading_Utilities_Are_Embracing_EVs_Feb-2016.pdf.
- Shah, M. et al. (2016), *Clean Restructuring: Design Elements for Low-Carbon Wholesale Markets and Beyond*, Technical Report NREL/TP-6A50-66105, National Renewable Energy Laboratory, Golden.
- Siegenthaler, J. (2016), “Cold climate air-to-water heat pumps”, in *PM Engineer Magazine*, www.pmengineer.com/articles/92581-cold-climate-air-to-water-heat-pumps.
- Sioshani, F. and W. Pfaffenberger (2006), *Electricity Market Reform: An International Perspective*, Elsevier Global Energy Policy and Economics Series, Elsevier, Amsterdam.
- SolarCity (2016), *SolarCity Launches Smart Energy Home in Hawaii* (press release), www.solarcity.com/newsroom/press/solarcity-launches-smart-energy-home-hawaii.
- Sprinz, J. (2017), *Investment Note, 3 February: Grid Investment Gives Way to Distributed Energy*, Bloomberg New Energy Finance.
- Susanto, A. (2016), “Indonesia’s new rural electrification regulation”, PV-Tech, www.pv-tech.org/guest-blog/indonesias-new-rural-electrification-regulation.
- Szilard, R. et al. (2016), *Economic and Market Challenges Facing the U.S. Nuclear Commercial Fleet*, INL/EXT-16-39951, Idaho National Laboratory, <https://gain.inl.gov/Shared%20Documents/Economics-Nuclear-Fleet.pdf>.
- Trabish, H. K., (2017), “How California’s utilities are planning the next phase of electric vehicle adoption”, *Utility Dive*, www.utilitydive.com/news/how-californias-utilities-are-planning-the-next-phase-of-electric-vehicle/435493/.

- Tweed, K. (2014), "Europe mothballs 20GW of gas plants in 2013, with more to come", *Greentech Media*, www.greentechmedia.com/articles/read/europe-mothballs-20gw-of-gas-plants-in-2013-with-more-to-come.
- Walters, T. et al. (2015), *Policies to Spur Energy Access, Volume 2: Case Studies of Public-Private Models to Finance Decentralized Electricity Access*, NREL/TP-7A40-64460, National Renewable Energy Laboratory, Golden, www.nrel.gov/docs/fy15osti/64460-2.pdf.
- Walton, R. (2017), " 'Can't be half-pregnant': Power market upheavals prompt states, Feds to take action", *Utility Dive*, www.utilitydive.com/news/cant-be-half-pregnant-power-market-upheavals-prompt-states-feds-to-tak/437362/.
- Walton, R. (2016), "New York utilities seek non-wire alternatives in REV-inspired RFP", *Utility Dive*, www.utilitydive.com/news/new-york-utilities-seek-non-wire-alternatives-in-rev-inspired-rfp/414863/.
- Waruru, M. (2017), "Kenya prepares to expand solar minigrids into poorest rural areas", Thomson Reuters Foundation, <http://news.trust.org/item/20170113085050-5xf86>.
- Williams, J. and R. Ghanadan (2005), "Electricity reform in developing and transition countries: A reappraisal", *Energy*, Vol. 31: 6-7, pp. 815-844, Elsevier, Amsterdam.
- Wind Power Monthly (2016), "Statkraft revives 1GW Fosen site", Wind Power Monthly, www.windpowermonthly.com/article/1384556/statkraft-revives-1gw-fosen-site
- Wind Power Monthly (2015), "Statkraft ends 1GW Norway development", Wind Power Monthly, www.windpowermonthly.com/article/1350073/statkraft-ends-1gw-norway-development.
- Zinaman, O. et al. (2015), *Power Systems of the Future*, National Renewable Energy Laboratory, Golden, www.nrel.gov/docs/fy15osti/62611.pdf.

Chapter 3. Transforming power system planning and operation to support VRE integration

HIGHLIGHTS

- Integrating large-scale deployment of variable renewable energy (VRE) into the power system is vastly enabled by improvements in power system planning and operations.
- Challenges associated with power system operation can be addressed through technological options and changes in existing operational practices, making use of existing assets at relatively low cost.
- These options and practices can be categorised into technical and economic measures. The adoption of these measures depends on system characteristics and the penetration of VRE.
- Grid codes relevant to VRE plants are important to maintain the reliability of the power system. They need to be continuously revised to suit the evolving needs of the power system as the share of VRE increases.
- Integrated planning frameworks can play a key role in accommodating higher shares of VRE in the power system, including aspects across different supply and demand resources; integrated generation and network planning; planning between electricity sectors and other sectors; and inter-regional planning across different balancing areas.

The majority of recent trends and developments in the power sector, identified in the previous chapter, relate to increased VRE deployment. They have implications for power system transformation from the perspective of system operation and planning, and are likely to become more widespread across many jurisdictions as the share of VRE increases.

At low shares, integrating VRE into most systems does not pose any major challenges. At high shares, however, the challenges may be more prominent unless traditional power system infrastructure, operational practices and institutional arrangements are adapted to accommodate VRE supplying a large share of electricity.

Given the unique technical and economic attributes of VRE, together with the complex nature of the power system, the implications of integrating high shares of VRE are multiple and include technical, economic and institutional factors (Figure 3.1). In addition, high shares of VRE have broad implications for the power system at all timescales, ranging from several years to days, hours, minutes and seconds.

This chapter begins with technological options and operational practices that have been or can be adopted to integrate VRE into the system. This includes a deeper look at certain technical and operational options that have been adopted in many power systems. It then discusses integrated planning frameworks that account for VRE, followed by implications for planning and operation of medium- and low-voltage grids.

Issues relating with policy, regulatory and market frameworks to support VRE integration are discussed in Chapter 4.

Figure 3.1 • Different aspects of system integration of VRE

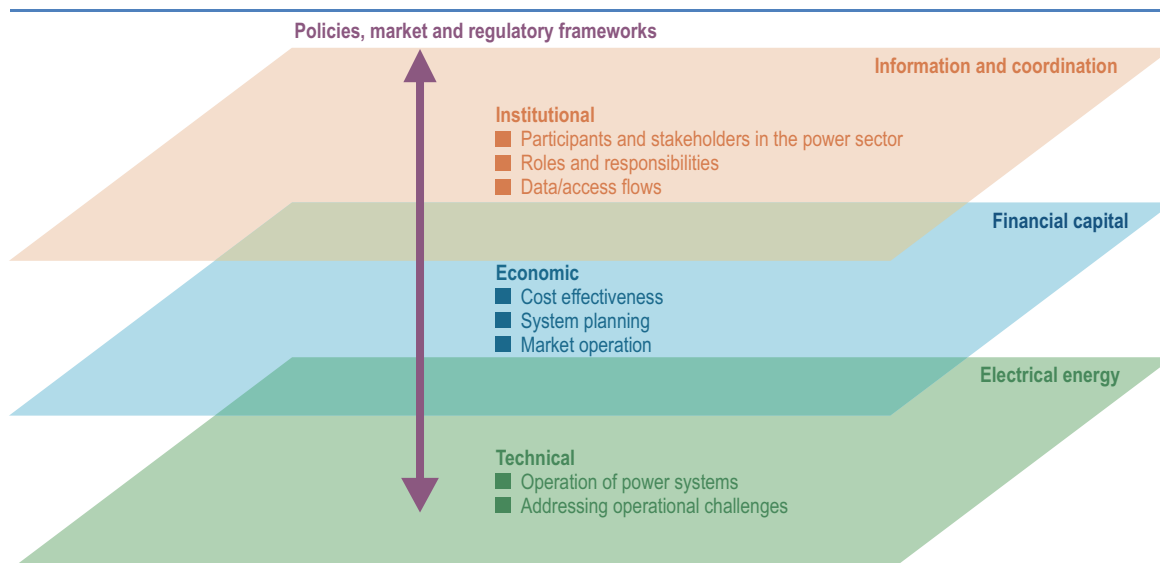

Key point • Successful VRE integration requires co-ordination across technical, economic and institutional aspects.

Challenges depend on different phases of VRE deployment

VRE generation can affect the planning and operation of the power system at all levels, from generation to transmission and distribution. Integrating VRE, particularly at high shares, in a reliable and cost-effective manner requires different approaches to traditional power system planning and operation.

The impact of and issues associated with VRE depend largely on its level of deployment and the context of the power system, such as the size of the system, its operational and market design, its regulation and its fundamentals of supply and demand.

Based on recent VRE integration experiences in many systems, four different phases of VRE deployment can be identified according to the challenges faced by the majority of power systems (Table 3.1). These phases form the basis for this section's analysis of recent trends and practices in integrating VRE.

The main characteristics at different phases of VRE deployment can be briefly described as follows (IEA, 2017):

- **Phase 1** – the system operator (SO) and other power system actors do not need to be concerned with the VRE outputs and their variability.
- **Phase 2** – the existing generation fleet will see changes in their generating pattern because of VRE. However, the system can accommodate the new situation largely with existing system resources and by upgrading certain operational practices.
- **Phase 3** – system flexibility becomes key for integrating VRE. Flexibility relates to how quickly the power system can respond to changes in the demand and supply balance in a timescale of minutes to several hours.

- **Phase 4** – the main challenge in this phase relates to stability.⁵ Technological options and improved operational practices are required to maintain power system reliability.

It should also be noted that the transition between phases does not occur abruptly from one to the other. Rather, they are a conceptualisation, intended to identify the main experiences. Issues related to flexibility will gradually emerge in phase two, before becoming the hallmark of phase three. In turn, certain issues related to system stability may already become apparent in phase three.

Table 3.1 • Operational issues relevant to different phases of VRE deployment

	Attributes (incremental as progressing along VRE phases)			
	Phase 1	Phase 2	Phase 3	Phase 4
Characterisation from a system perspective	VRE as a non-noticeable load at system level	VRE becomes noticeable at the system level to the SO	Flexibility is becoming relevant with greater swings in the supply/demand balance	Stability is becoming relevant. VRE covers significant share of demand at certain times
Impacts on the existing generator fleet	No noticeable difference between load and net load	No significant rise in uncertainty and variability of net load, but there are small changes to operating patterns of existing generators	Greater variability of net load; major differences in operating patterns; reductions in power plants running continuously	Very few power plants are running around the clock; all plants adjust output to accommodate VRE
Impacts on the grid	Local grid condition near points of connection, if any	Very likely to affect local grid conditions; transmission congestion possible driven by changes in power flows across the transmission networks	Significant changes in power flow patterns across the transmission network; increased vertical flows between networks of different voltage levels	System-wide grid strength is weakened and the ability of the grid to recover from disturbances.
Challenges depend mainly on:	Local conditions in the grid	Match between demand and VRE output, and the availability of data from VRE plants	Availability of flexible resources	System strength to withstand disturbances

Note: SO = system operator.

Source: IEA (2017), *Getting Wind and Sun onto the Grid: A Manual for Policy Makers*.

Note that the issues and challenges faced by the power system are context specific. Therefore the phase in which each system sits depends not only on the share of VRE generation, but also a number of other factors, such as the size of the system, the transmission infrastructure (including interconnectors), existing operational practices, and existing levels of flexibility (for instance, access to hydropower and pumped hydropower facilities, and connection to heating networks).

It is useful to examine international examples to illustrate the different phases (Figure 3.2).

⁵ Stability is the ability of the power system to recover from disturbances on very short time scales (a few seconds or less) and maintain the state of operational equilibrium. The size of the synchronous power system has an impact on this, with smaller systems reaching this phase earlier than those that are part of a larger system.

Figure 3.2 • Annual VRE share of generation in selected countries and corresponding VRE phase, 2015

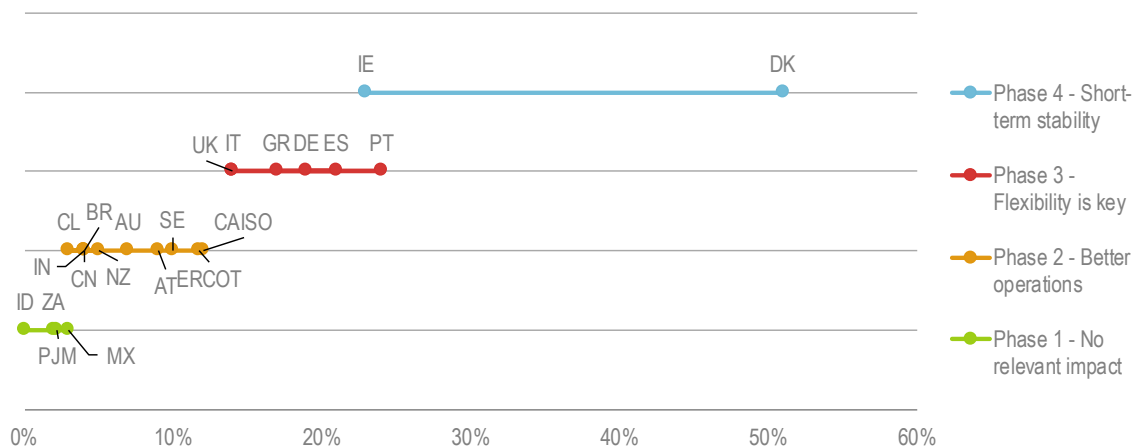

Notes: AT = Austria; AU = Australia; BR = Brazil; CL = Chile; CN = China; DE = Germany; DK = Denmark; ES = Spain; GR = Greece; ID = Indonesia; IE = Ireland; IN = India; IT = Italy; MX = Mexico; NZ = New Zealand; PT = Portugal; SE = Sweden; UK = the United Kingdom; ZA = South Africa. PJM, CAISO and ERCOT are US energy markets.

Source: Adapted from IEA (2016a), *Medium-Term Renewable Energy Market Report 2016*.

Key point • Each phase can span a wide range of VRE share of generation; there is no single point at which a new phase is entered.

Technological options and operational practices to address operational challenges of VRE

Power system challenges associated with VRE can be addressed through technological options and/or adjustments to operational practices.

A range of measures have been implemented by many power systems worldwide to mitigate the impact of VRE. These mitigation measures can be categorised into technical and economic measures. Technical measures can help to enhance the reliability of the power system, while economic measure can improve the cost-effectiveness of power system operation (Table 3.2).

These measures, which are needed at different times depending on the VRE deployment phase, are described in the following sections. Note that this is not a comprehensive list; rather these options have been used recently in power systems to address integration challenges.

Note also that the technical measures that can be used to address some of the challenges in the later phases of VRE deployment are briefly mentioned here, with the details of such measures explained in Annex A.

Table 3.2 • Technological options and operational practices for different phases of VRE deployment

Type	Measures	Phase 1	Phase 2	Phase 3	Phase 4
Technical	Real-time monitoring and control		■	■	■
	Enhancing capacity of transmission lines		■	■	■
	Power plant flexibility			■	■
	Special protection scheme			■	■
	Advanced VRE technologies and design			■	■
	System non-synchronous penetration (SNSP) limit				■
	Inertia-based fast frequency response (IBFFR)				■
	Smart inverter				■
	Advanced pump hydro operation				■
	Grid level storage				■
Economic	Integrating forecasting into system operations	■	■	■	■
	Incorporating VRE in the dispatch	■	■	■	■
	Sophisticated sizing of operating reserves		■	■	■
	Faster scheduling and dispatch		■	■	■
	Co-ordination across balancing areas			■	■

Key point • The appropriate technological options and operational practices for managing VRE integration depend on the level of VRE deployment.

Technical measures

Technical measures to address operational challenges arising from VRE will be relevant from Phase 2 of VRE deployment. Although, the main purpose of the technical measures is to address reliability issues, some of these measures can also increase the cost-effectiveness of power system operation.

Real-time monitoring and control of VRE by the system operator

The ability to monitor and control VRE plants in real time is important for secure operation of the power system, particularly as the VRE share increases and the size of VRE plants becomes relatively large. This is important for system reliability from Phase 2 of VRE deployment.

Depending on market arrangements (central dispatch versus self-dispatch), this control will either be exercised directly by the SO or through generators. Irrespective of the precise arrangements, it is critical for the SO to have real-time awareness of VRE generation and an effective mechanism for control of VRE.

Since the impact of VRE at low shares is minimal, requirements for VRE plants to be visible and controllable have not been a priority for many countries during Phase 1 of VRE deployment. This is particularly the case if VRE is connected to distribution grids and very small in size. This results in very limited visibility of and controllability over VRE plants.

Visibility and controllability will enable transmission system operators (TSOs) and/or VRE plant owners to dispatch VRE generation to suit system conditions, including during emergency conditions. The ability of VRE plants to automatically adjust their generation set point in response to control signals opens the opportunity to provide frequency regulation services, including those

via automatic generation control (AGC). The visibility and controllability of VRE plants are made possible by appropriate communication and control technologies, such as supervisory control and data acquisition (SCADA) systems.

Reflecting rising shares of VRE and the transition to advanced integration phases, visibility and controllability features have increasingly been integrated in many systems, particularly those where VRE is becoming a prominent source of electricity generation. One country that has made a substantial effort to enable the SO to have the capability of monitoring and controlling VRE plants is Spain (Box 3.1).

Box 3.1 • The Control Centre of Renewable Energies in Spain

In Spain, Red Eléctrica de España (REE) established a Control Centre of Renewable Energies (CECRE) in 2006, a globally pioneering initiative to monitor and control renewable generation using real-time information. Through the CECRE, the SO receives the telemetry of 98.6% of the wind power generation installed in Spain every 12 seconds, of which 96% is controllable (with the ability to adapt its production to a given set-point within 15 minutes).

This has been achieved through the aggregation of all the distributed resources of more than 55 megawatts (MW) in renewable energy sources control centres (RESCCs), and the connection of RESCCs with CECRE. This hierarchical structure, together with the software applications developed by REE, is used to analyse the maximum wind power generation that can be accepted by the system. Monitoring and controlling VRE generation in real time decreases the number and quantity of curtailments, maintaining the quality and security of the electricity supply at the same time that renewable energy integration is maximised.

Tools and techniques for enhancing transmission line capacity

Increased VRE penetration, particularly at locations where the grid is not strong, can exacerbate congestion in the network. Although congestion can have economic impacts in the form of possible curtailment or higher local pricing, it can also pose risks to the reliability of the system. Multiple options exist that may solve the issue, including grid reinforcement, demand management, targeted generation, or storage, but these may not be economically attractive.

Cost-effective options are available to strengthen weak spots and better utilise transmission capacity without large-scale grid reinforcement. Typical measures are dynamic line rating (DLR), flexible alternating current transmission system (FACTS) devices and phase shifters. These measures can be adopted during Phase 2 of VRE deployment. These options have been used to great effect in many systems, such as Australia, Ireland, Japan, Spain, Sweden, Thailand, the United Kingdom and the United States (US DOE, 2012a; AEMO, 2014). These measures are explained in Annex A.

Other measures involve reconducting, using high temperature low sag (HTLS) conductors, and voltage uprating of the transmission line to the next standard voltage level. These options, however, are considered relatively expensive and complex to undertake since they involve construction crews working on transmission lines (Holman, 2011).

Power plant flexibility

Flexible power plants are considered a source of flexibility that helps to address the challenges in system operation, beside grid infrastructure, storage and demand-side integration (IEA, 2014). Flexible power plants are important as a system progresses through Phase 3 of VRE deployment.

Power plant flexibility has three dimensions: adjustability, ramping and lead time. The extent to which different generation technologies offer greater or lesser flexibility depends on these dimensions.

Reservoir hydropower is an example of a potentially extremely flexible, renewable energy generation technology. Open-cycle gas turbines and banks of reciprocating engines can also be highly flexible generation resources. When combined with sufficient levels of thermal storage capacity, concentrating solar power can be a flexible, dispatchable generation option in hot and dry climates, where hydropower resources are usually limited. It may therefore play a role not only in increasing the share of solar energy directly, but also indirectly in facilitating greater uptake of VRE.

By contrast, large thermal generating units have traditionally been designed with a view to operating continuously and are generally not intended to cycle up/down and operate at part load. These plants may not have particular technical limitations, but additional costs are associated with frequent cycling operation.⁶

Greater flexibility can be attained from existing large thermal plants by retrofitting. This involves equipment modifications to prevent the negative impacts of cycling.⁷ In addition to equipment modifications, changes in power plant operating procedures, such as controlled boiler ramp rates and regular inspections, can result in increased flexibility. New power plants should also take into account cycling needs during the design stage in order to mitigate long-term risks.

Currently, thermal power plants in many countries are able to offer greater flexibility by better responding to changes in net demand. Examples of increased flexibility in thermal generation can be found in Denmark, Canada, the United States, Germany (Box 3.2) and Spain. In addition, countries with a large fleet of combined-cycle gas turbines (CCGTs), such as Italy, have taken steps to make CCGTs fleet more flexible.

In the US state of North Dakota, an ongoing wind energy boom has encouraged the traditionally baseload 1 146 MW coal-fired Coal Creek Station to begin more flexible operation, as it sells power into the Midcontinent Independent System Operator (MISO) power market. By making minor equipment modifications (less than USD 5 million) and fine-tuning certain operational processes, the plant was able to reduce minimum generation level to below 300 MW and substantially increase its ramping rate (Holdman, 2016).

Box 3.2 • Coal plant flexibility in Germany

Increased share of VRE in Germany has presented challenges for existing conventional thermal plants both technically and economically. While VRE generation could cover most demand in certain periods, conventional thermal plants would be needed to meet the demand during periods of low VRE output.

However, the existing thermal generating fleet, particularly coal plants, have proved that they can operate in a relatively flexible manner. With excessive coal generation capacity, existing coal plants are increasingly being used for balancing the variability arising from VRE (Figure 3.3). To adapt to volatile supply and demand, many coal plants have been modified to be more flexible in order to achieve higher ramp throughout the day, start/stop on a daily basis and operate at much lower minimum generation. This has been achieved through modifications of equipment, software and operational practices. Coal plants can participate in the balancing markets to provide balancing for different timescales

Source: Henderson (2014), *Increasing the Flexibility of Coal-Fired Power Plants*.

⁶ Such additional costs can arise from greater wear and tear on plant components as well as increasing fuel costs due to lower fuel efficiency.

⁷ These modifications can be made on boilers, turbines, rotors and condensers with a focus on increasing thermal resilience and preventing corrosion (Cochran, Lew and Kumar, 2013).

Figure 3.3 • Generation pattern of hard-coal power plants, 2016, Germany

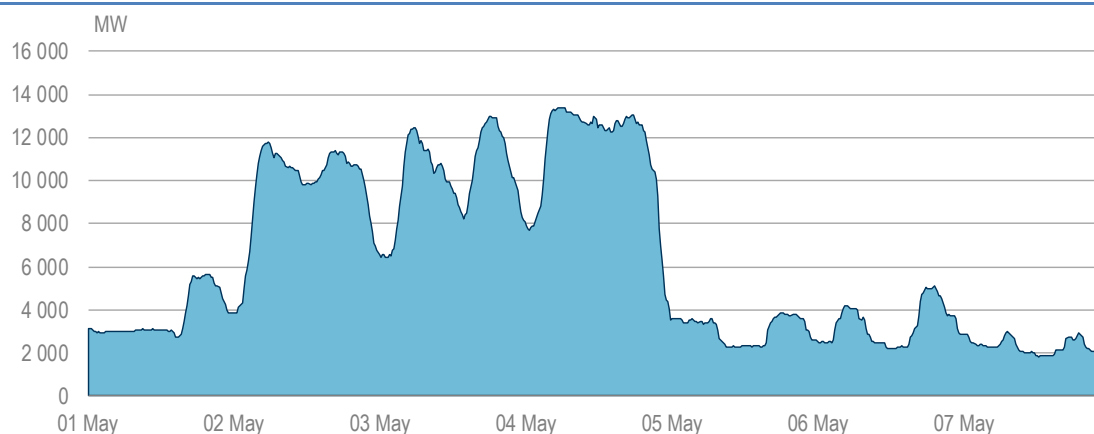

Source: ENTSO-E (2017a), *Actual Generation per Production Type*, <https://transparency.entsoe.eu/generation/r2/actualGenerationPerProductionType>.

Key point • The generation pattern of hard-coal power plants in Germany demonstrates the capability of thermal plants to cycle.

Use of special protection schemes

A special protection scheme (SPS) is used primarily to prevent voltage and frequency collapse by controlling loads, voltage or frequency to prevent an overload of transmission lines and/or equipment on the networks, such as transformers. An SPS is used predominantly to detect abnormal system conditions that can cause instability to the power system, automatically activating in response to predefined contingency.⁸ It is one of the technical measures to improve the reliability of the grid and can become a useful option during Phase 3 of VRE deployment.

SPSs have been increasingly employed in many jurisdictions where VRE is becoming a major generation source. VRE plants respond to system disturbances (both voltage and frequency) in ways that are different from conventional generators. An SPS can be implemented to maintain system stability and facilitate large shares of VRE generation.

This option represents an alternative to upgrading existing infrastructure, which can be costly and time consuming. SPS is seen as a measure that can generally increase the transfer capacity of the network and provide greater flexibility to power system operation (Miller et al., 2013). It is a cost-effective option that can be used either as a long- or short-term solution.

Chile and many jurisdictions in Europe have implemented SPSs in order to allow greater VRE onto the grid. In Europe, most SPSs have been installed to address voltage, frequency and overloading issues that may occur as a result of contingencies (De Boeck et al., 2016).

Advanced VRE technologies and design

Advanced design of solar PV and wind turbine technologies are a further example of a system-friendly VRE deployment strategy (Hirth and Mueller, 2016). It not only helps to increase the value of VRE outputs, but also reduces the challenges of power system operation as a result of less variable output and reduced forecast errors. Advanced technology for solar PV plants includes a higher direct current (DC) to alternating current (AC) ratio and tracking systems, while

⁸ The typical SPS schemes that have been employed are inter-trip and fast-runback. Inter-trip is a scheme where generators are disconnected within a very short timeframe (e.g. 100 millisecond) if a contingency would cause an overload on other lines. Fast-runback is a scheme that sends a signal to the inverters to ramp back to mitigate an overload.

changing orientations and tilt angles of solar PV panels have also been considered. Details of advanced technology for solar PV plants are discussed in Annex A.

Wind power plants tend to be built in locations with the best wind resources in order to maximise output. However, as the share of wind generation in the system increases, the concentration of wind power plants in the same geographical locations not only reduces the value of wind generation output, but can also pose challenges for system operation. Such challenges may be due to network congestion and the significant variability in overall wind power outputs due to limited geographical diversity. This issue can be addressed given advances in wind turbine technology. Advanced wind turbine technology (“low wind speed turbines”) results in turbines that are taller and have a larger rotor per unit of generation capacity.

These advanced VRE technologies can improve the reliability of the power system, particularly in the later phases of VRE deployment (from Phase 3). Details of advanced VRE technologies and design are discussed in Annex A.

Establish a limit on system non-synchronous penetration

One of the main technical issues for small and isolated power systems with high shares of VRE is low levels of synchronous inertia, which can reduce system inertia. VRE generators are usually connected to the grid via power electronic converter devices, hence the term “non-synchronous”. These generators do not have a direct, electro-mechanical coupling to the grid. This makes them different to traditional, synchronous generators. For example, they do not directly contribute to providing inertia to the power system.⁹

One measure adopted by some countries, such as Ireland, to maintain sufficient synchronous inertia is to establish the maximum limit of system non-synchronous system penetration (SNSP). This practice is important during Phase 4 as VRE becomes a major generation source. It is described in detail in Annex A.

Inertia-based fast frequency response

So-called inertia-based fast frequency response (IBFFR) is a further technical option for supplying inertia to the system that has been considered and implemented in power systems with a large share of VRE. IBFFR is also known as “synthetic” or “emulated inertia”, which can be extracted from VRE plants. IBFFR can potentially contribute to system inertia by utilising kinetic energy stored in wind turbine rotating mass. This measure can help to address frequency stability challenges during Phase 4 of VRE deployment. The TSO in Quebec, Canada is an example of a utility that has established technical requirements for physical inertia from wind power plants. Brazil and Ontario and the National Electricity Market (NEM) in Australia are also considering similar mandates. IBFFR is discussed in detail in Annex A.

Smart inverter

Traditionally, inverters were primarily designed to convert DC power generated by VRE sources to AC to be fed into the grid. However, with high shares of VRE within Phase 4, VRE plants are increasingly being required to provide additional grid support features to enable the power

⁹ System inertia acts to mitigate the rate of change of frequency (RoCoF) following a contingency event in the power system. As VRE displaces thermal generation, system inertia will be reduced, which consequently increases the RoCoF following a contingency event. RoCoF standards that have been applied in various jurisdictions range from 0.5 hertz (Hz) per second to 4 Hz/second (DGA Consulting, 2016). The standards also depend on the duration of time that VRE plants are exposed to the high RoCoF.

system to operate more reliably and cost-effectively. Smart inverters are one option to provide this. They are discussed in Annex A.

Advanced pumped hydropower operation

Pumped storage hydropower (PSH) can be an important source of flexibility in the power system. Once built, it is also considered a cost-effective option. PSH is able to provide or absorb energy according to the need of the grid. With increasing shares of VRE, there is an emerging interest in large PSH in many countries, such as India, China and Australia, in order to accommodate high shares of VRE in a cost effective and reliable manner, and to provide hourly, daily or seasonal storage and flexibility.

PSH is also capable of providing system services to maintain the reliability of the system. These services include black-start capability, ramping and quick start, spinning reserve, reactive power, inertia and frequency regulations. A number of these features would be useful for addressing reliability issues during Phase 4 of VRE deployment. Some PSH can operate in a special mode called hydraulic short-circuit pumped storage (HSCPS) to provide system inertia and frequency response. Technical aspects of PSH are discussed in Annex A.

Grid-level storage

Storage is recognised as a technology that can provide greater flexibility and help to maintain the security of the grid, particularly during Phase 4 of VRE deployment. Pumped hydropower storage currently accounts for the majority of storage deployed. Other storage technologies that have been deployed include compressed air energy storage (CAES), batteries, flywheels and liquid air storage.

For bulk power grids, storage is most often considered to relieve local congestion, which brings both reliability and economic benefits, even if prices per megawatt hour are higher than comparative generation or other options.¹⁰ As the share of VRE increases, the benefits of storage extend to system security. Certain storage technologies, such as pumped hydropower, CAES and flywheels, are capable of providing frequency response in different time scales. Grid level storage has been employed to provide system services in jurisdictions such as PJM in the United States, Italy and Chile. Note that from a system perspective, the benefits of batteries come earlier for PV than for wind. Details of grid-level storage are provided in Annex A.

Economic measures

The purpose of economic measures is to improve the cost-effectiveness of power system operation with an increasing share of VRE generation. Without economic measures, the grid would still be able to operate in a reliable manner, but is likely to be less cost-effective. Economic measures have been adopted in some systems as early as during Phase 1 of VRE deployment.

Integrating forecasting into power system operations

Advanced forecasting tools using sensing technologies, together with mathematical models, can accurately predict wind speed and solar irradiance, and subsequently forecast outputs from VRE plants on a sub-hourly basis.

Advanced forecasting is considered to be a tool that improves the cost-effectiveness of VRE integration, offering benefits as the system approaches Phase 2 of VRE deployment. It can also improve system reliability as VRE shares grow.

¹⁰ During the initial phase, there is little economic benefit of storage, as VRE has yet to affect prices on the market.

Centralised system-level forecasting of VRE generation can improve system operation by enabling the SO to account for overall variability of VRE outputs across the whole system and accurately predict the amount of VRE generation available. Forecasting is a useful tool to assist real-time dispatch, scheduling and operational planning. In self-dispatching markets, forecasting of VRE generation helps generators to establish reliable schedules and limit schedule deviations. A good plant-level forecast will allow for a more cost-effective and reliable schedule of generation. A good system-wide forecast is critical for verifying that generation schedules are feasible and sufficient operating reserves held.

Forecasts are regularly updated and are more accurate closer to real time. As the share of VRE increases, forecasting becomes an even more integral element of power system planning and operation. Examples of jurisdictions that have implemented forecasting systems to assist in system operation are Australia, Texas, California, Denmark, Germany, the United Kingdom, Ireland and Spain.

The NEM in Australia has an integrated wind and solar forecasting system, called the Australian Wind Energy Forecasting System (AWEFS) and Australian Solar Energy Forecasting System (ASEFS), as part of the generation scheduling and dispatch process. They generate forecasts for the scheduling and dispatch of generators for different time horizons, ranging from five minutes up to two years ahead. This is discussed in detail in the case study in Chapter 6.

Incorporating VRE in the dispatch

As VRE share grows, and its capability for AGC and providing other system services advances, market operators are taking advantage of advanced forecasting by actively managing VRE in the dispatch. This approach can offer benefits from later stage of phase 1 of VRE deployment.

Many systems, such as New York ISO (NYISO), Midcontinent ISO (MISO), PJM and ERCOT, have taken the step to develop levels of dispatchability for VRE to ensure better utilisation of VRE output while also maintaining system reliability (US DOE, 2012b; Madjarov and Chang, 2012). This includes incorporating VRE in the scheduling and security constrained dispatch as with other generating sources. This measure would help to improve the economics of VRE integration during the early phase, while it will help to improve the system reliability as VRE becomes the dominant generation sources. This operational practice is made possible by having appropriate forecasting systems in place.

Sophisticated sizing of operating reserves

Operating reserves are the amount of capacity that SOs can call upon to meet demand within a short timeframe. Reserves are included in system operations to deal with uncertainty in supply and demand. Generally, reserves are kept to handle contingency events, such as the loss of generation supply, or for normal operation, such as demand variation and demand forecast errors. A more sophisticated approach to determining operating reserves would improve the economics of power system operation during Phase 2 of VRE deployment.

Reserves can generally be categorised into frequency containment reserves (FCR), frequency restoration reserves (FRR) and replacement reserves (RR) (ENTSO-E, 2017b). As the name suggests, FCR limit the excursion of system frequency from its nominal range following a system event. FRR relieve containment reserves and bring frequency back to nominal levels. RR then come in to free restoration reserves.

Traditionally, the practice in many systems for establishing the size of FCR is based on the n-1 concept, i.e. being able to handle the largest single contingency in the system, either generator or transmission line.

It is important to recognise that uncertainty in VRE output is not generally correlated with supply and demand uncertainty. It is unlikely that generation outages, significant load variation and VRE variation would happen at the same moment. In addition, the uncertainties associated with VRE are different at different times of the day, and therefore the level of reserves should be dynamically adjusted to reflect these characteristics (Milligan, Denholm and O'Malley, 2012).

FRR are usually determined on the basis of a set of heuristic or, if more sophisticated, stochastic analyses of load variations, forecast errors and other factors. Large shares of VRE will bring additional, albeit different, uncertainties to the power system, and therefore more sophisticated approaches to determining appropriate levels of operating reserves are necessary to achieve cost-effective and reliable system operation. Due to the number of uncertainties associated with power system planning and operation, probabilistic approaches are appropriate for determining the operating reserve requirement for FRR and RR. These have been employed in jurisdictions such as Texas, the United Kingdom and many other European Union countries. In Spain, wind and solar forecast errors have been incorporated in reserve calculations (Box 3.3).

Box 3.3 • Use of forecast error for reserve determination, Spain

Although wind and solar power plants declare their forecasted generation, the Spanish TSO, REE, uses wind and solar power prediction tools, named SIPREOLICO and SIPRESOLAR, to predict the total hourly wind and solar production for the following 48 hours. The hourly forecasts are updated every hour and provide information for the determination of secondary, tertiary and “slow” (30 minutes to 4-5 hours) reserves.

Every day, after receiving market and bilateral contracts, REE checks the availability of running reserves for the next day. The final calculation is reached REE considering upward and downward reserve error, historic demand forecast and historic wind and solar forecast error. Reserves are revised from when the market results are received until real time.

Faster scheduling and dispatch

Scheduling and dispatch that are as close to real time as possible allow for more accurate representation of variations in net load. This results in a more efficient use of reserves, because a larger proportion of VRE variability is absorbed by schedules and hence does not need to be balanced by reserves. This operational practice can help to address economic concerns associated with VRE, from Phase 2 of VRE deployment.

For jurisdictions that have a wholesale electricity market, generation scheduling and dispatch is usually performed in time blocks, varying from 5 minutes in the fastest markets up to between 30 minutes and 1 hour in more standard designs.

For jurisdictions with a vertically integrated structure, SOs are not constrained by any market schedule and may therefore redispatch the system according to the system needs at any desired time.

The shortest dispatch interval in major electricity markets today is 5 minutes, which is implemented by most independent system operators (ISOs) in the United States and in the Australian NEM. The Electricity Reliability Council of Texas (ERCOT) is an example of a market that has achieved efficient outcomes from reducing dispatch intervals. ERCOT decided to reduce dispatch intervals from 15 to 5 minutes in 2010, resulting in less regulating reserve being required (Box 3.4).

Note that faster scheduling and dispatch can benefit the system even without VRE. However, the benefits are more apparent with higher shares of VRE.

Box 3.4 • ERCOT real-time dispatch

Page | 46

ERCOT is the ISO managing the flow of electric power to approximately 23 million Texan customers. As part of market reforms implemented in 2010, dispatch intervals were reduced from 15 to 5 minutes. As a result of the shorter dispatch intervals, significantly less regulating reserve requirements were needed (Figure 3.4).

The ERCOT market is characterised by the quasi-real-time dispatching of power plants, taking place every five minutes. In fact, in the ERCOT nodal system all generation resources, including wind resources, are given individual dispatch instructions, generally at a five-minute frequency. The security constrained economic dispatch (SCED) algorithm is primarily based on real-time telemetry data of load and production, price of energy offers and current system status.

This is made possible by the centralised control of the grid, which is characteristic of ISOs and regional transmission organisations (RTOs) in the United States. The possibility of combining – at the same time – market clearing and congestion management, in fact, circumvents the need for the redispatch process, which would require co-ordination between market players and the SO. Real-time dispatch minimises the need for reserves and allows the real-time energy price to be representative of congestion and any other challenges taking place.

The ERCOT real-time dispatch process is intended to maximise use of available wind generation, subject to the prices offered for the generation and system constraints (e.g. transmission flow constraints).

Figure 3.4 • Regulating reserve requirement in ERCOT before and after reducing dispatch intervals

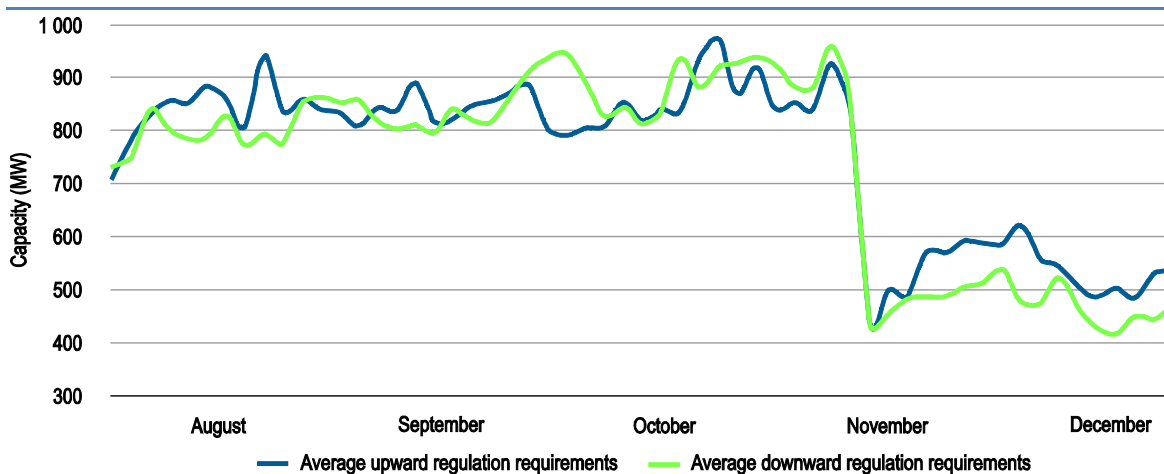

Source: IEA RETD (2015), *Integration of Variable Renewables*.

Key point • Shorter dispatch intervals can lead to more efficient reserve requirement outcomes.

Co-ordinating dispatch across balancing areas and interconnector management

The impact of the variability and uncertainty of VRE can be reduced by expanding the size of balancing areas through an inter-regional interconnector, allowing the use of imbalance netting and the exchange and sharing of reserves. This is one of the options for balancing a system with high shares of VRE in a cost-effective manner, particularly from Phase 3 of deployment.

Co-ordinating scheduling and dispatch across different balancing areas can smooth out overall variability of load and VRE outputs as a result of greater geographical and resource diversity. Weather patterns are unlikely to be well correlated across large geographical areas, while demand across different jurisdictions is unlikely to peak at the same time.

Balancing area co-ordination would result in fewer reserves being required. Furthermore, combining geographical areas would also tend to reduce overall forecasting errors and ramping requirements (Figure 3.5).

Appropriate operation of an interconnector can provide the system with greater flexibility by allowing for a more efficient use of flexibility resources than would otherwise have been possible (IEA, 2011). In addition, interconnection can provide frequency response, and interconnection via AC transmission lines can also contribute to the sharing of inertia between systems.

Co-ordination between balancing areas effectively requires inter-regional planning between different jurisdictions. This can also be a platform for achieving market integration, as discussed in the later section on integrated planning with VRE.

These activities are being pursued in a number of European markets. Recent developments include the International Grid Control Co-operation (IGCC) platform. The IGCC is a regional project operating an imbalance netting process. It currently involves 11 TSOs from 8 countries, consisting of Austria, Belgium, the Czech Republic, France, Germany, the Netherlands, Sweden and Switzerland (ENTSO-E, 2017c).

The Nord Pool is also a good example of interconnection management and co-ordination across balancing areas (Box 3.5). Cross-border interconnectors between Denmark, Norway, Sweden and Germany, via both AC and DC links, have allowed wind power output to be transported to other countries and also help to spread variability to a larger balancing area.

Figure 3.5 • Benefits of combined balancing area operations

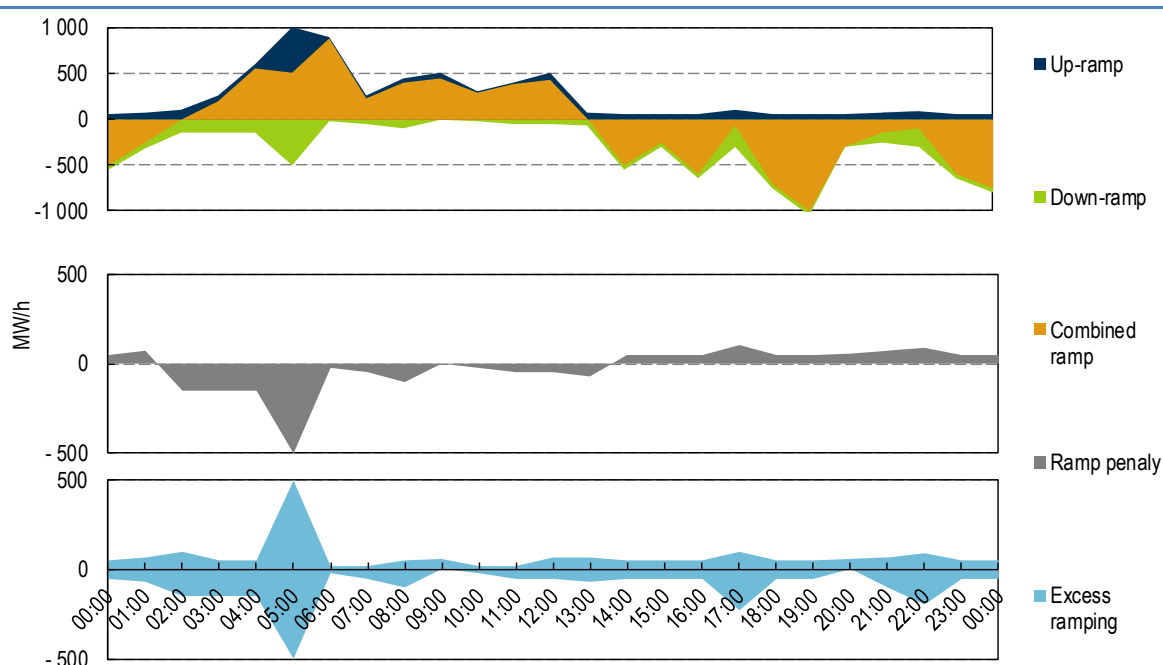

Note: MW/hr = megawatts per hour.

Source: NREL (2007), *Impact of Balancing Areas Size, Obligation Sharing, and Ramping Capability on Wind Integration*.

Key point • Combining balancing area operations reduces ramping requirements.

Box 3.5 • Nordic market interconnection management

The Nord Pool Spot (NPS) market is an example of good practice for interconnection management. Auctions of the transmission capacity connecting the 12 Nordic market zones to the Central and Western European (CWE) markets are implicit in the day-ahead market for electricity.

The NPS market covers the Nordic region, ensuring that a deep pool of flexibility is available. A suite of markets exists (day-ahead, intraday and real-time operational reserves), enabling trade across interconnectors from day-ahead right up to the delivery hour. It is also used for real-time balancing, where the four SOs collaborate in balancing the whole system instead of any single country, using their pooled resources.

Interconnections in Denmark are already used to balance the system, selling energy when wind production is high and importing energy when wind production is low (Figure 3.6).

Interconnectors are also used for maintaining system stability in Denmark; roughly 80% of the variation in wind power during 2014 was compensated by commercially driven exchanges through interconnectors

Source: ENS (2015), *Flexibility in the Power System – Danish and European Experiences*.

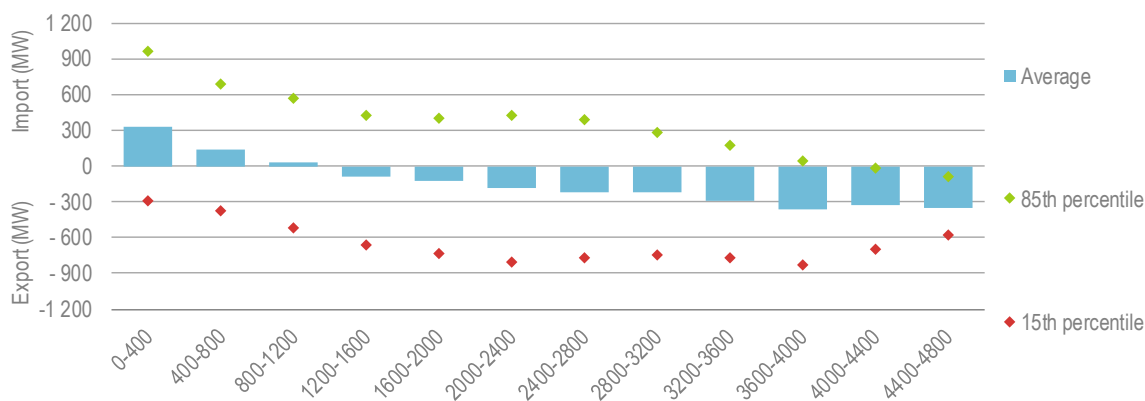
Figure 3.6 • Interconnector flows and wind generation in Denmark

Source: Energinet.dk (2017), *Market Data*, www.energinet.dk/EN/EI/Engrosmarked/Udtraek-af-markedsdata/Sider/default.aspx.

Key point • A larger balancing area can maximise the value of VRE generation.

The need for operational requirements relevant to VRE plants

The role of grid codes and VRE plants

To ensure proper co-ordination of all components in the power system, a set of rules and specifications needs to be developed and adhered to by all stakeholders in the power sector. This set of rules is referred to as a grid code. Grid codes cover many aspects, including connection codes, operating codes, planning codes and market codes (IRENA, 2016).¹¹

Grid codes are particularly relevant for wind and solar PV plants because they are technically very different from traditional generators. During the initial phases of VRE, its impact on the system is minimal and its influence on grid stability could easily be managed. Therefore, 20 years ago in

¹¹ Planning codes contain rules on planning the expansion of the grid and new generation capacity. Market codes contain rules for the trade of electricity and how to incorporate technical restrictions in the formation of prices.

early adopter markets, the need for VRE plants to provide grid support services was not recognised.

As the share of VRE displacing conventional generation increases, so the need grows for VRE to contribute to providing grid support services, such as frequency regulation and active power control, reactive power and voltage control, and operating reserves. As a result, more stringent and precise technical requirements are required from VRE plants connected to the grid.

VRE plants cannot directly provide frequency regulation services and respond to system disturbances in the same way as traditional power plants. The behaviour of VRE power plants is largely dictated by control settings, originally set according to the manufacturer’s design. However, the settings can be reprogrammed to suit specific requirements of the system.

Technical requirements are prioritised according to the level of VRE deployment

The technical requirements for VRE plants are influenced by the phase of VRE deployment. The main technical requirements relevant to VRE include communication systems, power quality, voltage and frequency ranges of operation, frequency and voltage control, forecasting tools, fault ride-through (FRT) and IBFFR requirements (Table 3.3) (IEA, 2017).

Table 3.3 • Incremental technical requirements for different phases of VRE deployment

	Always	Phase 1	Phase 2	Phase 3	Phase 4
Technical requirements	<ul style="list-style-type: none"> - power quality - frequency and voltage ranges of operation - visibility and control of large generators - communication systems for large generators 	<ul style="list-style-type: none"> - output reduction during high frequency events - voltage control - FRT capability for large units 	<ul style="list-style-type: none"> - FRT capability for smaller (distributed) units - communication systems - VRE forecasting tools 	<ul style="list-style-type: none"> - frequency / active power control - reduced output operation mode for reserve provision 	<ul style="list-style-type: none"> - integration of general frequency and voltage control scheme - inertia-based fast frequency response - stand-alone frequency and voltage control

Grid codes are continuously revised to suit the evolving needs of the power system as the share of VRE increases. In addition, the SO’s growing body of experience with implementation will indicate required changes. The frequency of grid code revision depends on how fast the power system and the energy sector are evolving.

More recently, a number of countries have undergone grid code revisions in response to increasing shares of VRE. These include Germany, Ireland, Spain and Denmark. Ireland has been active in revising their grid code due to the high share of wind (Box 3.6).

One of the most recent developments is in the European Union, where European Commission Regulation 2016/631 has established a network code on requirements for grid connection of generators. Given that it is difficult to predict the amount of a particular system service that will be required as the share of VRE increases, prolonging the process of implementing necessary technical requirements can increase the level of risk to system reliability. In the NEM, for example, technical requirements had not been updated for many years, until recently, to take into account the high share of VRE generation in the system. This contributed to security issues, as discussed in the Australia case study.

Box 3.6 • Ireland's grid code

Ireland has continuously updated its grid code to ensure that the grid can accommodate a large share of VRE generation. A number of modifications to technical requirements have been made to provide support to the power system. These were determined based on extensive studies carried out by the SO, Eirgrid.

The current grid code, Version 6.0, contains a number of technical requirements that have been established specifically for wind farms, addressing active power control, frequency response and voltage regulation. Notable requirements include:

- provide wind turbine generator dynamic models for plants with capacity greater than 5 MW
- retain FRT capability, which requires wind farms to remain connected in the case of voltage dips to 15% of the nominal value that are no longer than 625 milliseconds; in addition wind farms must provide active power and reactive current to help recover the voltage
- retain capability to withstand RoCoF values up to and including 0.5 Hz per second
- remain connected at frequencies within the range 47.0 Hz to 47.5 Hz for a duration of 20 seconds
- respond to frequency deviations in the timescale between 5 and 15 seconds
- control the ramp rate of the active power output over a range of 1% to 100% of capacity per minute.

Source: EirGrid (2015), *EirGrid Grid Code Version 6.0*.

Integrated planning with higher deployment of VRE

To facilitate the integration of VRE, it is also important that issues associated with VRE are taken into consideration in long-term energy planning. This allows appropriate investment decisions to be made on flexible resources in respect of both generation and grid infrastructure. In addition, planning should accurately reflect options for advanced demand response, storage and other relevant trends, such as electrification of transport. Greater system flexibility not only facilitates VRE integration, but also provides other benefits by allowing the system to be operated in a more cost-effective and reliable manner.

Power sector planning is an inherently complex process due to the long planning horizon, and is subject to a range of drivers that are highly uncertain. Further complexity results from planning, consisting of a number of activities that are undertaken by multiple groups and jurisdictions for a given power system (Cochran et al., 2012).

Traditionally, the primary focus of power sector planning was on expanding supply infrastructure (generation, transmission and distribution networks) to meet projected electricity demand, based on assumptions of economic growth over the next 20 to 30 years. However, with the changing landscape of the power sector, due to increasing deployment of VRE and other new technologies, as well as increasing consumer participation, planning for a future power system needs to become more sophisticated by taking account the role and impact of these developments.

Better integrated and co-ordinated planning frameworks can help identify appropriate options for future power systems. The process should take into account questions of flexibility and reliability, and how different supply- and demand-side resources can play a role in successful integration of VRE, providing a pathway for power system transformation.

Integrated planning is being adopted in a number of jurisdictions, taking into account a range of drivers to effectively accommodate developments in the power sector, particularly with respect to VRE deployment (Miller et al., 2015).

Co-ordinated and integrated planning encompasses a number of elements, which can be broadly grouped into the following:

- integrated planning incorporating demand resources
- integrated generation, transmission and distribution planning
- cross-sectoral planning between electricity sectors and other sectors, particularly heating and cooling and transport sectors
- planning across different regions, jurisdictions and balancing areas.

Integrated planning incorporating demand resources

This aspect of integrated planning relates to a planning process that takes into account demand resources.

The potential role of the demand side is often overlooked in power sector planning. Demand response can be provided through distributed energy resources (DER), which are typically modular and/or small in scale, connected to a local network, with the capability to provide energy or system services. DER include distributed generation, flexible demand, storage and other resources.

Appropriate demand response can achieve various benefits, including smoothing the variability of VRE and maintaining system reliability by providing fast response services. It can also play a major role in deferring or avoiding investment in generation and networks. DSM options encompass a number of possible interventions, from energy reduction programmes to active load management (IEA, 2014).

Co-ordinated planning across supply and demand resources can take into consideration the locational value of energy, which helps identify the most advantageous areas for the development of VRE technologies.

Box 3.7 • PacificCorp's Integrated Resource Plan

PacificCorp, a utility operating across six states in the Northwest of the United States, has integrated energy efficiency and dispatchable demand-response programmes into electricity planning, under its Integrated Resource Plan (IRP). They are assessed as a supply resource, allowing them to be compared with other supply options in the IRP model.

This has led to cost-saving energy efficiency measures that accounted for a large proportion of electricity supply in the final IRP.

Source: Wilson, R. and B. Biewald (2013), *Best Practices in Electric Utility Integrated Resource Planning: Examples of State Regulations and Recent Utility Plans*.

Integrated generation and network planning

The integrated planning approach optimises resources across an entire network, resulting in a number of benefits from reliability, economic and environmental perspectives. Historically, power system planning, as carried out by vertically integrated regulated monopolies, was typically well co-ordinated, resulting in low levels of congestion.

Page | 52

In jurisdictions with a restructured market, however, co-ordinated planning is typically more difficult (IEA, 2016b). This is often due to generation, transmission and distribution planning being conducted independently in separate processes, since they are managed by different electric utilities. As a result, expansion in generation, transmission and distribution is less likely to align, possibly resulting in ineffective outcomes.

This issue is magnified as the level of VRE deployment increases, since development of VRE projects often outpace changes in other elements of the power system. Geographic concentrations of VRE in areas with the highest-quality resource can place a burden on the local transmission grid and lead to transmission congestion, which ultimately drives up the cost of delivered electricity.

The issue is relevant for both for the transmission and distribution networks, where the addition of new VRE may change traditional energy flows and the use of the grid, and connections at local grids may challenge the usual distribution operations. A VRE project can be developed relatively quickly compared to the development of grid infrastructure. This was the case in Brazil, where 300 MW of wind generation capacity was unable to connect to the grid at the end of 2015 due to limited transmission capacity (Epoca, 2016).

An example of a planning approach that considers generation and transmission expansion is the Renewable Energy Development Zones (REDZ) initiative in South Africa. Eight REDZ were identified based on integrated spatial analysis and stakeholder consultation. The analysis takes into account energy resource potential, infrastructure availability, stakeholder and local authority support, environmental suitability and socio-economic need (SA DOE, 2015). The location of the REDZ further serves to inform grid planning, identifying and confirming the areas where grid capacity will be required to support the targeted development zones. Details of REDZ are shown in the South Africa case study in Chapter 6.

In addition to integrated planning, procurement strategies can provide financial incentives based on the location of VRE plants. This is discussed in Chapter 4 on grid investments.

Integrated planning between the power sector and other sectors

Integrated planning that spans the power and other sectors is a growing field in energy system integration. Historically, planning across different sectors was thought to be relevant only for the electricity and gas sectors, since gas is one of the main fuels for electricity generation in many countries. However, even power and gas planning has been carried out separately in many countries due to a number of challenges, particularly from institutional and regulatory perspectives.

Efforts have been made in many jurisdictions to link the planning of electricity and gas. In the European Union, the European Commission has encouraged electricity planners to work with gas partners in ENTSO-G (European Network of Transmission System Operators for Gas) to create a common baseline of assumptions. This involves using the same analytical basis for their respective ten-year network development plans. These plans would then be used as the basis for the cost-benefit analysis of different electricity and gas network expansion or reinforcement projects.

More recently, continuing innovation in and uptake of demand-side technologies are having an impact on the power system. Demand-side technologies, particularly electric vehicles (EVs), have the potential to facilitate a high share of VRE in the power system. Such technology options can be deployed in a way that increases the flexibility of the system. For example, EVs with smart charging can be used to provide flexibility and facilitate VRE integration by charging during periods of high VRE output and supplying to the grid when output declines.

In addition, linking the power and transport sectors can also support development and planning of EV charging infrastructure, enabling greater uptake of EVs. As EV uptake grows, increasing interaction between power and transport sectors can be seen. A number of jurisdictions have incorporated cross-sectoral links between planning in the power sector and the transport sector, including Scotland, Japan and the United States (Miller et al., 2015). In Scotland, EVs have contributed to wind integration by absorbing excess wind generation, which prevents curtailment (Miller et al., 2015).

Inter-regional planning

Power system planning was traditionally confined to established single-utility balancing areas. However, with an increasing share of VRE deployment, expanding the size of balancing areas can potentially provide greater flexibility through resource diversification across different geographical regions. In addition, greater geographic diversification of generation sources will lead to less variability in supply. Large and integrated power systems also tend to be more secure, albeit more complex from the perspective of system operation.

Changes to balancing areas and greater amounts of inter-regional planning have emerged over time from subtle moves toward electricity market integration in certain jurisdictions (Miller et al., 2015). Planning that expands across balancing areas or national jurisdictions can lead to more efficient use of existing generation and transmission resources and minimise the costs of expansion.

Many neighbouring TSOs have now started to co-ordinate power system planning in order to optimise the use of resources and benefit from increased flexibility. Inter-regional co-ordination is evident in the European Union, South Asia, Association of South East Asian Nations (ASEAN) and the United States (IEA, 2015; IEA, 2016b).

Since 2011, regional transmission planners in the United States have been required to develop regional plans and co-ordinate with their neighbouring transmission planners (FERC, 2016). In South Asia, the power systems of India, Bhutan and Nepal have been interconnected and synchronised since 2013. In 2014, governments signed the South Asian Association for Regional Cooperation (SAARC) framework agreement on energy co-operation, one element of the energy pillar being the development of an inter-regional electricity market and the further development of interconnections (SAARC, 2017).

Despite the potential benefits of inter-regional planning, a number of challenges are associated with the institutional and contractual arrangements for multilateral trade. Such cross-border arrangements can be complex and difficult to achieve.

The European Union is a prominent example of regional co-ordination in transmission planning. ENTSO-E (European Network of Transmission System Operators for Electricity) was created to co-ordinate transmission network planning and operation across different jurisdictions (IEA, 2016c). This includes drafting network codes, co-ordination and monitoring of network code implementation and development of long-term regional network plans (Box 3.8).

Box 3.8 • Co-ordinated transmission network planning in Europe

ENTSO-E publishes an updated Ten-Year Network Development Plan (TYNDP) every 2 years to give an overview of the transmission expansion plans in the next 10-15 years that have been identified as necessary to facilitate EU energy policy goals. The TYNDP is a co-ordinated planning initiative to deliver a pan-European transmission plan within the ENTSO-E region. It is the outcome of a two-year process, starting with the development of scenarios or visions of how the European power system might look in 2030.

The TYNDP 2016 analyses the required transmission and interconnector developments under different scenarios, termed “Visions”, with renewables penetration levels of between 45% and 60% in 2030. It pinpoints about 100 spots on the European grid where bottlenecks exist or may develop if reinforcement solutions are not implemented.

The projects that have been identified in the TYNDP will contribute towards meeting EU energy policy goals. Based on the goals, Projects of Common Interest (PCIs) are selected and will benefit from accelerated licensing procedures, improved regulatory conditions, and some access to financial support.

Source: ENTSO-E (2016), *Ten-Year Network Development Plan 2016*.

Planning and operation of low- and medium-voltage grids in light of increased DER

Planning for low- and medium-voltage voltage grids has historically required consideration of load growth for the area served, as well as scenario planning for specific technologies that may become prevalent or significant within the planning horizon. Infrastructure upgrades to the distribution systems are generally a major investment, amortised over multiple decades, and require considerable time and/or project staging to complete, so long-term planning is undertaken to manage future investments. The planning horizon for distribution infrastructure is typically 5 to 10 years.

New planning requirements

When considerable amounts of DERs, such as VRE, are expected to be integrated into local grids within the planning horizon of a distribution utility, additional and potentially more complicated planning studies typically need to be completed. This is to ensure the continued safe, reliable and cost-effective operation of the interconnected distribution system (IEA PVPS, 2014). Depending on local circumstances, SOs are likely to pursue a combination of additional planning activities (Table 3.4).

Table 3.4 • Additional planning activities to integrate DER

Study topic	Purpose
Gross load estimation	Determine circuit load masked by DER generation
Circuit reconfiguration	Ensure that reconfiguration remains possible with DER integration
Power flow	Identify potentially overloaded and/or unidirectional components that may experience reverse power flow
Voltage regulation	Ensure voltage power quality and inform placement and control setting for automatic voltage regulation equipment

Source: Seguin et al. (2016), *High-Penetration PV Integration Handbook for Distribution Engineers*.

Improved screening/study techniques

Local utilities use “screens”¹² to assess the impact that DER, such as behind-the-meter solar PV projects, will have on the local network. Screening forms part of distribution planning activities and guides the approval process for DER projects.

The precise distribution of DER on a distribution circuit (e.g. near the start of the circuit or near the end of the line) can strongly determine their impact on the circuit. More accurate grid planning can inform SOs about which connection requests merit more in-depth analysis, which ones can be approved without further study, and which projects cannot be connected within the immediate planning horizon without significant circuit modification or upgrade (Box 3.9).

Many of the grid “screens” in place today were designed in a context of low DER penetration. To improve the accuracy of local grid screening, planning efforts must include future scenarios for DER penetration at a relatively high spatial resolution, such as neighbourhood or even street level. Planning tools could use socio-economic data to determine the likelihood of DER adoption in certain areas (Sigrin et al., 2016). An alternative approach to grid impact assessment assumes random placement of DER (Smith and Rylander, 2012). As such, improved screens require considerable development to account for the rising complexity of the required analysis at high penetration (Rylander et al., 2015).

Box 3.9 • Beyond 15% penetration: New technical DER interconnection screens for California

In the past, DER projects in California required a full interconnection study if aggregate DER capacity amounted to 15% of the peak load of the circuit. With the growth of PV deployment, this limit was reached more often, leading to burdensome administrative processes, which slowed down further deployment. Today, a more refined analysis is performed to determine which DER projects are more likely to saturate local circuits, and require in-depth analysis by the utility. This has made project assessment less burdensome and more effective, saving time and money for the utility and project developers alike.

After screening, SOs can apply quasi-static time-series (QSTS) analysis, or alternative study methods to assess PV interconnection requests (NREL, 2014). QSTS analysis incorporates more precise load and solar irradiance models, and allows for a more refined understanding of the expected impacts of DER on combined circuit operation and voltage regulation equipment. However, even with modern-day consumer-grade computing equipment, a comprehensive assessment can take several days to complete. Less time-intensive study methods and tools are needed to enable VRE interconnection. The German local SO, EWE Netz, is leading efforts to reduce this delay, so that project developers or home owners can receive the outcome of the screening exercise in as little as a few minutes.

Advanced data-driven local system management

Aside from offering a range of useful energy services, DER and enabling technologies are sources of valuable data that can inform grid operations and planning. DER can inform the operator about the state of the system, either directly or enabled by an energy management system (EMS) or a third-party aggregator (NREL, 2016).

With improved communication via standard internet links or other systems, SOs gain visibility about the location of DER and their provision of energy and energy services in real time. It also

¹² A “screen” is a visualisation used by the local system operator to determine thermal and voltage capacity limits of the local network.

becomes possible to forecast production and consumption levels by DER on the basis of meteorological conditions.

Advanced distribution management systems (ADMS) need to be put in place to provide adequate control to SOs. ADMS manage and organise data flows on the side of the operator. A key feature of ADMS is that they enable the communication of set points and other control signals to the end customer. This allows for the dispatch of real and reactive power embedded in a portfolio of end users, as well as equitable curtailment when the need arises.

References

- AEMO (2014), *Independent Planning Review: Attachment A – Transgrid Project Assessment Reports*, Australian Energy Market Operator.
- Aivaliotis, S. (2010), *Dynamic Line Ratings for Optimal and Reliable Power Flow: Enhanced Power Flow for the Smart Grid*, FERC Technical Conference, www.ferc.gov/CalendarFiles/20100623162026-Aivaliotis,%20The%20Valley%20Group%206-24-10.pdf.
- Cochran, J., D. Lew and N. Kumar (2013), *Flexible coal: Evolution from baseload to peaking plant*, 21st Century Power Partnership.
- Cochran, J. et al. (2012), *Integrating Variable Renewable Energy in Electric Power Markets: Best Practices from International Experience*, National Renewable Energy Laboratory, Golden.
- De Boeck, S. et al. (2016), “Review of defence plans in Europe: Current status, strengths and opportunities”, *CIGRE Science and Engineering*, No. 5, June 2016.
- DGA Consulting (2016), *International Review of Frequency Control Adaptation: A Report to the Australian Energy Market Operator (AEMO)*, DGA Consulting.
- EirGrid (2015), *EirGrid Grid Code Version 6.0*, EirGrid, www.eirgridgroup.com/site-files/library/EirGrid/GridCodeVersion6.pdf.
- Energinet.dk (2017), *Market Data*, Energinet.dk, www.energinet.dk/EN/El/Engrosmarked/Udtraek-af-markedsdata/Sider/default.aspx.
- ENS (2015), *Flexibility in the Power System – Danish and European Experiences*, Danish Energy Agency, Copenhagen.
- ENTSO-E (European Network of Transmission System Operators for Electricity) (2017a), *Actual Generation per Production Type* (database), <https://transparency.entsoe.eu/generation/r2/actualGenerationPerProductionType> (accessed 14 April 2017).
- ENTSO-E (2017b), *ENTSO-E Network Codes*, ENTSO-E.
- ENTSO-E (2017c), *Imbalance Netting*, ENTSO-E, www.entsoe.eu/major-projects/network-code-implementation/electricity-balancing/igcc/Pages/default.aspx.
- ENTSO-E (2016), *Ten-Year Network Development Plan 2016*, ENTSO-E, <http://tyndp.entsoe.eu/>.
- Epoca (2016), “A força dos ventos” [The force of the winds], Epoca Negócios website, <http://epocanegocios.globo.com/Caminhos-para-o-futuro/Energia/noticia/2015/08/forcados-ventos.html> (accessed April 2017).

- FERC (2016), Order No. 1000 - Transmission Planning and Cost Allocation, Federal Energy Regulatory Commission, Washington, DC, www.ferc.gov/industries/electric/indus-act/trans-plan.asp.
- Henderson, C. (2014), *Increasing the Flexibility of Coal-Fired Power Plants*, IEA Clean Coal Centre, London.
- Hirth, L. and S. Mueller (2016), "System-friendly wind power: how advanced wind turbine design can increase the economic value of electricity generated through wind power", *Energy Economics*, Vol. 56, Elsevier, pp. 51-63.
- Holdman, J. (2016), "Coal Creek to fluctuate power output", *Bismarck Tribune*, 26 December, http://bismarcktribune.com/business/local/coal-creek-to-fluctuate-power-output/article_de8433c4-ec52-528d-8ab8-e55d2d45e845.html.
- Holman, J. (2011), *Increasing Transmission Capacity*, Wind System magazine.
- IEA (2017), *Getting Wind and Sun onto the Grid: A Manual for Policy Makers*, OECD/IEA, Paris.
- IEA (2016a), *Medium-Term Renewable Energy Market Report 2016*, OECD/IEA, Paris.
- IEA (2016b), *Re-powering Markets: Market Design and Regulation During the Transition to Low-Carbon Power Systems*, OECD/IEA, Paris.
- IEA (2016c), *Electricity Security Across Borders: Case Studies on Cross-Border Electricity Security in Europe*, OECD/IEA, Paris.
- IEA (2015), *Development Prospects of the ASEAN Power Sector*, OECD/IEA, Paris.
- IEA (2014), *The Power of Transformation: Wind, Sun and the Economics of Flexible Power Systems*, OECD/IEA, Paris.
- IEA (2011), *Harnessing Variable Renewables: A Guide to the Balancing Challenge*, OECD/IEA, Paris.
- IEA RETD (2015), *Integration of Variable Renewables*, IEA Renewable Energy Technology Deployment, Brighton.
- IEA PVPS (2014), *High Penetrations of PV in Local Distribution Grids*, International Energy Agency Photovoltaic Power Systems (PVPS) Programme, OECD/IEA, Paris.
- IRENA (2016), *Scaling Up Variable Renewable Power: The Role of Grid Codes*, International Renewable Energy Agency.
- Madjarov, K. and J. Chang (2012), "How are markets adjusting to large amounts of renewable generation?", *8th Annual Carnegie Mellon Conference of the Electricity Industry*.
- Martinot, E. (2015), "How is Germany integrating and balancing renewable energy today?" (educational article), January, www.martinot.info/renewables2050/how-is-germany-integrating-and-balancing-renewable-energy-today.
- Miller, M. et al. (2015), *Status Report on Power System Transformation*, 21st Century Power Partnership (CPP).
- Miller, M. et al. (2013), *Next Generation of RES-E Policy Instruments*, IEA Renewable Energy Technology Deployment, Brighton.
- Milligan, M., P. Denholm and M. O'Malley (2012), *Stochastic Methods for Planning and Operating Power Systems with Large Amounts of Wind and Solar Power*, National Renewable Energy Laboratory, Golden.

NREL (2016), *Feeder Voltage Regulation with High-Penetration PV Using Advanced Inverters and a Distribution Management System*, National Renewable Energy Laboratory, Golden.

NREL (2014), "Methods for performing high penetration PV studies", in *NREL/SCE High Penetration PV Integration Project: FY13 Annual Report*, National Renewable Energy Laboratory, Golden.

NREL (2007), *Impact of Balancing Areas Size Obligation Sharing, and Ramping Capability on Wind Integration*, National Renewable Energy Laboratory.

Rylander, M. et al. (2015), *Alternatives to the 15% Rule: Final Project Summary* (report), Electric Power Research Institute (EPRI).

SAARC (2017), *Area of Cooperation*, South Asian Association for Regional Cooperation, http://saarc-sec.org/areaofcooperation/cat-detail.php?cat_id=55.

SA DOE (2015), *Stage of Renewable Energy in South Africa*, South Africa Department of Energy.

Seguin, R. et al. (2016), *High-Penetration PV Integration Handbook for Distribution Engineers*, National Renewable Energy Laboratory, Denver.

Sigrin, B. et al. (2016), *Distributed Generation Market Demand Model (dGen): Documentation*, National Renewable Energy Laboratory, Golden.

Smith, J. and M. Rylander (2012), *Stochastic Analysis to Determine Feeder Hosting Capacity for Distributed Solar PV*, Electric Power Research Institute (EPRI).

US DOE (2012a), *Dynamic Line Rating Systems for Transmission Lines*, Smart Grid Demonstration Program, US Department of Energy, Washington, DC, www.smartgrid.gov/sites/default/files/doc/files/Global_Smart_Grid_Federation_Report.pdf.

US DOE (2012b), *Economic Dispatch and Technological Change: Report to Congress*, US Department and Energy, Washington, DC.

Wilson, R. and B. Biewald (2013), *Best Practices in Electric Utility Integrated Resource Planning: Examples of State Regulations and Recent Utility Plans*, The Regulatory Assistance Project (RAP) and Synapse Energy Economics.

Chapter 4. Policy, regulatory and market frameworks to support VRE integration

HIGHLIGHTS

- The large-scale uptake of variable renewable energy (VRE) challenges traditional policy, market and regulatory frameworks, regardless of market structure.
- Vertically integrated systems are seeing a push towards mechanisms to improve the efficiency of power system operation, particularly over larger geographical areas.
- In restructured electricity markets, there is a tendency to implement mechanisms to ensure security of electricity supply.
- The main objectives of policy, regulatory and market frameworks are: efficient operation of the power system at growing shares of variable and distributed energy resources; ensuring sufficient remuneration for all providers of grid services; ensuring sufficient investment in clean power generation; pricing of negative externalities; unlocking flexibility from all existing resources; ensuring security of electricity supply; and achieving the integration and development of new flexibility.

In the context of power system transformation, the large-scale uptake of VRE challenges traditional policy, market and regulatory frameworks. This is true for all market structures, irrespective of whether they lean towards a fully restructured, liberalised model or towards the vertically integrated model. However, the required adaptations will be quite different in each circumstance, reflecting different starting points. What can be observed globally is a degree of convergence between the different models.

Policy, market and regulatory frameworks for efficient operation of the power system

Policy, market and regulatory frameworks have a strong bearing on the way in which decisions relating to power system operations are made. Where wholesale markets are in place, operational decisions are based on the bids made by generators, but such markets differ in their precise design (see below). Recent years have seen growing interest in the establishment or strengthening of such markets to improve the operational efficiency of the power system and better incorporate higher shares of VRE. The drivers behind this include the potential for savings from making better use of existing assets, in particular across large geographical regions. In addition, the introduction of wind and solar power has emerged as a driver for improvements in market design. It is important to note that well-designed short-term markets are not only relevant for co-ordinating operational decisions; they can also contribute to improving the investment environment for new generation, incentivise flexibility and provide accurate information for the retirement of plants. Consequently, introducing or improving short-term markets should be a first priority.

Least-cost dispatch - the role of short-term markets (minutes to hours)

Short-term markets are the foundation of all market-based electricity systems and have been proven to be a valid approach to cost-effective integration of high shares of VRE. In most cases, they consist of two main markets: the day-ahead market and the real-time market (Figure 4.1). In the day-ahead market, participants bid for energy and the market clears and sets hourly prices

for each hour of the next day. Generating units are committed accordingly. Then, during the day, adjustments have to be made to balance supply and demand, which are continuously updated. This is done either by system operators or by generators. In Europe, participants can also exchange electricity blocks on an intraday market platform before system operators set balancing energy prices that clear the balancing (or real-time) market. In North America, system operators calculate real-time prices in a five-minute market. System operators also procure a number of ancillary services, including operating reserves, to instantaneously restore frequency.

In addition to these short-term markets, medium- and long-term markets enable trading of electricity and forward capacity development, in advance of the day-ahead timeframe. While they play a key role in investment decisions (see following sections), it should be remembered that the underlying product of all these markets is the energy traded on short-term markets.

There is no standard design for electricity markets. Broadly, however, existing short-term markets fall into two categories depending on the degree of geographical and temporal resolution of electricity prices (IEA, 2016):

- **Low-resolution** market designs have been implemented in Europe, where the primary objective was to enable cross-border trade in electricity. Each country had relatively little internal network congestion and a single price by country was considered sufficient. Within each price zone, power exchanges, not system operators, calculate prices as if congestion and network constraints did not exist. System operators handle congestion by redispatching power plants. The primary market is the day-ahead market. Participation is not mandatory.

The balancing/real-time market is a residual market designed to give market participants the incentive to balance generation and load rather than to reflect the marginal cost of the system.

- **High-resolution** market designs seek to provide an accurate economic representation of the physical reality and operation of power systems. These have become more common in parts of the North America, for example in Texas (Alaywan, Wu and Papalexopoulos, 2004). To that end, system operators directly manage the market platform using sophisticated software to perform security-constrained economic dispatch (SCED).

The primary market is the real-time market. System operators calculate the locational marginal price for thousands of nodes in order to reflect real-time congestion on the network (Schweppe et al., 1988; Hogan, 1992 and 1999). In order to better reflect economically (in prices) the flexibility needed to accommodate renewables, the time resolution has recently been increased to five minutes in several markets. Day-ahead market prices reflect the best forecast of real-time electricity prices.

High-resolution market design constitutes the benchmark for short-term markets and can reduce overall costs of operating power markets (Green, 2007; Neuhoff and Boyd, 2011). Market design with a high geographic and temporal resolution is better suited to integrating increasing shares of VRE. Existing high-resolution market designs can be further improved if they become more transparent during the intraday time frame, to facilitate the adjustment of power schedules to improving wind and solar forecasts.

Conversely, the geographical resolution of low-resolution markets has to be improved to contribute to the efficient operation of a more diverse set of power plants. However, the contrast between high- and low-resolution market designs reflects the difference in information provided to the market about local and general scarcities in the system. Indeed, the laws of physics are the same everywhere, and even in low-resolution designs, system operators use centralised market platforms with location-specific information to manage congestion and call the power plants needed to balance generation and load in real time. Increasing the

transparency of short-term balancing prices by location will become more important with high shares of renewables and would ensure a convergence of market designs (IEA, 2016).

Figure 4.1 • Overview of the different building blocks of electricity markets

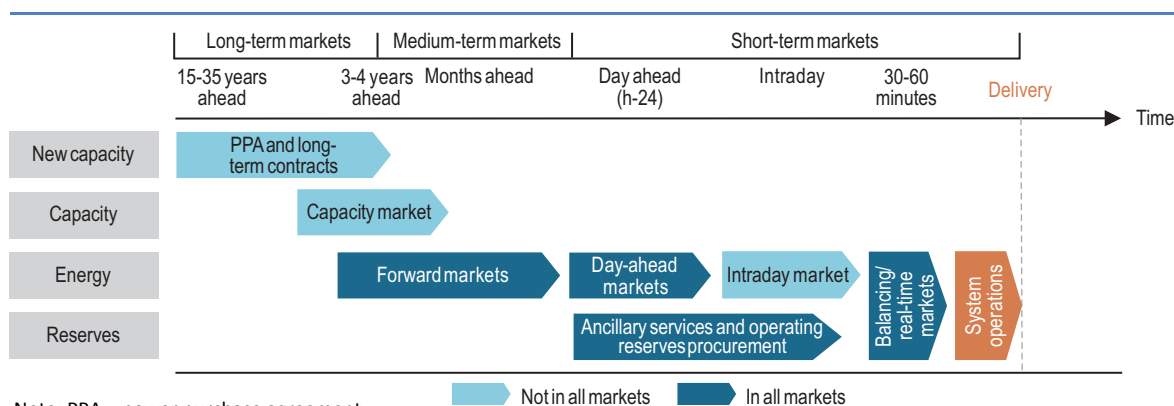

Note: PPA = power purchase agreement.

Source: Reprinted from IEA (2016), *Re-powering Markets: Market Design and Regulation during the Transition to Low-Carbon Power Systems*.

Key point • A suite of interrelated markets is used to match generation and load in different timescales.

Recent improvements to the design of short-term markets have focused primarily on: enabling trading closer to real time, improving pricing during periods of scarcity, reforming markets for procurement of system services, allowing for trade over larger geographical regions, and better incorporating distributed resources. The last point is discussed in greater detail in the topical focus in Chapter 5. The other points will be discussed in turn, alongside selected examples.

Moving operational decisions and trade closer to real time

Technical constraints call for a certain degree of forward planning and scheduling with regard to system operation. In practice, however, many power systems tend to lock in operational decisions far more in advance than technically required, sometimes weeks or even months ahead. For example, long-term contracts between generators and consumers may prevent power plants from providing flexibility. Such a situation is undesirable for least-cost system operation, in particular at high shares of VRE penetration. In regions where the share of VRE is on the rise, steps have been taken to improve the trading arrangements for electricity close to real time.

For example, in Europe a number of steps are being taken to improve the functioning of intraday markets. In Germany, the functioning of these markets has been systematically improved over recent years. As a first step, the German power exchange, Epex Spot, introduced the ability to trade 15-minute and 60-minute blocks of electricity on the intraday market, a higher level of granularity than the 60-minute contracts on the day-ahead market. This has allowed intraday trade to more accurately reflect the ramping up and down of solar PV generation during morning and evening hours. While trading was originally continuous (supply and demand matched as soon as possible), auctions were introduced in 2015 to improve market functioning (supply and demand offers are collected and then matched in groups). As a result, the volumes traded on the intraday market have increased substantially over the past five years (Figure 4.2).

Given that VRE forecasts are more accurate closer to real time, power plant schedules should ideally have the option to be updated accordingly. Otherwise, a power plant that may be technically capable of supplying flexibility may be prevented from doing so due to a binding schedule, which is based on outdated information. Where power plant schedules are determined by trade on a power market, the term “gate closure” refers to how close to real time generation schedules can be changed (without changing the plant-specific bids of market participants).

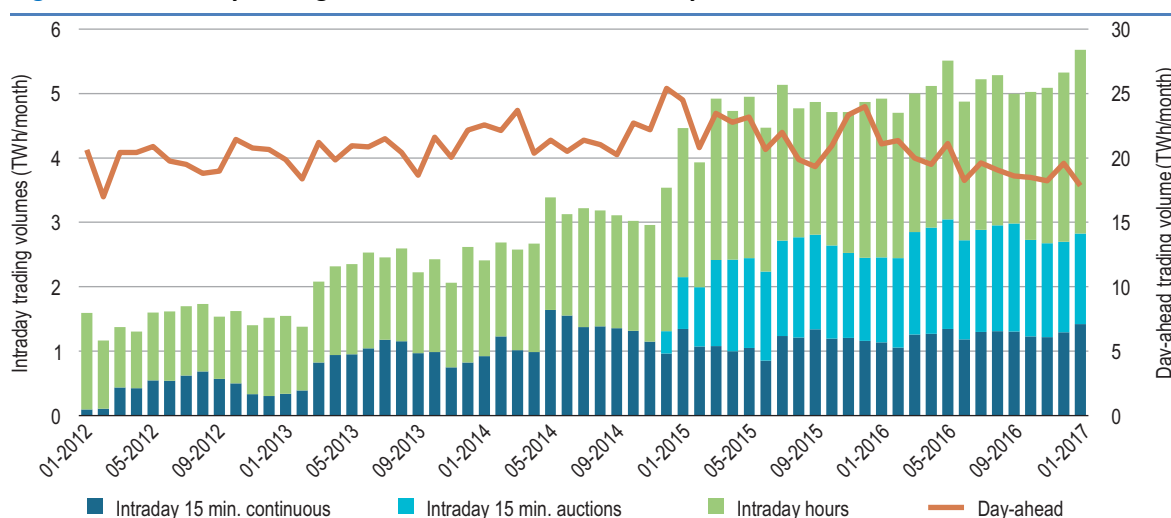
Figure 4.2 • Monthly trading volumes on the German intraday market, 2012-16

Note: TWh = terawatt hour.

Source: 50Hertz Transmission GmbH (2017), "The transmission perspective".

Key point • Germany has systematically developed its intraday market to facilitate trading closer to real time.

In the United States, the Federal Energy Regulatory Commission (FERC) passed a new rule in June 2016 (FERC, 2016a) that aims to improve trading of electricity closer to real time. FERC now requires US independent system operators (ISOs) and regional transmission organisations (RTOs) to settle real-time markets at the same resolution as the dispatch of the system.¹³ Historically, market participants were sometimes only allowed to submit price offers that were valid for a full hour, while the actual adjustment of power plant operations was performed on a five-minute basis. However, this meant that it was not possible to update bids according to new information close to real time. The new ruling removes this mismatch, mandating that the length of the settlement period be the same as the dispatch interval. The same principle is applied to operating reserves. The rule will affect those ISOs that have not already adopted these practices (ISO-NE, MISO and PJM). The rule also targets improved scarcity pricing (see next section).

A similar process is under way in Australia, where the Australian Energy Market Commission is currently considering a rule change to align the National Electricity Market (NEM) settlement period (currently 30 minutes) with its dispatch interval (5 minutes). The rule change was requested in May 2016 and is currently under consideration (AEMC, 2017a). The supporting documentation for the requested rule change – submitted by a large energy consumer – highlights why such an alignment can be desirable:

Generators receive the average price of generation over a full interval. If fast generation is scheduled for one dispatch interval on the basis of a high price bid, it is paid the average dispatch price over the 30 minute trading interval, for the dispatch over the one interval in which it participated. The average price may not be sufficient for investment in fast response generation, or for operation of existing fast response generation. [...]

Likewise, loads pay the average price across the whole trading interval; even if they respond to the price spike to reduce output, they are unable to reduce their output on past dispatch intervals. The overall impact of time weighted 30 minutes pricing, instead of 5 minute actual usages is that the price changes after consumption. (Sun Metals, 2016)

¹³ These are the California ISO (CAISO), ISO New England (ISO-NE), Midcontinent (MISO), New York ISO (NYISO), PJM and Southwest Power Pool (SPP).

Improving the short-term operation of the power system is possible even in a context where the policy, market and regulatory frameworks are not well suited to achieving this by default. For example, the power regulation ancillary service introduced in North-East China in 2014 effectively serves as a mechanism to facilitate trading of electricity on an intraday timeframe. Under the mechanisms, thermal generators offer the capability to adjust their output downwards beyond the usual operating levels at short notice. Adjustments below a certain level receive an additional financial compensation, increasing the incentive to improve their ability to respond to short-term system conditions (Zhang and Du, 2016).

Improving pricing during scarcity/capacity shortage

Markets such as that managed by the Electric Reliability Council of Texas (ERCOT) and the Australian NEM currently rely on high wholesale energy prices during times of scarcity to incentivise new generation capacity. It is worth noting that in 2014 ERCOT introduced operating reserve demand curves as an administrative mechanism to improve wholesale pricing during scarcity, increasing the prices according to an administratively predetermined schedule as the available operating reserve decreases. This curve places an economic value on capacity in cases of capacity shortage, progressively increasing the price up to the value of lost load (USD 9 000 per megawatt hour [MWh]) (Figure 4.3).

This “reliability price adder” ensures that reliability actions taken by ERCOT are actually reflected in reserve and energy prices. (In the absence of this adder, reliability actions would suppress prices). Scarcity prices create the incentive for all market participants to provide capacity when it is most needed by the system, and these high prices are contributing to the recovery of the fixed costs of capacity that is rarely used. This illustrates one form of regulatory intervention to improve scarcity price formation.

Figure 4.3 • Examples of operating reserve demand curves (ORDCs) in the ERCOT region, summer 2017

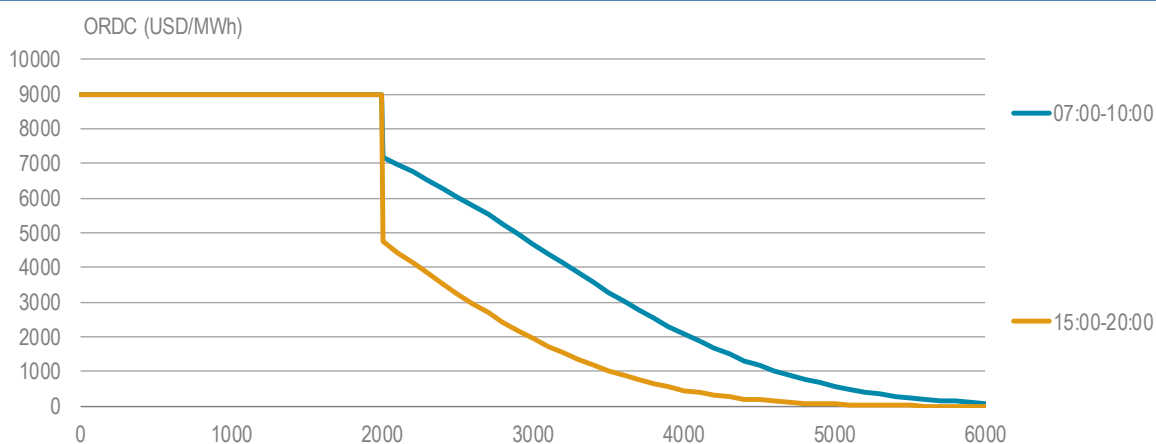

Note: ORDC = operating reserve demand curve.

Source: Adapted from ERCOT (2017), *Real-Time Market*, www.ercot.com/mktinfo/rtm.

Key point • ORDCs can be used to place an economic value on operating reserve in real time.

Scarcity price formation has also been improved in markets that have capacity mechanisms. For instance, PJM is working on the implementation of an operating reserve demand curve (PJM, 2016). Similarly, the Electricity Balancing Significant Code Review in Britain recently introduced reserve scarcity pricing to price short-term reserves into the “cash-out” balancing prices. Other regulators and system operators in Europe (e.g. the Commission for Electricity and Gas Regulation in Belgium and the Finnish TSO) are also considering the possibility of introducing price adders to improve scarcity price formation (B&B, 2016)

Germany provides an example of reform adopting a twin approach, with its recent electricity market reform. A system of strategic reserves has been introduced as a safety net during a transitional period. In the longer run, Germany intends to rely on an energy-only market (market design 2.0) and adjustments are being made to improve scarcity pricing on the wholesale spot market, most notably with the removal of price caps on the-day ahead and intraday markets.

Scarcity pricing and capacity markets can be seen as complementary instruments, with capacity mechanisms providing an additional safety net to meet reliability standards.

Designing capacity mechanisms

Capacity mechanisms supplement energy market revenues with explicit, forward-looking capacity requirements. Auctions are held a few years (typically three or four) ahead of when capacity is expected to be needed, with payments guaranteed for one year, or in some limited cases multiple years.¹⁴ In each of these cases the resource adequacy target – or demand for capacity – is administratively determined.

Such mechanisms aim to provide the incentive for investment in sufficient supply to safeguard resource adequacy. They are prevalent in organised wholesale markets in the United States (ERCOT, an exception, is discussed below), and are becoming more prevalent among competitive markets in Europe (EC, 2016). Forms of capacity mechanism have recently started operations in United Kingdom (2015) and France (2017), and other EU countries (Spain, Ireland and Italy), as well as Japan, are currently implementing or considering such instruments.

While capacity mechanisms are not new, interest in them has surged in certain power systems that have been undergoing transformation in recent years. These systems typically experience a confluence of several factors. First, electricity demand growth is generally sluggish, so that new investments are not needed to balance the market in the short term. Second, there is a push for cleaner generation options, backed by policy mechanisms such as portfolio standards, tax credits, feed-in tariffs or auctions for long-term contracts. Third, existing capacity is ageing, raising concerns over the exit of large amounts of capacity. These conditions are present in parts of Europe, the United States and – most recently – also Australia.

Capacity mechanisms have typically been designed based on the needs of traditional power systems, and the question therefore arises as to whether they are well suited to “transformed” power systems. For example, the traditional metric for resource adequacy is the power system reserve margin (or amount of capacity in excess of expected peak load). For systems with high penetrations of VRE, however, appropriate reserve margins may be difficult to calculate, as the amount of available capacity needed at any given time is dependent on more inherently stochastic processes.

The design of capacity mechanisms also increasingly enables the participation of demand response, and this has proved to be a highly effective solution to kick-start the business of aggregators. These systems may also find that resource adequacy is less of a concern than overall system flexibility. Some have called for capacity mechanisms to be reformed to incentivise investment in more flexible generation (RAP, 2012). Others have expressed concerns that capacity mechanisms may incentivise continued operation of conventional fossil generation and new investment in flexible polluting capacity (such as diesel engines or gas turbines), making it more difficult to decarbonise the power sector (ODI, 2016). This has led to the introduction of emission performance standards in some cases, which could undermine the objective of capacity mechanisms to prevent a shortage of capacity.

¹⁴ Some auctions, such as the capacity market organised by NYISO, operate on a shorter-term time horizon, with payments only guaranteed for the following month.

These criticisms, however, are best addressed by ensuring that capacity mechanisms are designed in such a way as to be technology neutral and to minimise distortions to the wholesale market. To put capacity mechanisms into perspective, in PJM, the capacity component represented 21.9% of the total wholesale electricity price per MWh (Monitoring Analytics, 2017). In France, the first capacity price was EUR 10 per kilowatt (kW) and the regulator estimated that this would represent EUR 1.44/MWh for 2017 (CRE, 2017). It is also clear that, depending on the future progress of demand response and policy maker tolerance for lower levels of reliability, properly designed energy-only markets can also provide the incentive for investment (IEA, 2016).

Reforming mechanisms for the procurement of system services

Reliable operation of the power system critically depends on a number of system services, which contribute to maintaining system frequency and voltage levels. Special capabilities may also be required when restarting the system after a large-scale blackout (so-called black-start capabilities). Different systems may obtain the same service in different ways, for example some will mandate it in the grid code, while others use a procurement or market mechanism.

The reform of system services markets can improve the functioning of the overall market. Indeed, the above examples of using operating reserve demand curves to improve scarcity pricing highlights the link between system services markets, efficient system operation and investment signals.

As the penetration of VRE increases, the need for such services – and hence their economic value – is bound to change. One reason behind this is that conventional generators have traditionally provided many of these services as a simple by-product of power generation. For example, a conventional generator contributes to voltage and frequency stability with its voltage regulator and governor, including the inertia stored in the rotating mass of its turbine and generator. VRE power plants generally have limited capability to provide such services, particularly fast frequency response, which can make it necessary to explicitly procure them.

Higher levels of VRE also increase variability and uncertainty in the supply-demand balance. Hence, it becomes a priority to mobilise higher levels of flexible resources, such as storage and demand response. Reforming system services markets has a critical role to play, alongside other measures (see section on flexibility below).

Ireland and Northern Ireland are committed to increasing the share of renewable energy in electricity generation to 40% by 2020. In this context, to identify possible operational issues in the power system over the coming years, they have established the DS3 work programme (see Box A.3). This programme started a consultation process on a range of new system services products to address and mitigate potential system issues, which had been identified previously by comprehensive technical studies. New products have been proposed to address the challenges associated with frequency control and voltage control in a power system with high levels of variable, non-synchronous generation (Eirgrid/SONI, 2016). The new services identified under the DS3 programme include synchronous inertial response, fast frequency response, fast post-fault active power recovery, and ramping margin. These supplement existing system services products, reflecting new requirements in the specific, Irish context.¹⁵

Similarly, the Australian Energy Market Operator (AEMO) launched the Future Power System Security programme in December 2015 (AEMO, 2017b). Its objective is to adapt AEMO's functions and processes to deliver ongoing power system security and reliability. The programme

¹⁵ The issue of low system inertia and rate of change of frequency (RoCoF) is particularly prominent in Ireland and Great Britain, because RoCoF is used to detect islanding on distribution grids (0.5 hertz per second threshold). The issue of islanding on distribution grids is not the case in many other systems, which are thus likely to face inertia-related issues at a later stage.

targets four high priority areas: frequency control, system strength, management of extreme power system conditions and visibility of the power system. With regard to frequency control, a fast frequency response mechanism is currently under consideration, supplementing existing frequency control ancillary services. One large generator, AGL, also submitted a rule change in September 2016 to establish an ancillary services market for inertia (AEMC, 2017b). These reforms are all ongoing at the time of writing.

A further example of an innovative market product for system services is CAISO's flexible ramping product. It is designed to enable procurement of sufficient ramping flexibility from the conventional generator fleet in order to meet ramping needs that arise from more pronounced changes in the supply-demand balance (CAISO, 2014). Other ancillary services, including frequency response and operating reserves, are already integrated into CAISO's day-ahead and real-time energy markets, with generators bidding into the CAISO ancillary services market, which is co-optimised with energy markets.

In jurisdictions where system services markets have historically received less attention, processes are ongoing to establish standard mechanisms or to begin remunerating services that were traditionally a non-compensated requirement. For example, in India the Power System Operation Corporation Ltd. has released procedures detailing the implementation of a new Reserves Regulation Ancillary Services (POSOCO, 2016). This step marks the introduction of an explicit, financially compensated operating reserves system. In Italy, the Italian Regulatory Authority for Electricity Gas and Water (AEEG) introduced the option of voluntary participation in the primary frequency regulation service in 2014. Previously, this was a purely mandatory, non-compensated service (Terna, 2017).

Exchanging electricity over larger geographical areas

Strengthened integration of markets over large regional areas is important to unlock the benefit of smoothing out the variations and forecast errors associated with VRE and dynamic loads. However, regional integration of power systems is not new. In fact, the development of electricity markets is inseparable from regional integration (IEA, 2014). For instance, the creation of large ISOs/RTOs, such as PJM and MISO in the United States or the NEM in Australia, is aimed at integrating many small balancing areas into one large market. Similarly, in Europe, power markets have largely been designed with the objective of enabling cross-border trade of electricity. The implementation of so-called Market Coupling in 12 countries in 2014 is a major achievement in this regard.

Recent trends have given a new impetus to this development, leading to the establishment of even larger balancing areas. For instance, in the western part of the United States, the Western Energy Imbalance Market (EIM) will enable California and its neighbours to share balancing resource on a regional basis, allowing for more efficient dispatch and reducing the need for new transmission investment. This initiative is relatively advanced compared to other regions, where balancing decisions are generally made at a local level, even when regional interconnections are available.

The Western Interconnect is a large synchronised area that includes 14 US states, two Canadian provinces (Alberta and British Columbia) and the northern portion of Baja California, Mexico. Regional reliability is co-ordinated by the Western Electricity Coordinating Council, but historically balancing responsibilities have remained at the state or local level. CAISO is the region's only ISO, and it operates entirely within the borders of California.

The Western EIM is the first effort to create a regional electricity market in the western portion of the United States. It is unique in two respects. First, unlike the regional wholesale markets in

the Eastern Interconnect (PJM, MISO, etc.) the Western EIM is only a balancing market. Broader responsibility for transmission system operations remains the responsibility of each balancing area. Second, the service territory of the Western EIM is not contiguous (Figure 4.4). Participation in the EIM is voluntary, and utilities may exit at no cost with 180 days' notice. Currently six utilities participate, with three more expected to join over the next few years.

Figure 4.4 • Utilities participating in the EIM

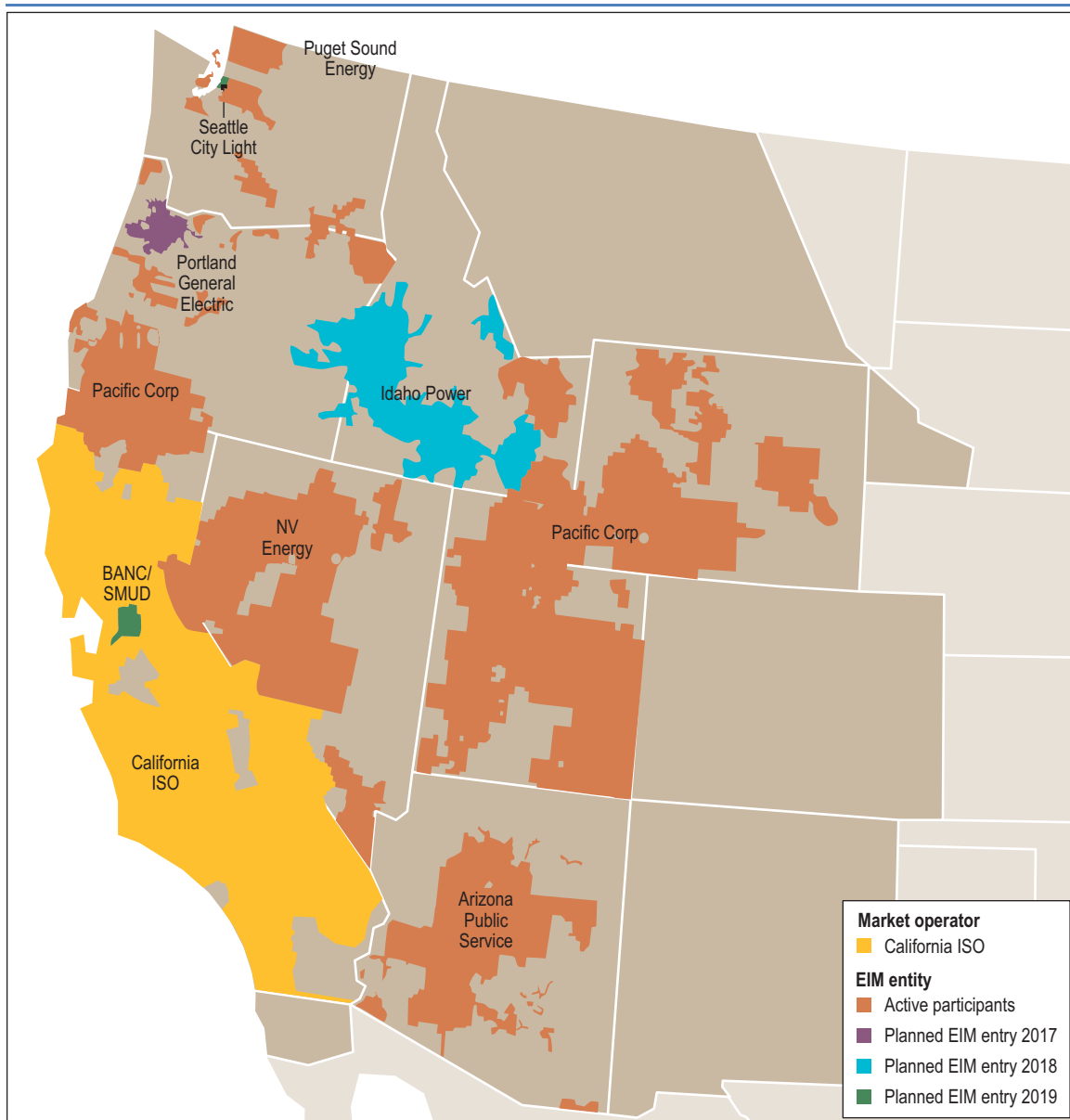

Source: CAISO (2017a), *Western Energy Imbalance Market (EIM)*

Key point • Expanding balancing areas enables different jurisdictions to share balancing resources, allowing for more efficient dispatch and reducing the need for grid investment.

In the absence of a regional entity capable of taking on explicit responsibility for organising the Western EIM, CAISO acts as the market operator. This has led to a somewhat unique governance structure. Although operational responsibility is centralised in CAISO, the Western EIM has its own governing board that includes representatives from participating utilities and regulators from relevant states.

While increased system reliability is often highlighted as a potential benefit of the Western EIM (NREL, 2013), since its implementation the quantification of benefits has focused on economic and environmental impacts. Three benefits are highlighted in particular: more efficient dispatch; reduced curtailment of renewable energy resources; and reduced requirements for flexibility reserves. Estimated benefits for the fourth quarter of 2016 are summarised in Table 4.1.

Table 4.1 • Estimated benefits of the Western EIM, quarter 4, 2016

Benefit	Estimated savings
More efficient inter- and intraregional dispatch	USD 28.27 million
Reduced curtailment of VRE	23 390 MWh
Estimated CO ₂ savings from reduced curtailment	10 011 tonnes
Reduced flexibility reserves	Upward: between 399 MW and 490 MW Downward: between 474 MW and 482 MW

Source: CAISO (2017b), Western EIM Benefits Report Fourth Quarter 2016.

In Europe, progress has been made on integrating the day-ahead electricity markets, but the need remains to better integrate short-term intraday and real-time/balancing markets. The efficiency of markets over large geographical areas requires strong co-ordination and the consolidation of balancing areas.

Efforts to increase market integration and harmonisation across Europe have centred on the development of network codes. The European Union's 2009 legislative package (colloquially known as the "Third Package") mandated, among other things, the development of European Network Codes and Guidelines. These network codes establish a common set of technical and commercial rules for a wide range of topics, including: network security; third-party access; data exchange and settlement; emergency operational procedures; and capacity allocation and congestion management (CACM) for real-time, day-ahead and long-term markets.

Development of the network codes has been managed through an iterative, multi-stakeholder process. The Agency for the Cooperation of Energy Regulators (ACER) is responsible for developing general framework guidelines for each network code, which the European Networks for Transmission System Operators for Electricity (ENTSO-E) then turns into fully developed documents. ACER reviews the network codes, but only the European Commission can approve the final text. Responsibility for implementing the network codes rests with the member states.

This iterative process has been slow and complex, and as a result implementation of some network codes has lagged behind others. Their development has been driven, however, by a set of common concerns, not least of which is the need to more efficiently integrate increasing penetrations of VRE while maintaining system reliability. Implementation of the CACM was in particular seen as a critical piece, as it increases the utilisation of interconnectors and improves overall system flexibility (Hesseling and Hernández, 2015).

More recent proposals by the European Commission to increase regional integration focus on the development of so-called Regional Operating Centres (ROCs). These are an evolution of the existing Regional Security Cooperation Initiatives (RCSIs), voluntary regional collaborative bodies established by the TSOs. The RCSIs do not work in real time, but instead develop system forecasts for their regions based on TSO data. These are the components of a directive proposed as a part of a broader "Clean Energy for all Europeans" package of legislative proposals, presented in November 2016 and currently being discussed at EU level. A final text is expected in 2018.

The evolution toward ROCs is being driven by a requirement of the Third Package for increased regional co-operation. What this means in practice is still under heavy debate. At a minimum, ROCs would perform five services: common grid modelling; analysis of system security;

co-ordination of outage planning; short- and medium-term resource adequacy forecasts; and co-ordinated calculation of transmission capacity (ENTSO-E, 2017). The preferred approach by ENTSO-E, which represents the national TSOs, has been a gradual, “evolutionary” approach. Regional co-operation would be enhanced, but decisions on what additional responsibilities should be borne by the ROCs would be delayed for at least another decade (ENTSO-E, 2016).

Many barriers still stand in the way of regional integration of electricity markets. If the efficiency gains of market integration are important, so are the possibly large distributive impacts. When deciding to invest in new interconnections to achieve better integration of markets, decision makers and regulators have to look beyond the interests of domestic consumers and consider the broader implications for integrated markets. Regional markets require regional governance.

Indeed, even in regions where framework conditions are quite different, closer co-operation can bring value to both sides. For example, despite having very different power market structures, Singapore and Malaysia have been trading electricity on an ongoing basis for years. Singapore has an unbundled, competitive wholesale market environment, while Malaysia has a single-buyer model. The two countries are connected by a single, 450 MW interconnection used for two primary purposes: meeting peak demand, and maintaining overall system stability.

Historically, in the absence of an established method for trading power on an economic basis, power is instead exchanged on a bilateral, rolling net-zero energy exchange basis. That is, exchanges are netted to zero over time to avoid any need for financial compensation.

Ensuring sufficient investment in clean power generation

Investment in new generation capacity requires sufficient long-term visibility of expected revenues. This is true irrespective of the policy, market and regulatory frameworks. In a vertically integrated, regulated monopoly this certainty is provided by the regulator, who allows the monopoly to recover its cost from consumers. In an environment of competitive wholesale markets, forward markets play a critical role in providing sufficient visibility several years ahead. However, large-scale uptake of renewable energy and other low-carbon energy sources can challenge both these approaches.

In the regulated environment, incumbent utilities often face challenges in accessing low-cost capital to shoulder the up-front investment in clean generation options. Indeed, renewable, nuclear and carbon capture and storage power plants all have in common the fact that they incur significant upfront costs. Hence, the cost at which financing can be obtained has a critical impact on overall costs. Resolving this situation is possible by creating a dedicated off-taker that has sufficient financial credibility, and procuring generation capacity via a competitive auction for long-term PPAs.

The challenges in regions with liberalised markets are quite different. These markets are typically already well served with existing capacity (United States, Europe) and in some cases even have surplus capacity. This creates a generally poor environment for new investment. In addition, even where power prices appear attractive in the short- and medium-term, forward visibility may be insufficient to secure financing at a reasonable cost. Hence, in this context long-term mechanisms have also been used to mobilise investment in new, cleaner generation capacity.

It is worth noting that the role of such frameworks in procuring new generation has been shifting in recent years. Rather than covering a large cost gap in relation to fossil sources, their role is now providing revenue certainty to mitigate risk for capital-intensive technologies. In the absence of such measures, the risks are likely to drive up the cost of deployment or hinder it altogether (IEA, 2015).

As the global VRE industry matures, governments and utilities are moving towards competitive procurement mechanisms to attract competition and drive down costs; this trend is occurring in markets with a diversity of institutional frameworks, including those with wholesale power markets. These competitive procurement mechanisms still offer long-term contracts, but the ultimate price of the contract is discovered through competition.

In most cases of a competitive procurement framework, a government or utility issues a call for proposals or tenders for a specified amount of capacity or generation of electricity.¹⁶ VRE developers then submit bids to supply the capacity or energy, and the government or utility evaluates proposals based on price competitiveness, a host of technical criteria, and in some cases economic development or social impact criteria. When a proposal is accepted, the electricity off-taker enters into a PPA with the VRE project owner. The awarded PPA can be a fixed-price contract, or another pricing mechanism such as a Contract for Difference (CfD). In the United Kingdom, a new round of CfD auctions for renewable technologies will begin in April 2017 (Nabarro, 2016).

Properly designed, auctions can help ensure transparency, increase levels of participation, and reduce uncertainties and delays.¹⁷ They can also allow different technologies to compete with one another. Auctions can also be designed to include elements that ensure VRE deployment is done in a relatively system-friendly way, for example by including locational requirements or by aligning results with grid development.

Auctions have been instrumental in lowering the price for wind and solar projects, as some recent examples highlight:

- **Mexico:** the Federal Electricity Commission purchased 1 860 MW of solar PV at a price of USD 0.0501 per kWh (GTM, 2016).
- **India:** The Solar Energy Company of India purchased 950 MW of solar PV in the state of Karnataka at a price of USD 0.066 per kWh (Clean Technica, 2016).
- **Chile:** Solarpack, a Spanish solar PV developer, won the right to supply 280 gigawatt hours of solar PV generation per year with a bid of USD 0.0291 per kWh, scheduled to enter operation in 2019 (Photon, 2016).
- **United Arab Emirates:** the joint Chinese and Japanese consortium JinkoSolar-Marubeni won a tender for 350 MW of solar PV with a bid of USD 0.0242 per kWh, which is expected to begin operating in 2019 (Clean Technica, 2016).

It is worth pointing out that in a limited number of settings, certain VRE projects are being financed and deployed without long-term contracts. In these cases, VRE projects are deployed as merchant generators participating in wholesale electricity markets, and utilising short- or medium-term contracts for portions of their output when economically rational.¹⁸ These projects may also benefit from alternative support schemes that help to reduce project risk.

Recently, a 320 MW solar PV farm in Victoria, Australia, was able to secure financing and initiate construction with no PPA in place (Vorrath, 2017). Australia's wholesale markets, combined with incentives for solar energy, have created a market that is strong enough to support project development without a guaranteed off-taker. Similarly, in Texas, certain wind plants are being financed and built as merchant projects without long-term PPAs in place. In 2014, approximately one-third of new wind projects in Texas were financed based on a combination of long-term (10-

¹⁶ In the past, these competitive procurement frameworks have been technology specific. More recently, there has been a shift toward facilitating competition across all technologies.

¹⁷ For a detailed treatment of auction design elements see IRENA (2015).

¹⁸ Specifically, these VRE projects are forgoing traditional long-term contracts in favour of direct bidding into wholesale day-ahead or spot markets. These shorter-term contracts are often not secured by the time the project is commissioned.

13 years) hedging contracts and direct participation in wholesale markets (NAW, 2015). Projects built in Texas may, however, benefit from the federal investment tax credit (ITC),¹⁹ which lowers capital costs, and the production tax credit, which helps offset revenue uncertainty, as well as the sale of renewable energy certificates to meet the renewable portfolio standard obligation.

Pricing of negative externalities

Accurately reflecting the full cost of power generation is a precondition for taking sound investment and operational decisions, regardless of the policy, market and regulatory frameworks in place. Such externalities include environmental impacts, such as local air pollution and, critically, carbon dioxide (CO₂) emissions.²⁰

Carbon pricing has been introduced or strengthened in a number of countries, and if such trends continue, this will contribute to increasing electricity prices from fossil-fuel generation, which creates more favourable conditions for investment in renewable energy.

In Europe, the EU Emissions Trading System (ETS) was launched in 2005, resulting in a carbon price too low to affect either operational or investment decisions. The introduction of measures, such as a temporary “back-loading” of emissions allowances and the creation of a market stability reserve, are attempts to strengthen the scheme, but have yet to succeed in significantly lifting prices above the low EUR 5 to EUR 7 per tonne of CO₂ (tCO₂) range.

In the United Kingdom and Australia, carbon pricing has also been a source of uncertainty for investors. In the United Kingdom, in 2011 the government introduced a carbon price floor as a top-up tax on the EU ETS. The floor was intended to rise every year to reach GBP 70/tCO₂ by 2030. However, one year after its introduction in 2013, the government decided to cap the floor price until 2021 (Ares and Delebarre, 2016).

In Australia, an ETS with an initial fixed price of AUD 23/tCO₂ was introduced in 2012, with the objective of coupling this price to the EU ETS. Subsequently, the new government elected in 2013 cancelled the policy.

In the United States, an attempt was made in 2010 to introduce a carbon price at the federal level, but the Waxman-Markey Bill failed to pass in the Senate. At a state level, several regional initiatives, such as the Regional Greenhouse Gas Initiative (RGGI) and the California ETS, have been developed, but the resulting carbon prices remain fairly low, in the range of USD 5/tCO₂ to USD 15/tCO₂.

Confronted with the difficulties associated with carbon pricing, certain governments have taken alternative measures to constrain carbon emissions using direct regulation. As an example of direct regulation, in the United States the Obama administration turned to the Environmental Protection Agency (EPA) to implement regulations restricting power-sector CO₂ emissions through the Clean Power Plan (CPP). This programme, however, has been abandoned by the current administration.

Ultimately, carbon pricing is a political construct, i.e. a government intervention designed to stimulate investment and innovation in a certain direction. As such, any investment exposed to a carbon price is exposed to a degree of regulatory risk; this can be mitigated, but never fully

¹⁹ Note that ITC for small wind turbines (up to 100 kW) and large wind turbines are negligible after 2016 and 2019, respectively.

²⁰ Certain authors also consider the potential cost of dealing with the uncertainty and variability of wind and solar power to be an externality. However, such associated costs can be priced into the market without the introduction of regulatory instruments. The definition and pricing of such “integration costs” face a number of practical and conceptual challenges; see (IEA, 2014; IEA/NEA, 2015) for details.

removed. This set-up has important implications for the investment risks associated with both high-carbon and low-carbon technologies: high carbon prices, or the expectation of high prices, may deter investment in carbon intensive options, but low carbon prices, or the risk of low prices, may thwart investment in cleaner options. Moreover, an investment made under the assumption of a high carbon price may become uneconomic if the government decides to reduce or remove the price (IEA, 2015).

Unlocking sufficient levels of flexibility

In most power systems, improved operations and system-friendly VRE deployment will not be sufficient to reach energy policy objectives. Additional investment in flexible resources will also be necessary. Securing such investment becomes an important aspect of the overall policy, regulatory and market frameworks. Sufficient flexibility can be delivered through an appropriate mix of the four power system resources: flexible generation, grid infrastructure, demand response and storage (IEA, 2014).

Flexible generation

Flexible generation (predominantly from thermal generators) is often a highly cost-effective, mature and readily available option to balance VRE variability and uncertainty. This option is critical to ensuring security of supply during sustained periods of low VRE generation. Rather than implementing dedicated mechanisms to incentivise power plant flexibility, other aspects of the policy, market and regulatory frameworks should be designed with a view to remunerating flexible generation. The examples provided in the section on operational efficiency, scarcity pricing and managing asset retirement are all relevant in this regard.

Demand-side integration

Demand response can be a key resource for power systems. A participatory demand side can be cast in many moulds, depending on:

- Who is participating (e.g. regulated customers, larger industrial users).
- How they are participating (e.g. via regulated programmes run by distribution utilities, deregulated private-sector aggregation or direct market participation).
- How compensation levels are determined (e.g. regulated compensation versus market-based compensation).

It is important to note that much of the growing demand-side participation observed today continues to be driven by peak demand reduction. Looking ahead demand-side resources will increasingly help to meet additional system flexibility needs.

France has been a front-runner in the implementation of time-of-use and dynamic electricity tariffs. In the 1960s, the national utility, EDF, was already offering differentiated electricity tariffs (day/night and seasonal). The EJP (*effacement jour de pointe*) tariff introduced in the 1980s is a form of critical peak pricing that helped grow the country's demand response capacity to 6.5 GW in 2000 (Veyrenc, 2013). Over the years, the availability of these tariffs has been reduced due to electricity market liberalisation, and the capacity subsequently declined to 3 GW.

In France, the first demand response operators entered the commercial and industrial market in 2003, and the residential market in 2007. They offered consumers the ability to manage their electricity demand in exchange for financial compensation. The French TSO, RTE, opened up participation in the energy and balancing markets, but the minimum threshold for eligibility was

10 MW, automatically keeping out direct participation from residential consumers as well as small and medium-sized companies.

One outstanding question in this system related to the remuneration of load shifting contracted by new aggregators. To address this, in 2012 France introduced new rules called NEBEF (*notifications d'échange de blocs d'effacement*), making RTE the only intermediary through which bids and offers for load shifting can be made..

With the introduction of a capacity remuneration mechanism in France in January 2015, demand response can become fully eligible to participate and therefore the regulated incentive mechanism will be cancelled. Aggregators will participate and be remunerated on the capacity mechanisms. In addition, a support mechanism was introduced under which aggregators benefit from a financial incentive, financed by the regulated electricity tariff.

Many other countries in the European Union have since opened electricity markets for demand response participation, and the European Commission has issued guidance for member states to improve demand-side participation in electricity markets (JRC, 2016). In the United States, the wholesale power market, PJM, allows for demand-side resource to be bid into wholesale energy and capacity markets. Demand response in that market is primarily provided by private-sector aggregators (McAnany, 2017). California is launching a “Demand Response Auction Mechanism” pilot programme, where the state’s three large investor-owned utilities will partner with the private sector to aggregate retail customers for demand response, and bid them into the day-ahead electricity market (TURN, 2014). ERCOT contracts for half of its primary frequency response from demand resources.

Regulated distribution utilities are also increasingly offering pathways for small customers to participate in demand response, driven by regulatory mandates or incentives. For instance, Hawaiian Electric Company offers monthly bill credit to residential customers in return for enabling centralised controllability of their water heaters and air conditioners (Hawaiian Electric, 2017a). For commercial and industrial customers over 50 kW, a separate “fast demand response” programme provides relevant communications infrastructure and financial incentives to facilitate demand reductions during times of peak demand, reliability events, or to help integrate VRE (Hawaiian Electric, 2017b).

Storage

Electricity storage has played a much greater role in providing power system flexibility in recent years, particularly in Europe of the United States. However, its relatively high cost remains an important barrier to its deployment. To be cost-effective, battery electricity storage currently needs to combine multiple revenue streams, driven by the broad range of services it can provide. This can challenge existing policy, market and regulatory frameworks, because it may be challenging for one single economic actor to access all possible value streams of a storage asset.

Nevertheless, storage has been making inroads in a number of cases. A prominent example is the recent auction for a new type of system service in the United Kingdom. Enhanced Frequency Response (EFR) is a novel service identified as a priority by National Grid as part of its System Operability Framework to deal with renewable energy integration (National Grid, 2016). The service was procured via a technology-neutral auction mechanism. In a highly competitive auction, 201 MW of EFR were procured at a total cost of GBP 65.95 million with an average price of GBP 9.44/MW per hour of EFR (National Grid, 2017). A surprise in the auction process was the success of electric batteries, which took the entire auction. This reflects both the increasing competitiveness of battery storage as well as the specific technical requirements for EFR.

A further challenge for establishing a level playing field for storage is its hybrid nature; it can be a load and a generator depending on whether it is charging or discharging. In the United States, FERC has proposed a tariff revision to create consistent rules in ISOs/RTOs for participation of electric storage. This measure would also explicitly define distributed energy resource aggregators as a market participant, eligible to compete in wholesale markets. Currently ISOs/RTOs are allowed to limit how certain resources are able to participate. For example, in MISO, “stored energy resources” are only allowed to provide regulation service. The FERC rule would require that ISOs/RTOs change tariffs to explicitly allow storage to participate in wholesale markets (FERC, 2016b)

Grid investment

With the exception of limited investment in merchant transmission lines, networks continue largely to be viewed as natural monopolies that need to be regulated. Regulatory reforms have therefore focused on incentive-based regulation aimed at replicating the efficiency of markets. This has been supported by the development of independent regulatory bodies. Still, regulators and policy makers have not always fully adapted the regulatory framework to be fit for decarbonisation. In particular, the deployment of renewable resources can often outpace network development. Network development will need to anticipate where renewables are likely to be built, while policy makers and regulators will need to explicitly link incentives for new transmission lines to other policies that support investment in renewables. The Competitive Renewable Energy Zones (CREZs) in Texas offer one example of such a policy (Figure 4.5).

Figure 4.5 • CREZs in Texas

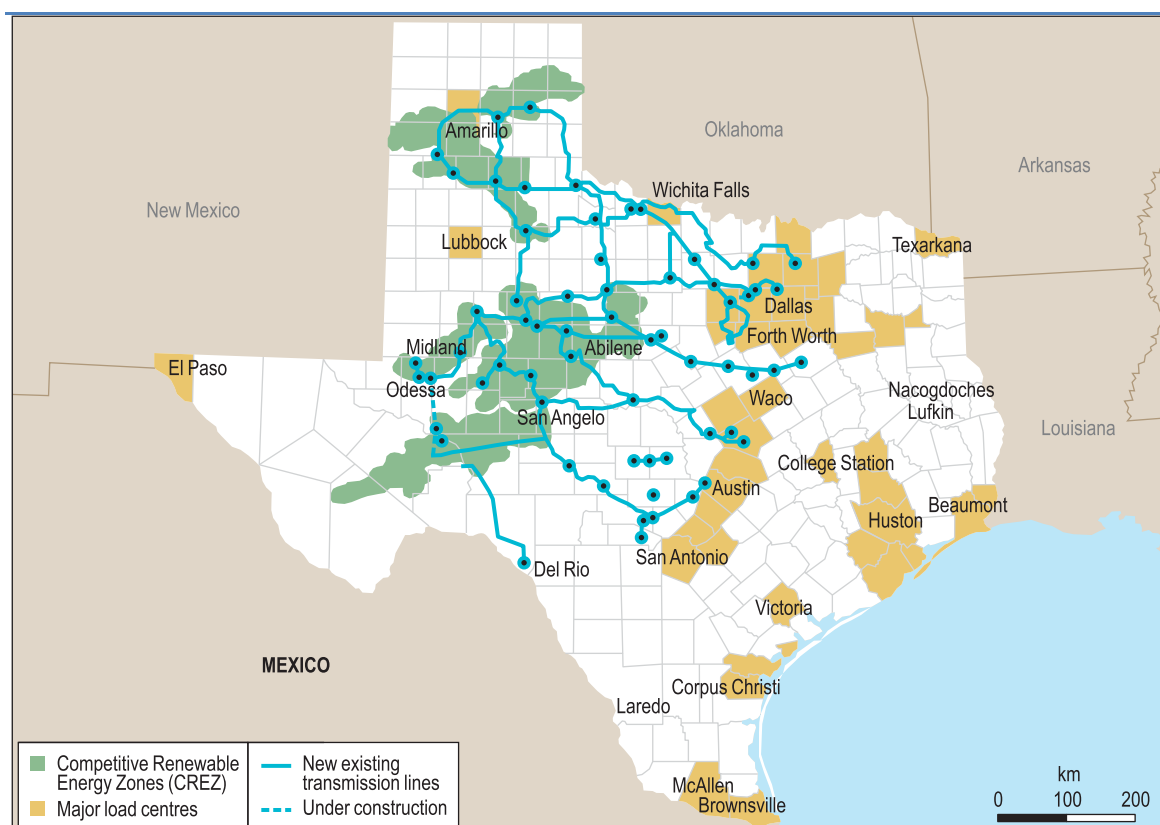

This map is without prejudice to the status of or sovereignty over any territory, to the delimitation of international frontiers and boundaries and to the name of any territory, city or area.

Source: reprinted from IEA (2016), *Re-powering markets: Market Design and Regulation during the Transition to Low-Carbon Power Systems*

Key point • CREZs were created as a proactive means to alleviate grid congestion by designating renewable sources in suitable areas of the grid.

As noted above, regional expansion of power systems allows for the more efficient integration of variable generating resources. Fully reaping the benefits of regional integration of electricity markets, however, requires co-operation at a regulatory, as well as operational, level. Regulatory co-ordination across borders, however, can be difficult. Efficient development of cross-border infrastructure requires, for example, the development of common methodologies for cost-benefit tests. In Europe, the costs of cross-border infrastructure have generally been split on a 50:50 basis – a simple rule that is rarely the most economically efficient. Looking ahead, benefit tests may also need to look beyond pure economic benefits, taking into account, for example, reliability benefits as well. Power systems in member economies of the Organisation for Economic Co-operation and Development, however, tend to already be highly reliable, making the reliability benefits of new infrastructure difficult to quantify.

References

- 50Hertz Transmission GmbH (2017), “The transmission perspective”, presentation by Sebastian Ziegler at the 8th European Power Summit, Brussels, 21 March.
- AEMC (2017a), *Five Minute Settlement*, Australian Energy Market Commission, Melbourne, www.aemc.gov.au/Rule-Changes/Five-Minute-Settlement.
- AEMC (2017b), *System Security Market Frameworks Review*, Australian Energy Market Commission, Melbourne.
- AEMO (2017a), “Generation Information Page”, Australian Energy Market Operator, www.aemo.com.au/Electricity/National-Electricity-Market-NEM/Planning-and-forecasting/Generation-information (accessed 19 March 2017).
- AEMO (2017b), *Future Power System Security Program – Reports and Analysis*, Australian Energy Market Operator, Melbourne.
- Alaywan, Z., T. Wu and A.D. Papalexopoulos (2014), “Transitioning the California Market from a Zonal to a Nodal Framework: An Operational Perspective”, IEEE PES PSCE Meeting 2004, New York.
- Ares, E. and J. Delebarre (2016), *The Carbon Price Floor*, The House of Commons Library, London.
- B&B (2016), *Refining Electricity Imbalance and Balancing Prices*, Bird & Bird, www.twobirds.com/en/news/articles/2016/global/refining-electricity-imbalance-and-balancing-prices.
- CAISO (2017a), *Western Energy Imbalance Market (EIM)*, <https://www.caiso.com/informed/Pages/EIMOverview/Default.aspx>
- CAISO (2017b), *Western EIM Benefits Report Fourth Quarter 2016*, California ISO, www.caiso.com/Documents/ISO-EIMBenefitsReportQ4_2016.pdf.
- CAISO (2014), *Flexible Ramping Products*, California ISO, www.caiso.com/Documents/RevisedStrawProposal_FlexibleRampingProduct_includingFMM-EIM.pdf.
- Clean Technica (2016), *Lowest-Ever Solar Price Bid (2.42¢/kWh) Dropped In Abu Dhabi By JinkoSolar and Marubeni Score* (article), <https://cleantechnica.com/2016/09/20/lowest-ever-solar-price-bid-2-42%2A2kwh-dropped-abu-dhabi-jinkosolar-marubeni-score/>.
- CRE (2017), “6 questions pour comprendre le mécanisme de capacité en France” [6 questions to understand the capacity mechanism in France], *Décryptages*, Vol. 51, p. 6, Commission de

- Régulation de l'Énergie, www.cre.fr/documents/publications/decryptages/decryptages-numero-51.
- EC (2016), *Final Report of the Sector Inquiry on Capacity Mechanisms*, European Commission, http://ec.europa.eu/competition/sectors/energy/capacity_mechanisms_final_report_en.pdf.
- Eirgrid/SONI (2016), *DS3 Programme Operational Capability Outlook 2016*, Eirgrid/System Operator Northern Ireland.
- Eirgrid/SONI (2015), *DS3 RoCoF Alternative Solutions Phase 1 Concluding Note*, Eirgrid/System Operator Northern Ireland.
- ENTSO-E (2017), "Regional security coordinators" (factsheet), European Network of Transmission System Operators for Electricity, www.entsoe.eu/Documents/SOC%20documents/rscis_short_final.pdf.
- ENTSO-E (2016), "Options for the future of power system regional coordination" (report), European Network of Transmission System Operators for Electricity, www.entsoe.eu/Documents/Publications/Position%20papers%20and%20reports/entsoe_fti_161207.pdf.
- ERCOT (2017), *Real-Time Market*, Electric Reliability Council of Texas, www.ercot.com/mktinfo/rtm.
- FERC (2016a), *Settlement Intervals and Shortage Pricing in Markets Operated by Regional Transmission Organizations and Independent System Operators*, Federal Energy Regulatory Commission, Washington, DC, www.ferc.gov/whats-new/comm-meet/2016/061616/E-2.pdf.
- FERC (2016b), *Electric Storage Participation in Markets Operated by Regional Transmission Organizations and Independent System Operators*, Federal Energy Regulatory Commission, Washington, DC, www.ferc.gov/whats-new/comm-meet/2016/111716/E-1.pdf.
- Green (2007), "Nodal pricing of electricity: how much does it cost to get it wrong?", *Journal of Regulatory Economics*, Vol. 31, pp. 125-149.
- GTM (2016), "Solar stuns in Mexico's first Clean Energy Auction: 1,860MW won at \$50.7 per MWh", *Green Tech Media*, www.greentechmedia.com/articles/read/Solar-Stuns-in-Mexicos-First-Clean-Energy-Auction-1860-MW-Won-at-50.7-P.
- Hawaiian Electric (2017a), *Residential Solutions* (webpage), Hawaiian Electric, www.hawaiianelectric.com/save-energy-and-money/demand-response/residential-solutions.
- Hawaiian Electric (2017b), "Demand response: Fast demand response" (webpage), Hawaiian Electric, www.hawaiianelectric.com/save-energy-and-money/demand-response/fast-demand-response.
- Hesseling, D. and F. Hernández (2015), *A Bridge to 2025*, Agency for the Cooperation of Energy Regulators, www.acer.europa.eu/Events/A-Bridge-to-2025-Delivering-the-Energy-Union/Documents/Bridge%20to%202025_2.2_Flexibility%20and%20RES.pdf.
- Hogan, W.W. (1999), *Market-Based Transmission Investments and Competitive Electricity Markets*, Harvard University, Massachusetts.
- Hogan, W.W. (1992), *Contract Networks for Electric Power Transmission: Technical Reference*, Harvard University, Massachusetts.
- IEA (International Energy Agency) (2016), *Re-powering markets: Market Design and Regulation during the Transition to Low-Carbon Power Systems*, OECD/IEA, Paris.

- IEA (2015), *Energy Technology Perspectives 2015: Mobilising Innovation to Accelerate Climate Action*, OECD/IEA, Paris.
- IEA (2014), *The Power of Transformation*, OECD/IEA, Paris.
- IEA/NEA (2015), *Projected Costs of Generation Electricity: 2015 Edition*, OECD/IEA/Nuclear Energy Agency, Paris.
- IRENA (2015), *Renewable Energy Auctions: A Guide to Design*, International Renewable Energy Agency, www.irena.org/DocumentDownloads/Publications/IRENA_RE_Auctions_Guide_2015_1_summary.pdf.
- JRC (2016), *Demand Response Status in EU Member States*, EU Joint Research Centre, <http://publications.jrc.ec.europa.eu/repository/bitstream/JRC101191/Idna27998enn.pdf>.
- McAnany, J. (2017), *2016 Demand Response Operations Markets Activity Report: March 2017*, PJM, Norristown, PA.
- Monitoring Analytics (2017), *State of the Market Report for PJM*, www.monitoringanalytics.com/reports/PJM_State_of_the_Market/2016/2016-som-pjm-volume2.pdf.
- Nabarro (2016), “Contracts for difference – UK Government announces next round” (webpage), Nabarro, www.nabarro.com/insight/alerts/2016/november/contracts-for-difference-uk-government-announces-next-round/.
- National Grid (2016), *System Operability Framework*, National Grid, www2.nationalgrid.com/UK/Industry-information/Future-of-Energy/System-Operability-Framework/.
- National Grid (2017), *Enhanced Frequency Response*, National Grid, www2.nationalgrid.com/Enhanced-Frequency-Response.aspx.
- NAW (2015) *On the Rebound: Merchant Wind Projects Becoming Popular Alternative For U.S. Off-Take Agreements*, North American Wind Power, <http://nawindpower.com/on-the-rebound-merchant-wind-projects-becoming-popular-alternative-for-us-off-take-agreements>.
- Neuhoff, K. and R. Boyd (2011), *International Experiences of Nodal Pricing Implementation*, Climate Policy Initiative, Berlin.
- NREL (2013), *Examination of Potential Benefits of an Energy Imbalance Market in the Western Interconnection*, National Renewable Energy Laboratory, www.nrel.gov/docs/fy13osti/57115.pdf.
- ODI (2016), *Rethinking Power Markets: Capacity Mechanism and Decarbonisation*, Overseas Development Institute, www.odi.org/sites/odi.org.uk/files/resource-documents/10569.pdf.
- Photon (2016), “Solarpack to build 120 MW solar park in Chile” (webpage), Photon, www.photon.info/en/news/solarpack-build-120-mw-solar-park-chile.
- PJM (2016), Shortage Pricing ORDC - Order 825 (webpage), PJM, www.pjm.com/~media/committees-groups/committees/mic/20161102/20161102-item-09b1-shortage-ordc-update.ashx.
- POSOLO (2016), *Detailed Procedure for Ancillary Services Operations*, Power System Operation Corporation Ltd., National Load Dispatch Centre (NLDC), New Delhi.

RAP (2012), "What lies 'Beyond Capacity Markets'?" (webpage), Regulatory Assistance Project, www.raponline.org/wp-content/uploads/2016/05/rap-hogan-whatliesbeyondcapacitymarkets-2012-aug-14.pdf.

Schweppe, F. et al. (1988), *Spot Pricing of Electricity*, Kluwer Academic Publishers, Massachusetts.

Sun Metals (2016), *Proposed Rule Change: To have 5 minutes Settlement Pricing Instead of 30 Minute Average Settlement Pricing*, Sun Metals, <http://www.aemc.gov.au/getattachment/6a518011-533d-49dd-bb27-e6e8175bcabd/Rule-change-request.aspx>.

Terna (2017), *Remunerazione della Regolazione Primaria* [Primary Regulation Remuneration], www.terna.it/it-it/sistemaelettrico/mercatoelettrico/remunerazionedellaregolazioneprimaria.aspx.

TURN (2014), *Opening Brief of the Utility Reform Network on the Demand Response Auction Mechanism*, The Utility Reform Network, ftp://ftp2.cpuc.ca.gov/PG&E20150130ResponseToA1312012Ruling/2014/08/SB_GT&S_0350923.pdf.

Veyrenc, T. (2013), "L'intégration de la demand response sur les marchés d'électricité" [The integration of demand response in electricity markets], presentation, October.

Vorrath, S. (2017), "Victoria ends Big Solar drought with 320MW new capacity by 2018." *RenewEconomy*, <http://reneweconomy.com.au/victoria-ends-big-solar-drought-320mw-new-capacity-2018/>.

Zhang, H. and S. Du (2016), "The design and practice of the power regulation ancillary service market in the Northeast China grid", *15th Wind Integration Workshop*, Vienna, Austria.

Chapter 5. Topical focus: Evolution of local grids

HIGHLIGHTS

- Low- and medium-voltage grids are traditionally designed to passively distribute power from high-voltage networks to end users at lower voltages. The way these “local grids” need to be planned and operated is changing, driven by uptake of distributed energy resources (DER), the smartening of local grids and electrification of end-use sectors.
- These trends are beginning to reshape the low- and medium-voltage parts of the energy system. A successful transition rests on changes along technical, economic and institutional dimensions:
 - On a technical level, DER can cause more dynamic energy flows, possibly posing technical challenges that require changes in system operations.
 - Economically, new choices for consumers raise the need for electricity tariff reform.
 - Institutionally, the rise of new actors, such as aggregators, drives changes to roles and responsibilities across the sector.
- While the long-term future of local grids is subject to considerable uncertainty, a proactive approach to managing change is needed to maintain reliability and cost-effectiveness.

This topical focus provides an overview of recent trends and future prospects in local grids. In this context, local grids primarily refer to the low- and medium-voltage levels of the electricity grid. The term local grid is used, rather than distribution grid, so as to distinguish between the traditional role of the distribution grid and its evolution into a much more complex, actively controlled network. The term local grid is also understood to encompass other network infrastructure, the planning and operation of which is co-ordinated with the electricity network. Heating, cooling and electric mobility are relevant in this context.

A paradigm shift – local grids in future energy systems

Low- and medium-voltage grids are traditionally designed to passively distribute power from high-voltage networks to end users at lower voltages. Planning standards, which dictated the provision of electric power distribution infrastructure, were based on simplified and often conservative assumptions about future electricity demand. Once in place, there was little need for active management, and hence system operation often amounted to clearing faults and replacing components as and when needed. The demand profile from smaller, residential consumers was reasonably well understood and fairly homogeneous, so it was usually sufficient to read meters once a year or every few months. Demand was generally not actively managed – apart from simple systems that prioritised use at night (e.g. electric space heating, water heaters).

This picture has begun to change. A number of drivers are aligning to change the way local grids are planned and operated today, including substantial penetration of DERs, digitalization, business model innovation, and cross sector coupling between electricity, heat and transportation. Looking further into the future, these trends may substantially reshape this part of the energy system, increasing its importance as a critical part of a more reliable, cost-effective and clean energy system.

Current drivers for change

Principal drivers currently underpinning evolution in local grids include the uptake of DER, the smartening of local grids by utilities (including improved accuracy of price signals and/or revenue collection), and the electrification of heating and transport.

Uptake of DER fosters decentralisation of supply

DER are typically modular or small-scale technologies that empower end users to produce energy locally and adapt the timing of their consumption to the needs of the system. This signifies a break away from the historic top-down supply structure that has marked electricity systems for more than a century. The most important DER driving change in local grids in recent years has been rooftop solar photovoltaics (PV).

Global installed capacity of rooftop solar PV grew from 10.7 gigawatts (GW) in 2010 to 45.7 GW in 2016 (Figure 5.1). In the same period, commercial-scale installations²¹ increased by over 72 GW to reach 91.8 GW in 2016. Growth in utility-scale projects was 127 GW, reaching a total capacity of 133.7 GW in 2016 (IEA, 2016a).

The residential and commercial segments combined represent 45% of total installed solar capacity in the United States, and as much as 72% in Germany. In 2016, the share of households fitted with rooftop PV was 16% across all Australia, with 26% in South Australia and 25% in Queensland. The share of households with rooftop solar PV systems was 15% in Hawaii, 7% in Belgium and 4% in Germany (IEA, 2016a).

Global installed capacity of residential solar PV is expected to reach 73 GW by 2021, a 60% increase from 2016. This increase is bound to prompt changes in local grids.

Figure 5.1 • Global installed capacity of residential-scale solar PV, 2010-15

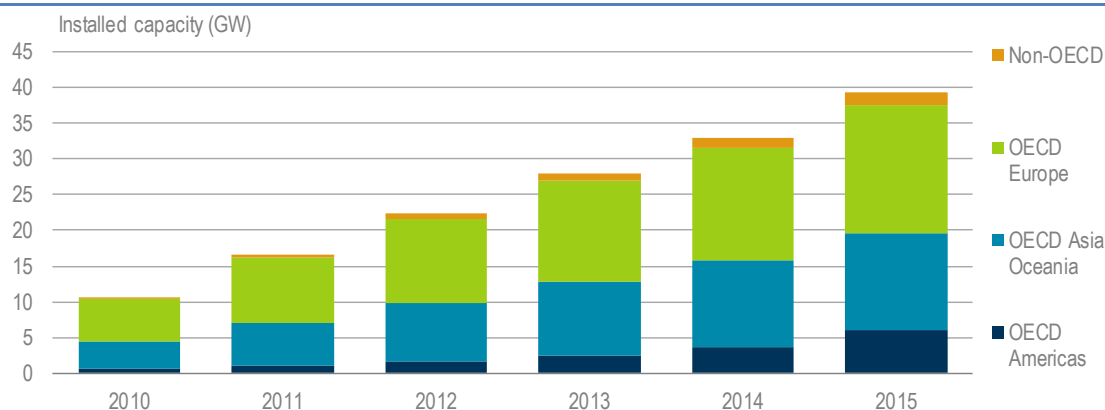

Notes: Residential PV is defined as smaller than 20 kilowatts (kW) installed capacity; OECD = Organisation for Economic Co-operation and Development.

Source: IEA (2016a), *Medium-Term Renewable Energy Market Report 2016*.

Key point • Residential solar PV capacity is on a continued growth trajectory globally.

Smartening of local grids by utilities

Over recent years, grid companies have tested and deployed a wide range of technologies to increase the intelligence of local grids. The roll-out of smart meters in many power systems today is an important step towards a more refined tracking of electricity consumption. The move to

²¹ Residential systems are defined as <20 kW and commercial-scale installations as between 20 kW and 1 000 kW installed capacity.

higher levels of sophistication in the planning and operation of local grids represents a shift away from traditional, less proactive approaches for local grid management.

Utility-led initiatives often focus on improved situational awareness by applying information and communication technology (ICT). In South Africa, the Revenue Enhancement Project aims to equip five municipalities with advanced metering infrastructure that enables better management of the customer base, a reduction of technical losses and improved revenue collection.

In 2016 the French transmission system operator (TSO), RTE (*Réseau de Transport d'Électricité*) and the distribution system operator (DSO), ERDF (*Électricité Réseau Distribution France*), led the implementation of a “smart substation” demonstration to highlight the possibilities of increased co-ordination between different voltage levels. A digital interface between high-voltage equipment and intelligent electronic devices was established, alongside an open information technology (IT) architecture that enables highly detailed DER monitoring, improved incident diagnosis and automated protection schemes (ISGAN, 2016)

These investments enable improved operational efficiencies, reduced technical and non-technical losses, and increased reliability. They often allow larger volumes of DER to be hosted. In Austria, a pilot project launched in 2014 identified a number of control options for voltage band management that were successful in local grids with a high share of distributed generation. It found that by combining active decentralised network management, smart planning and monitoring, the hosting capacity of local grids could be increased by 20% (ISGAN, 2016).

Electrification of heating and transport

Demand for low-intensity heat, such as space heating, and individual transport is predominantly met by fossil fuel sources. Over recent years, a growing number of innovative and increasingly cost-competitive electric supply alternatives have been emerging to provide these services. The deployment of these technologies offers a number of benefits. First, heat pumps – coupled with thermal energy storage capability – and electric vehicles (EVs) can help shift demand across time, reducing the need for expensive peak-time generation and helping to integrate VRE. Second, depending on the evolution of the carbon intensity of the electricity mix, electrification can help decarbonise these energy services. Moreover, shifting to electric transport options can improve local air quality, especially in large urban areas.

The global stock of battery-electric vehicles (BEVs) and plug-in hybrid electric vehicles (PHEVs) surpassed the 2 million mark in 2016, with strong growth foreseen in coming years. In addition, more than 200 million electric two-wheelers are on the roads today (IEA, 2017). The connection size for EV charging, as measured by the amount of power it can draw from the network, and the degree of co-ordination between EV charging infrastructure and effective markets providing real-time price signals will affect how much instantaneous demand is added to the power system.

Although electric heating has been fairly common in a number of countries for decades (e.g. France and Norway), electrification of heating has received renewed attention in the context of the integration of VRE resources and the broader decarbonisation of the energy system.

Since demand for space heating and EV charging is strongly localised,²² the contribution of these technologies to overall system flexibility will need to be harnessed at the level of local grids (Figure 5.2).

²² Privately owned home EV chargers are estimated to account for 86% of globally installed EV charging stock (IEA, 2016b).

Figure 5.2 • Overview of selected options for electrification of heating and transport

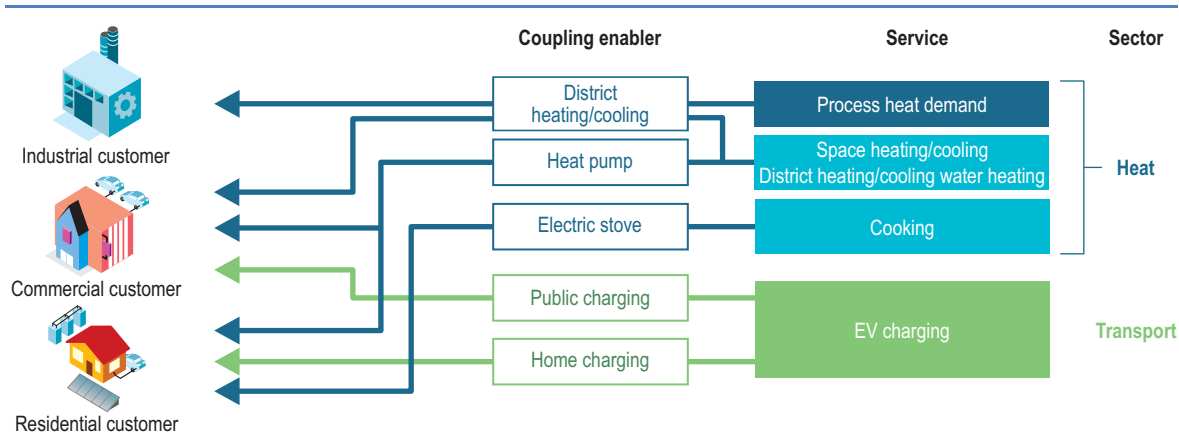

Key point • Local grids are vital for supporting cross-sector coupling with heat and transport.

Long-term vision for local grids

As power system transformation processes continue, local grids may emerge as a central component of a clean, reliable and cost-effective energy system. The following trends could combine to create such an outcome:

- the large-scale adoption of DER, turning these resources into an important part of the power supply
- mass enrolment of demand response, enabled by digitalization and the effective integration of intelligent end-use devices
- electrification of heating and transport, driven by decarbonisation and local pollution objectives, as well as the need to integrate VRE.

The cost-optimal share of DER, in particular decentralised solar PV, is subject to considerable uncertainty. For example, if the decline in the cost of EVs continues and the installation of charging infrastructure triggers upgrades to local grid infrastructure, much higher shares of decentralised solar PV could be integrated at very little or no incremental cost. Moreover, the economic rationale for DER deployment may differ strongly compared to investments in large-scale generation. Private citizens may prefer to own DER assets, even if this increases rather than reduces their overall energy cost, due to other considerations.

As a result of the rising intelligence of all grid components, all the way down to individual smart appliances, local grids could facilitate bidirectional flows of both electricity and data, giving rise to much richer and more complex interactions between devices on the grid (Figure 5.3).

Figure 5.3 • Impact of decentralisation and digitalization on local power grids

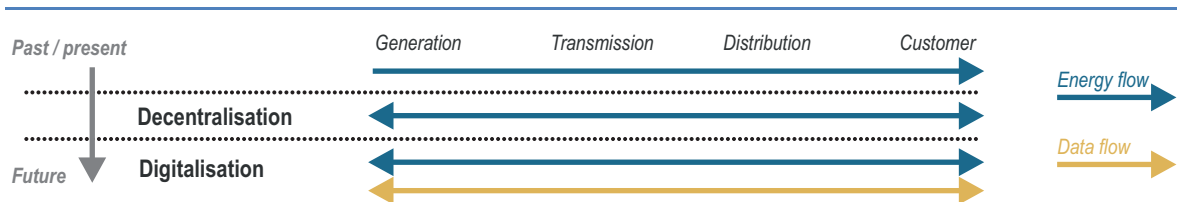

Key point • The combination of decentralisation and digitalization introduces bidirectional power and data flows.

Due to a combination of technological and cost improvements, as well as more stringent equipment standards, modern household appliances are becoming smarter. IT allows for communication and a degree of control between smart appliances, energy management systems (EMS), aggregators and other grid assets. Smarter operation signifies that appliances shift consumption away from moments of peak demand. Abundant opportunities exist in warmer climates to introduce automated, time-responsive air-conditioning equipment that adjusts power consumption levels to the time of day, to price signals and to user preferences.

EMS can use real-time data on the grid situation and market prices to optimise energy flows within a home, a building, at district or even at city level throughout the day. Importantly, by automatically making decisions on behalf of end users, within pre-established boundary conditions, EMS can bring much greater demand response to fruition, compared to a situation where each end user manually responds to price signals.

Such enhanced control capabilities are instrumental in ensuring the efficient uptake of heat pumps, EVs and other end-use technologies such as intelligent thermometers and battery storage systems. In the 450 Scenario²³ of the IEA 2016 *World Energy Outlook*, the combined stock of BEVs and PHEVs reaches 710 million by 2040 (IEA, 2016c). It is worth noting that a single passenger vehicle may consume 50 kW to 100 kW when quick charging. Managing these loads in an intelligent fashion will be critical for efficient and reliable system operations.

More generally, a successful transition is one that holistically considers three aspects – or layers – of the system: technical, economic and institutional. The technical layer focuses on the flow of energy between source and load. The economic perspective looks at monetary flows between various market participants. Finally, the institutional layer considers flows of information and investigates the impact of power system transformation on the division of roles and responsibilities.

Each layer functions by different rules and requires different types of intervention. Technology and business model innovation, policy reform and updated market rules can drive change in their immediate layer, but can also directly or indirectly affect the status quo in different parts of the energy system. The introduction of EMS, for instance, is likely to cause change in each layer: temporal demand shift (technical), bill reduction (economic), and co-ordination of control signals and data ownership (institutional).

Lack of progress in one dimension can hamper progress in another. For example, if there is no clear way to monetise the demand response potential held by DER, or if certain administrative obstacles persist, third-party aggregators are less motivated to combine the flexibility existing across a wide portfolio of businesses and households.

The remainder of this topical focus discusses aspects of these three dimensions as follows: in the first section, the technical perspective of local grids is discussed; the next section takes an economic perspective, discussing tariff design and compensation for services provided by DER; the final section in this chapter focuses on institutional issues, revisiting evolving roles and responsibilities in local grids.

Before turning to these three dimensions, it is worth briefly introducing the concept of digitalization in the context of local grids to lay the foundation for further discussion.

²³ The 450 Scenario provides a 50% chance of limiting global average temperature increase to 2°C.

How to foster the opportunities of digitalization

For the energy system, digitalization refers to the innovative use of ICT, in particular the large-scale rollout of smart devices and sensors in equipment where this has not been the case in the past, and the use of big data collection and analytics to increase the efficiency and productivity of energy-related activities. Digitalization affects the generation, transmission, distribution and consumption of electricity and other utilities, such as heat and gas.

Page | 84

Uptake of digital monitoring and control technologies in the generation and transmission segments of the electricity system has been an important trend for several decades (ISGAN, 2016). Today, this is spreading deeper into the system, into local grids and towards the edge of the grid.

The control features and data that are obtained via the deployment of smart sensors and similar devices provide an opportunity to offer new types of service. For instance, as sector coupling advances, EMS can co-optimize the flow of power, gas and heat in response to prices and consumers' demands for services. In combination with DER, such as intelligent connected appliances and battery storage systems, EMS can open up substantial opportunities for demand response.

Enhanced communication and control enable third-party aggregators to bundle the demand response of a portfolio of small end users. In certain markets, such as France and Pennsylvania-New Jersey-Maryland (PJM) in the northeastern United States, it is possible to bid aggregated demand response flexibility into system services markets. As the transaction cost for modifying the consumption levels of a large number of small users continues to come down, such aggregated demand response will become increasingly competitive with demand response from industrial and larger commercial consumers (EPRG, 2016).

However, barriers impeding the effective participation of end users as both consumers and producers of electricity and heat must be addressed. The retroactive application of lower compensation for grid injection in certain countries hurt investor confidence and substantially reduced deployment in recent years. In many cases, third-party aggregation of end users is not allowed at all. In the minority of European countries where it is possible, various technical or administrative barriers persist (SEDC, 2015).

Looking further into the future, digitalization may support new business models in which behavioural data linked to electricity consumption becomes a source of value itself. As a new element in power systems, digital capabilities, and the issues of data management that they entail, call for a coherent reassessment of policy, regulatory and market frameworks. This process is likely to *follow* the adoption of the technologies that underpin digitalization and raises a number of regulatory challenges. Issues of data ownership and access will become increasingly important, in particular with regard to data privacy and security of individual end users (Box 5.1).

Policy makers wanting to encourage the development of demand response will need to consider whether regulation should take an opt-in or and opt-out approach to customer authorisation of data collection and use. Opt-out programmes, which minimise the consents a customer must give, are likely to make mass participation in demand response markets more likely. Similarly, the development of energy management services markets could be facilitated by giving customers a range of options in relation to how much information they are willing to share. A voluntary code of conduct developed by the US Department of Energy and the Federal Smart Grid Task Force in 2015 provides a model in seeking to balance concerns relating to data privacy, the positive policy objective of fostering innovation in demand response markets, and the operational needs of utilities (US DOE, 2015).

Box 5.1 • Data privacy considerations

Smart grid demand response technology requires the widespread collection and analysis of vast quantities of consumer-specific, real-time electricity usage data. This may include records of individual energy use events, such as heating water for a shower. Concerns are growing that current legal frameworks do not adequately establish who will own this data, who will be able to access and use it for which purposes, and how exactly confidentiality can be protected. Utilities, competitive energy suppliers, aggregators and/or EMS manufacturers might need to establish:

- Administrative and technical security measures to protect and anonymise customer data.
- Procedures to maintain data quality and integrity, including means for consumers to access and correct any stored personal data.
- Transparency about the purposes for which data will be used, as well as use limitations.
- Means for consumers to give consent prior to any release of data, particularly to third parties.
- Means for consumers to choose to share their data with third parties when the release of such information is beneficial for them, or to freely transfer their data between service providers.

In order to reap the benefits of digitalization while maintaining secure system operations, three features of the power system need to be reconsidered: first, the technical parameters for secure system operations; second, the economic signals in the power system; and third, the roles and responsibilities that drive energy and data flows. These are discussed in the following sections.

Secure and effective system operations under a high degree of decentralisation

Addressing DER – a focus on solar PV

With the introduction of DER, the traditional approach to local grids no longer suffices. DER may cause more dynamic energy flows, possibly posing technical challenges that require technical and operational changes. It is possible to identify three stages of technical impacts (Figure 5.4).

While distributed solar PV can make local grid operations more challenging, rooftop solar PV systems can also minimise negative impacts on the grid and, in some cases, even improve technical parameters by providing technical services that support grid stability. Using smart inverter technology, solar PV can provide voltage management capabilities and power system support services, as well as improved communications and interactivity. Adding battery storage improves the provision of these services, and has the important benefit of shifting some or all of the generated power for consumption to times of higher system demand (Figure 5.5). These services can have value for local grids; at high shares of decentralised solar PV, they can also become relevant to ensuring security of supply.

Figure 5.4 • Technical impacts of rising deployment of distributed solar PV generation

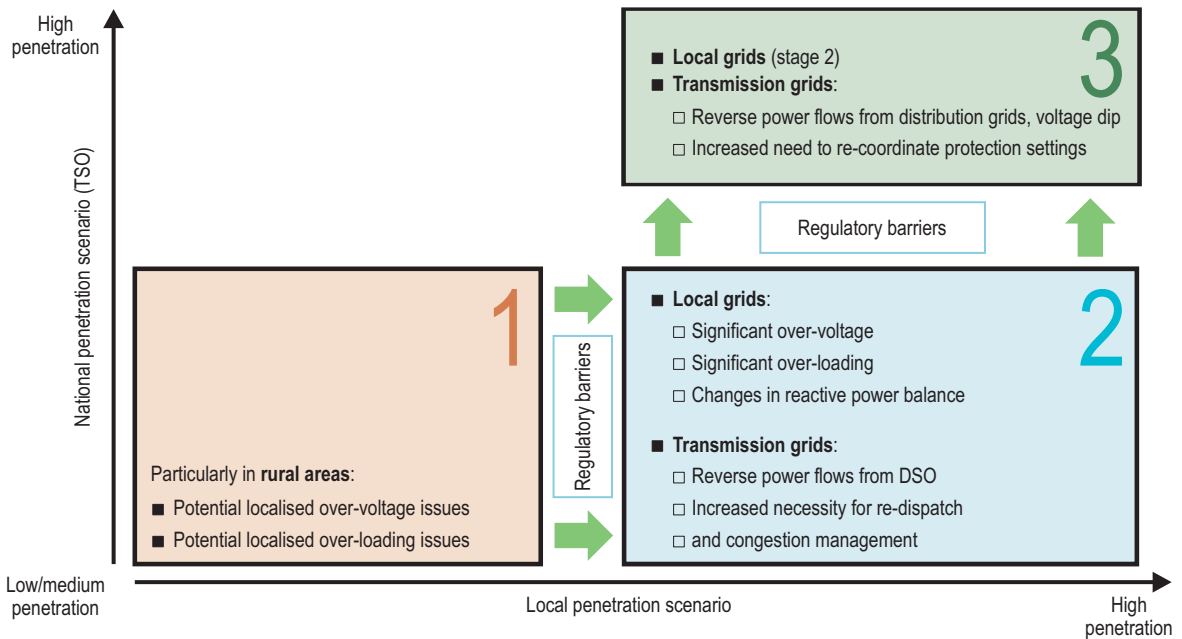

Source: IEA PVPS (2014), *Transition from Uni-Directional to Bi-Directional Distribution Grids*.

Key point • As decentralised solar PV increases, a new set of technical challenges must be overcome.

Figure 5.5 • Technical services available from solar PV systems

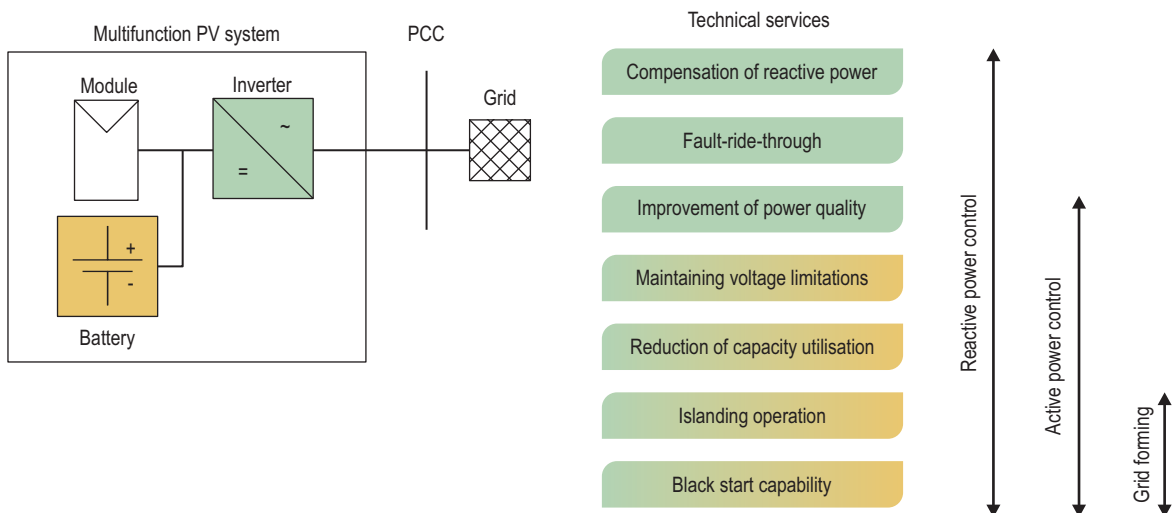

Note: PCC = point of common coupling; this indicates the point of connection to the electric grid.

Source: IEA PVPS (2014), *Transition from Uni-Directional to Bi-Directional Distribution Grids*.

Key point • Solar PV systems can provide a wide range of technical services, some of which require electricity storage.

Accommodating higher amounts of DER requires their impact to be managed at all voltage levels. High levels of DER, while co-located with load at a lower voltage level, still affect dispatch and power flows on the high-voltage network as much as a single-site plant with the same aggregate rating. New modelling tools and greater collaboration between planners at all voltage levels will

be critical for the successful technical management of DER. This calls for a realignment of roles and responsibilities between system operators at different levels.

Smart grid options

ICT and supervisory control and data acquisition (SCADA) systems have been the most important tools for smartening local grids in recent years (IEA, 2015). These technologies increase the observability of the network, i.e. the ability to monitor voltages and power flows along distribution feeders. They also allow for better management of bidirectional energy flows. Dynamic monitoring and control can allow the adjustment of distribution networks in real time in ways that were previously uneconomical or deemed unnecessary (Table 5.1).

Table 5.1 • Overview of different smart grid technology options

DSO resource	Cost/benefit reported as	Role/description	Indicative benefit/cost where positive
SCADA system, improved monitoring and forecasting, upstream flow of information	Smart planning and operation	Improves network observability, hosting on non-dispatchable generation.	1.1-3.3
Automatic network reconfiguration	Smart planning and operation	Increases hosting capacity of local grids, possible reduction of network losses.	1.1-2.2
On-load tap changer	Smart assets	Allows automated voltage regulation by changing transformer winding ratio, either remotely or autonomously.	1.2-1.8
Boost transformer	Smart assets	Stabilises voltage along heavily loaded branch feeders; typically used in long feeders with dispersed consumers to boost the voltage under heavy load conditions.	1.5-2.1
VAR control	Smart assets	With more DER changing active/reactive power balance, fast-acting power electronic devices, such as static VAR compensators (SVC) can stabilise local grid; mitigates voltage rises and/or compensates reactive power by injection of reactive currents.	1.1-1.9
Conservation voltage reduction	Smart assets	ICT solutions that enable local grid feeders to be operated at the lower end of the voltage range as required for system reliability.	1.1-2.6
Local storage	Storage	At local grid level, storage provides peak shaving, load levelling, power quality services, black-start capability and islanding support	1.1-2.4

Notes: VAR = volt-ampere reactive, also known as “reactive power”.

Source: IEA (2016d), *Energy Technology Perspectives 2016*.

Key point • A range of smart grid options are available, often with a favourable cost-benefit ratio.

Advanced modelling capabilities

Historically, local grid planning followed a deterministic process aimed at identifying when and where peak load would occur. Rising levels of DER introduce new uncertainties, as these technologies bring a more complex supply/demand pattern to the grid, and events that determine the necessary size of the grid may not coincide with peak electricity demand. Planning standards will need to be updated using refined network architecture models, which also include innovative mitigation options such as demand-side response measures or the various smart grid options highlighted in the previous section.

System operators and planners of local grids are increasingly relying on modelling tools that have usually been applied only at transmission level. This includes high-resolution representation of

distributed generation resources, new approaches to demand forecasting that account for both controllable and non-controllable loads, and the inclusion of multiple types of end-user load profiles, such as a home with an EV. Such advanced modelling is also critical to effectively managing sector coupling. An integrated approach, whereby EV manufacturers are directly involved in the design of network planning rules, may enhance efforts to develop common standards and protocols. It may also increase the likelihood that supporting grid technologies and DER capabilities evolve in line with the needs of the power system (PlangridEV, 2016).

Ensuring economic efficiency and social fairness through compensation mechanism and retail rate design

Historically, retail electricity pricing was developed on the assumption that customers did not have any alternative to grid supply. Moreover, it was assumed that electricity demand was relatively inelastic, in particular in the short term, with customer consumption reducing only modestly in response to rising prices. In this context, primarily volumetric price recovery was applied, whereby a single per-kilowatt hour (kWh) tariff charge was designed to recover most or all network and energy costs, including the supplier margin and energy taxes. The inclusion in the volumetric retail price of certain cost elements that do not scale directly on a per-kWh basis, such as network reinforcement costs, was justified by the assumption that users with the highest consumption had the largest impact on overall system costs.

With a few noteworthy exceptions (see Box 5.2), in most power systems the application of more sophisticated price schemes has historically been restricted to a limited set of customers with large amounts of load, such as industrial sites. Power system assets have been designed to manage expected variability in load, and the costs and operational complexities of making demand more flexible were deemed too high.

Box 5.2 • Application of time-dependent pricing in France

Before the market unbundling of the 1990s split activities into generation, transmission and distribution, French national utility Électricité de France (EdF) pioneered the use of different forms of variable pricing for residential customers. In the 1980s, EdF introduced a power-line communication system (PULSADIS system), which allowed it direct communication with customer-sited electricity meters, so that electric water heaters and other appliances would be activated at specific times of the day. In addition, a critical peak pricing scheme introduced in the early 1980s allowed customers to lower their electricity prices, if they accepted that they would face significant price hikes for up to 18 days each year (*effacement de jour de pointe*). By the year 2000, these schemes combined to enable 6.5 GW of demand response across France.

Source: Veyrenc, T. (2013), “L’intégration de la demand response sur les marchés d’électricité” [The integration of demand response in electricity markets], www.ceem-dauphine.org/agenda/en/aedbc6064d31e68a7d33b39464f72b7e22bdb117.

The need for a new retail rate design

Driven largely by the many changes described in this report, reforms in retail rate design are being pursued in many jurisdictions (IEA, 2016e). At the same time, advances in IT have lowered the transaction cost of communicating prices for energy and other utilities more dynamically, which opens opportunities for introducing more cost-reflective pricing structures with higher levels of granularity.

A growing number of end users now have an alternative to grid supply, and they use retail tariffs as a reference to make investment decisions. As the cost of DER continues to decline, uptake will

continue to rise. This could become even more relevant in the coming decades if solar PV becomes integrated into building materials, further lowering the additional cost of new installations that coincide with the construction or renovation of buildings.

Increases in distributed solar PV tend to lead to higher levels of self-consumption, and thus lower network flows and, in the absence of tariff reform, associated revenues for the grid owner. Over time, this could translate into higher per-kWh prices for grid consumption for those who do not adopt DER, as the burden of network cost recovery is divided over a shrinking group of customers.²⁴

At low penetrations, this effect is likely to have marginal impact on retail prices (LBNL, 2017). As DER uptake continues, however, this situation raises questions about distributional fairness among different end users, and may lead to a spiralling uptake of DER as ongoing grid supply price increases continue to improve the economics of self-supply.

In addition, sector coupling will link economic signals from other sectors with those of the electricity sector, and make it possible to meet a certain energy service using various sources. This increases the need for a level playing field between the different resources, whereby energy services are priced similarly, and are subject to similar taxes and levies.

Finally, DER may provide system services that are not captured at all in current tariff design. This creates a need not only to consider reform of retail tariffs, but also of valuation frameworks for DER more broadly. Both aspects will be discussed in turn.

Degrees of granularity for retail tariffs

As DER generation options become cheaper, retail prices should be designed to provide fair and appropriate incentives to both network users and DER (IEA, 2016e). With modern IT systems and emerging valuation methodologies, it becomes possible to calculate in greater detail the actual value of a given kWh of electricity consumption at a specific time and place. The deployment of smart meters makes it possible to communicate this value to end users and use data measurements at more regular intervals to apply them in the billing process. Price signals that accurately capture the impact on overall system cost give a stronger incentive for demand shaping when and where this is most valuable to the power system.

Retail prices can be refined along three dimensions (Figure 5.6). First, to indicate the supply-demand balance throughout the day, tariff design may move from a single, flat tariff to various degrees of time-dependency. Real-time pricing, the most advanced form of time-based pricing, has been applied in Spain since 2014, although consumers can opt out and subscribe to other supplier or contract structures (IEA, 2016e).

In addition, demand charges can reflect the contribution of an individual customer to overall generation and network costs. The precise characteristics of electricity consumption, such as the timing and magnitude of peak electricity demand, will influence the timing and location of grid planning and reinforcement.

The third dimension relates to the geographical location of consumption. The cost of delivering power to end users depends on transmission and distribution losses, and on the occurrence of congestion and voltage-related network constraints (MIT, 2016). The options for translating this spatial cost granularity in electricity prices range from regional tariff differences to more precise,

²⁴ It is important to note that the full benefits of distributed solar PV resources are often not realised for many years. While distributed solar PV may lead to immediate-term utility revenue losses, short-term rate increases may be followed by longer-term decreases (resulting from, inter alia, deferred or avoided investment costs). Thus, it is important to consider the impact of these resources from both a short-term and long-term perspective.

real-time calculations of locational marginal pricing that reflect how a customer is situated relative to the various grid nodes.

Figure 5.6 • Options for retail pricing at different levels of granularity

	Granularity				
Time - Energy	Flat tariff	Seasonal time-of-use (summer/winter)	Daily time-of-use (weekday/weekend)	Intra-daily time-of-use (peak/off-peak hours)	Real-time pricing
Time - Demand	No demand charge	Customer peak	Expected system coincident peak, annual	Expected system coincident peak, monthly	Real-time coincident peak
Location	Single price	Zonal disaggregation	Nodal disaggregation	Locational marginal price (LMP)+Txlosses	LMP +Tx/Dx losses

Notes: Tx = transmission; Dx = distribution; LMP = locational marginal price.

Key point • Retail electricity prices can be refined along three main dimensions.

Compensating DER

The methodology for compensating DER, in particular distributed generation, is a strong driver for uptake of these technologies. Setting the right level and structure of remuneration for grid injection is a complex undertaking with important implications. If set too high, a disproportionate amount of money will flow to DER owners; if too low, compensation might be unfair to DER owners. Fixed remuneration (per unit of energy) provides investment certainty, whereas variable pricing can more effectively encourage system-friendly VRE design choices that maximise self-consumption or production during certain hours of higher system demand.

Traditional compensation mechanisms, such as net energy metering, were designed on the supposition that the grid can act as a buffer for the differences in timing of electricity production and consumption of individual households. Household production and consumption are brought together on the final electricity bill. Under net energy metering, localised electricity production is implicitly valued at the rate of the variable component of the retail tariff, as the household can bank production both within and between billing periods (IEA, 2016e).²⁵ Net billing applies a similar method, whereby injected surplus electricity is deducted from the electricity bill at a predetermined rate. In jurisdictions where a large proportion of retail tariffs consists of volumetric rates, net energy metering has come under pressure as DER owners are able to disproportionately offset their contribution to network cost. A third compensation mechanism for DERs is the feed-in tariff. In this arrangement, all electricity injected into the grid is compensated at an administratively determined rate.

As pointed out in Chapter 2, many jurisdictions are shifting to other, value-based compensation for decentralised generation. Methods for such value-based compensation for DER generally fall into two categories. The first category involves taking a snapshot of current DER value, and then providing a long-term compensation guarantee based on that.

A value of solar (VoS) tariff assigns fixed price tariffs based on an assessment of value components, including energy services, grid support and fuel price hedging, among others (Figure 5.7). Minnesota became the first US state to adopt a VoS tariff, with a 25-year inflation-indexed

²⁵ Under net energy metering, banked kWh credits may eventually expire. When this occurs, they are deemed “net excess generation” and are typically credited to the customer at a predetermined rate, usually set between the avoided utility wholesale energy cost and the retail electricity rate.

tariff that was determined through benefit-cost analysis and an extensive stakeholder consultation process (Farrell, 2014).

The second category of value-based DER compensation involves more granular DER tariffs that reflect market conditions at specific times and locations. Adding price variability based on time and location can contribute to lower system costs by sending appropriate price signals to DER customers.

Figure 5.7 • Value components of local generation

Energy services	Avoided capacity	Grid Support	Financial	Additional benefits
<ul style="list-style-type: none"> ■ Energy ■ Transmission and distribution losses 	<ul style="list-style-type: none"> ■ Generation ■ Transmission and distribution 	<ul style="list-style-type: none"> ■ Reactive power ■ Voltage control ■ Frequency support ■ Operating reserves 	<ul style="list-style-type: none"> ■ Fuel price hedge ■ Market price 	<ul style="list-style-type: none"> ■ Grid security ■ Environmental/carbon emissions ■ Socio-economic development

Note: Depending on deployment scenario, the value components may be negative. For example, if deployment of distributed solar PV leads to grid upgrade requirements, it would contribute to increasing rather than decreasing capacity costs.

Key point • Accurately rewarding DER requires a detailed analysis of the various value components.

Implications for policy design

Recognising temporal and spatial value in the pricing of electricity supply and demand can foster greater flexibility and lower the cost of planning and operating a power system. When implementing more efficient short-run pricing, however, it is important to consider the trade-offs that determine the effectiveness of any new tariff design.

First and foremost, regulatory design needs to balance the costs and benefits of higher granularity. Computation and implementation are the primary cost drivers when adopting higher price granularity. Whereas the pass-through of wholesale prices or LMPs calculated at the interface with high-voltage networks can be achieved by a rollout of advanced metering equipment, the use of more precise LMPs requires additional time and resources as considerable ICT capabilities are needed to verify cost calculations (MIT, 2016).

Moreover, customers, regulators and third parties all benefit from simplicity. If consumers are to adapt their behaviour in line with system needs, they must understand the applicable tariff. In most cases, the effectiveness of time-based price differentiation is likely to be more effective than locational price differentiation; consumers can adjust their consumption throughout the day, but typically have little means to compensate for their location in the electricity network.

The same goes for the granularity of DER compensation, which comes at the cost of advanced metering and billing systems, and can muddle the value proposition for risk-averse DER customers that do not understand energy market dynamics. In Germany, virtual power plants are used to aggregate many DER systems and sell their cumulative excess power in real-time electricity markets. This improves the overall responsiveness of small-scale DER to market signals, as more of the available flexibility is used. At the same time, the balancing responsibility is shifted away from individual DER customers to aggregators who can better manage this risk on the basis of a portfolio of DER clients.

Regulators also benefit from simplicity, both in the initial rollout of new rules and also in the ability to change them as they learn about the effectiveness of the rules.

Accurate pricing of both supply and consumption will steer operational and investment decisions in the direction that best matches the evolution of local grids. At some point, however, a more

comprehensive overhaul of the governance structure will also be needed to enable successful power system transformation across all sectors.

Revisiting roles and responsibilities

Page | 92

The fundamental changes being observed in local grids call for a more systematic revision of the historic institutional structure. The reliable operation of local grids today requires enhanced co-operation between grid operators across voltage levels, on issues including grid congestion management, real-time grid monitoring, prioritisation of operational decision making, balancing and operating reserves, voltage support and improved co-ordination in case of unforeseen system events (ISGAN, 2014).

The interface between the transmission system and local grids is a good example of this. Historically, this interface was managed in a clear, top-down fashion. Today, this is no longer fully the case (Figure 5.8). For example, TSOs in Germany rely on aggregators of small-scale dispatchable generators, connected at the local grid level, to obtain operating reserves. If the TSO issues a request for plants to increase output, additional generation will need to be fed in at higher voltage levels to take effect. However, this may not be possible if congestion is being experienced at the local grid level at that moment. This point highlights the need for clear rules and responsibilities under the new paradigm.

Figure 5.8 • Changes at the interface between transmission and local grids

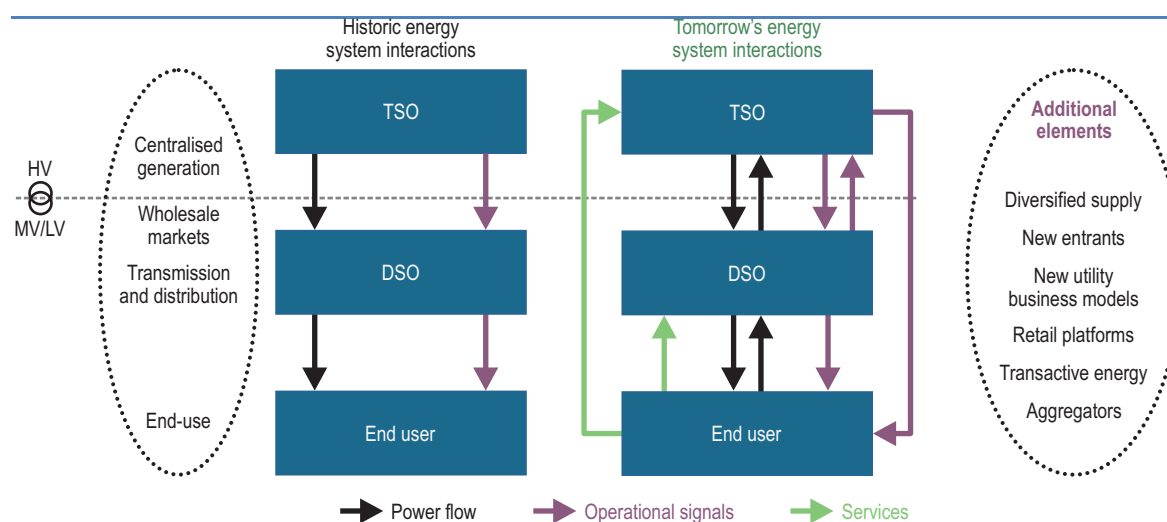

Notes: HV = high voltage; LV = low voltage; MV = medium voltage.

Source: Adapted from Birk et al. (2016), "TSO/DSO coordination in a context of distributed energy resource penetration".

Key point • More complex energy flows and operational signals require new forms of co-ordination.

Other institutional reforms are needed to accommodate new commercial relations. The uptake of DER and intelligent appliances allows the end user to actively partake in the provision of energy and system services. New parties, for example aggregators or smart solution providers, enter the market to engage with the end customer in previously non-existent commercial arrangements. This may lead to inconsistencies, such as when suppliers and aggregators compete for end-user consumption. To allow for effective competition, the French regulator has ensured that aggregators have free, confidential access to consumers so that they can operate independently of suppliers, without requiring any authorisation from the supplier to operate (Veyrenc, 2016).

Elements of structural reform

Regulators and policy makers are beginning to grapple with the challenge of capturing the various changes happening in local grids and setting up institutional structures that are fit for purpose. Many stakeholders – from grid operators to aggregators – are arguing that the changing needs and technical possibilities of local grids require the identification and assigning of new roles. Often, however, they do not agree on what form the preferred new arrangements should take.

For example, digitalization introduces a new role into the structure of electricity markets, related to the ownership and management of data. The creation of a forum for data exchange represents a key challenge for successful power system transformation. If the ownership and management of data flows are centralised, one party would be designated to ensure the provision of a safe depository for metered customer data and data on network operations and constraints. This party ensures that eligible third parties enjoy non-discriminatory access to this data, and facilitates communication of information to end customers about their energy use and production (MIT, 2016). The assignment of this vital task in future power systems will be a key decision for policy makers in the process of power system transformation. In Denmark, the TSO (Energinet.dk) was designated this role, whereas in the United Kingdom and Australia, an accredited third party is responsible for data management. An alternative, decentralised solution could circumvent the need for a single “data hub operator” and instead rely on a network of computers to secure and verify data flows and transactions.

Many reform initiatives focus on evolution of the role of local grid companies. In the European context, regulatory reforms aim to transform local grid operators into neutral facilitators of electricity markets at the local grid level, where DER can offer energy and system services on a level playing field (EC, 2017). A similar approach is being taken as part of the “Reforming the Energy Vision” process in the state of New York. Integrating a revised institutional structure for local grids into an overall governance framework for the energy system remains a field of active research (Table 5.2).

Table 5.2 • Changing governance framework for local grids

	Role	Priorities	Regulation
Local system operator	Energy supply Operational standards	Maximise asset infrastructure	Rate of return Minor incentive regulation
Distribution service provider	Integrate all DER, reveal value Data provision	Optimise asset infrastructure	Performance-based

Source: Adapted from IGov (2016), “Distribution Service Providers (DSP): a transformative energy system institution?”.

Key point • The evolving role of local system operators will need to be reflected in updated governance frameworks.

The scope and depth of such institutional reconfigurations are substantial. The interdependent nature of various elements of reform implies that delays in one area may reverberate throughout the overall transformation process. Indeed, rates of progress on various reform programmes demonstrate the difficulty of aligning the interests of a wide number of stakeholders, while also supporting grid operators and utilities as they evolve towards their projected new roles in future energy systems.

Nonetheless, the rationale for power system transformation in local grids remains. In a process of continuous learning, policy and market reform will continue to unlock the potential of intelligent technologies, innovative business models, and increasingly empowered end users that could well drive the decentralisation of electricity supply.

References

- Birk, M. et al. (2016), "TSO/DSO coordination in a context of distributed energy resource penetration", presentation at EEIC 2016.
- EC (2017), "Proposal for a regulation of the European Parliament and of the Council on the internal market for electricity", COM(2016) 861 final/2, European Commission, Brussels.
- EPRG (2016), "Exploring the market for demand-side response", Energy Policy Research Group, University of Cambridge.
- Farrell, J. (2014), *Minnesota's Value of Solar: Can a Northern State's New Solar Policy Defuse Distributed Generation Battles?*, Institute for Local Self-Reliance, Minneapolis, MN, <https://ilsr.org/wp-content/uploads/2014/04/MN-Value-of-Solar-from-ILSR.pdf> (accessed 7 April 2017).
- IEA (International Energy Agency) (2017), *Global EV Outlook 2017*, OECD/IEA, Paris.
- IEA (2016a), *Medium-Term Renewable Energy Market Report 2016*, OECD/IEA, Paris.
- IEA (2016b), *Global EV Outlook 2016*, OECD/IEA, Paris.
- IEA (2016c), *World Energy Outlook 2016*, OECD/IEA, Paris.
- IEA (2016d), *Energy Technology Perspectives 2016: Towards Sustainable Urban Energy Systems*, OECD/IEA, Paris.
- IEA (2016e), *Re-powering Markets*, OECD/IEA, Paris.
- IEA (2015), *Tracking Clean Energy Progress*, OECD/IEA, Paris.
- IEA PVPS (2014), *Transition for Uni-Directional to Bi-Directional Distribution Grids*, International Energy Agency Photovoltaic Power Systems Programme, OECD/IEA, Paris.
- IGOV (2016), "Distribution Service Providers (DSP): a transformative energy system institution?", presentation, London.
- ISGAN (2016), *Spotlight on Smart and Strong Power T&D Infrastructure*, version 2.0, International Smart Grid Action Network, Paris.
- ISGAN (2014), "TSO-DSO Interaction: An overview of current interaction between transmission and distribution system operators and an assessment of their cooperation in Smart Grids" (discussion paper), International Smart Grid Action Network, Paris.
- LBNL (2017), "Putting the potential rate impacts of distributed solar into context", Lawrence Berkeley National Laboratory, Berkeley.
- MIT (2016), *Utility of the Future*, Massachusetts Institute of Technology Energy Initiative, Cambridge, MA.
- PlanGridEV (2016), "Distribution grid planning and operational principles for EV mass roll-out while enabling DER integration" (final report), February, PlanGridEV, Essen.
- SEDC (2015), "Mapping demand response in Europe today", Smart Energy Demand Coalition, Brussels.
- US DOE (2015), *Data Privacy and the Smart Grid: a Voluntary Code of Conduct*, US Department of Energy, www.energy.gov/sites/prod/files/2015/01/f19/VCC%20Concepts%20and%20Principles%202015_01_08%20FINAL.pdf (accessed 7 April 2017).

Veyrenc, T. (2016), “Demand-response, flexibility and smart grid planning: Status and discussions in France”, workshop presentation, Paris.

Veyrenc, T. (2013), L’intégration de la demand response sur les marchés d’électricité [The integration of demand response in electricity markets], presentation, October, Paris, www.ceem-dauphine.org/agenda/en/aedbc6064d31e68a7d33b39464f72b7e22bdb117 (accessed 6 March 2017).

Chapter 6. Power system transformation assessment framework and case studies

This chapter presents four case studies that illustrate the status and progress of power system transformation in contrasting contexts, using an assessment framework that analyses different aspects of the transformation process. This assessment framework has been designed by taking into consideration the trends and associated issues highlighted in the previous chapters.

Four countries were selected: Indonesia, South Africa, Mexico and Australia. They are presented in this order to represent the relative development of the power sector structure in each country. These countries provide diversity for the analysis due to their social, economic and geographical contrasts. Indonesia, South Africa and Mexico are considered to be dynamic power systems, since a large amount of additional investment in power system infrastructure is required to meet growing demand. Australia, by contrast, is a stable power system where electricity demand growth has been stagnating for several years.

Each of these countries is unique in their electricity sector structure, levels of variable renewable energy (VRE) deployment, uptake of new technologies, and regulatory and market frameworks. Using the assessment framework, key attributes and options for each of four system aspects are also summarised.

Framework for assessing power system transformation

The qualitative assessment framework is used to analyse the case studies based on four main aspects that are pertinent to power system transformation: markets and operations, planning and infrastructure, uptake of innovative technologies, and efficiency and sector coupling (Table 6.1). Each of these four aspects has been further subdivided, and criteria for assessing each subaspect identified. Note that certain subaspects may not be applicable to all countries due to the structure of the electricity sector. For example, market frameworks for improving flexibility may not be applicable to jurisdictions under a vertically integrated utility structure.

Markets and operations

This aspect is related to the structure of the electricity sector and the way in which it is operated at both the wholesale and retail levels. It is further categorised into wholesale and retail levels.

For the wholesale level subaspect, it focuses on improved bulk power system operation, which encompasses technological options and practices put in place by system operators to manage the power system in different timescales. In addition, this subaspect covers market frameworks and regulations for improving system flexibility.

For the retail subaspect, the focus is on improved operation and planning of medium- and low-voltage grids managed by distribution network operators. Also playing an important role are retail tariff structures that influence consumer behaviour, which help to activate and engage demand response as a contribution to the system.

Planning and infrastructure development

This aspect encompasses the architecture of the power generation, transmission and distribution networks. It is further categorised into integrated planning frameworks and electricity grids.

The integrated planning frameworks subaspect relates to the adoption of integrated approaches to electricity sector planning, which take into consideration different system elements, sometimes across sectors, in a holistic way, also considering their interdependencies.

The electricity grids subaspect addresses grid expansion, which can facilitate the efficient transformation of the power system while maintaining affordability and reliability. A critical element is to take VRE into consideration in grid expansion.

Uptake of innovative technology

This aspect looks at an array of emerging innovative technologies on the supply and demand sides, including smart technologies, flexible resources and resource-efficient technologies. These can facilitate a more flexible, reliable and affordable power system.

The smart technologies subaspect relates to a smarter future electricity system that encompasses digitalization of the energy system, data gathering and system elements to enable real-time visibility.

The flexible resources subaspect covers storage technologies and demand response, both of which can be used to smooth variability in VRE generation.

The resource-efficient technologies subaspect relates to system-friendly VRE deployment that minimises overall system costs. This is not only restricted to specific technologies – it also encompasses strategic location, technological mix and technical capabilities of the power plants.

Efficiency and sector coupling

This aspect relates to developments that change the way electricity is sourced and used. It covers electrification of non-electricity sectors, particularly the transport and heating and cooling sectors, and energy efficiency.

The electrification of the transport and heating and cooling sectors can be managed in such a way that it complements the output of VRE generation and therefore compounds the benefits of clean-energy deployment.

For the energy efficiency aspect, improving energy efficiency across the power sector can help reduce costs both at the system and customer level. In addition, integrating energy efficiency with other electricity-related policies holds out the prospect of great benefits.

Table 6.1 • Dimensions and criteria for applying the assessment framework

Aspect	Subaspects	Criteria	Explanation
Markets and operations	Wholesale level	<ul style="list-style-type: none"> Improved bulk power system operations Market frameworks for improving flexibility 	<ul style="list-style-type: none"> Bulk system operations are the set of practices put in place by the system operator to manage the power system and the transmission network in different timescales (years to real time). In systems characterised by the presence of a competitive energy market, the market framework is the set of rules and regulations prescribing market participants' conduct and actions.
	Retail level	<ul style="list-style-type: none"> Improved local grid operations Market framework for improving flexibility 	<ul style="list-style-type: none"> Local grid operators manage the distribution networks following a set of rules and accepted procedures. The energy authority and energy retailers design the retail tariff structure, influencing consumer behaviour.
Planning and infrastructure	Integrated planning frameworks	<ul style="list-style-type: none"> Integrated approach to power system planning 	<ul style="list-style-type: none"> The future architecture of the power system is usually anticipated by planning, which is a policy measure to shape new system arrangements. An integrated approach takes into consideration system elements in a holistic way, considering their interdependencies.
	Electricity grids	<ul style="list-style-type: none"> Grid expansion anticipating power system transformation 	<ul style="list-style-type: none"> Grid expansion is usually planned up to ten years advance. The (actual or expected) presence of VRE can greatly influence planning decisions. Anticipating the presence of VRE can provide system benefits.
Uptake of innovative technology	Smart technologies	<ul style="list-style-type: none"> Adoption of smart technologies 	<ul style="list-style-type: none"> Digitalization of the energy system, data gathering and system elements to allow real-time visibility are principal aspects of a future power system. System operation and demand-side management are enhanced by these means.
	Flexible resources	<ul style="list-style-type: none"> Electric storage Innovative demand response 	<ul style="list-style-type: none"> Electric storage technologies can absorb electricity and return it at a later stage. They can be used to smooth VRE variability. Demand response encompasses all the technologies and measures to make demand more reactive to energy prices. They can be used to avoid/smooth peak net demand.
	Resource-efficient technologies	<ul style="list-style-type: none"> Flexible power plants: system-friendly VRE 	<ul style="list-style-type: none"> System-friendly VRE deployment minimises overall system costs. It encompasses the strategic location, technology mix and technical capabilities of the power plants.
Efficiency and sector coupling	Electrification of the transport sector	<ul style="list-style-type: none"> Cross-sectoral integration 	<ul style="list-style-type: none"> Electrification of demand is a cost-effective option to mould demand to follow VRE generation profiles.
	Electrification of the heating sector		
	Energy efficiency	<ul style="list-style-type: none"> Consistency of energy efficiency policies with VRE expansions plans 	<ul style="list-style-type: none"> Energy efficiency policies can be linked to renewables targets, to reap benefits from the alliance of these measures.

Indonesia

General overview of Indonesia's power sector

The structure of the Indonesian power sector is vertically integrated with private participation in generation. PT Perusahaan Listrik Negara (PLN), the Indonesian government-owned public electricity utility, is responsible for generation, network ownership and operation, as well as supply. In 2002, according to the Law No. 20/2002, power sector reform was passed with a view to full liberalisation of the sector. However, the Indonesian Constitutional Court revoked the law in 2004. Currently only the generation sector is partially liberalised. System operations, transmission, distribution and sales of energy are monopolised by PLN, although, according to the new Law No. 30/2009, private companies and provincial governments through provincially owned companies are allowed to provide electricity services to remote areas that are not served by PLN.

However, PLN has first priority and, in the case of no other party being able to provide electricity services, PLN is assigned to develop and provide the service.

Over the past decade, power generation in Indonesia has shifted away from oil to the utilisation of domestic coal resources and natural gas (Figure 6.1). The majority of generation is provided by small thermal plants of less than 200 MW per unit (IEA, 2015a).

Figure 6.1 • Electricity generation by fuel type, 2004-14, Indonesia

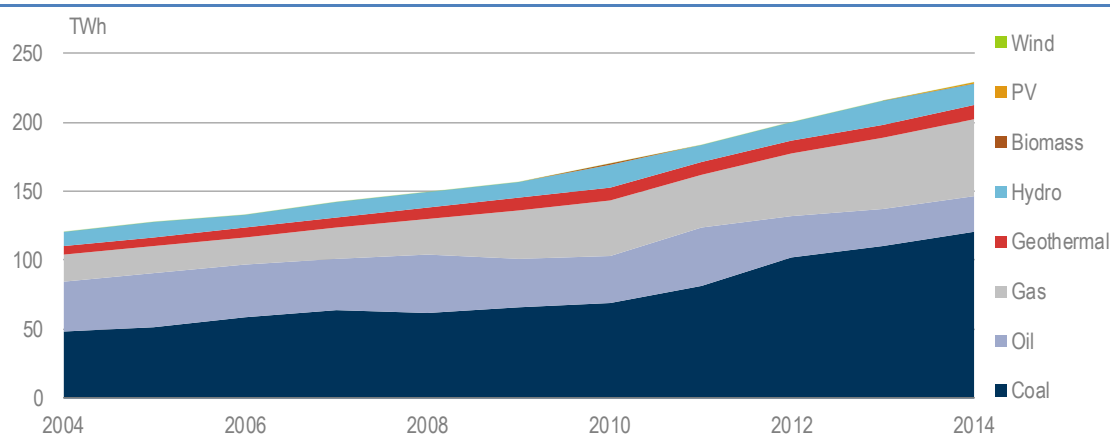

Source: IEA (2017a), *World Energy Statistics 2016*.

Key point • Electricity generation has increased steadily in the past decade. VRE generation is almost non-existent in Indonesia.

According to the latest Indonesia Electricity Supply Plan (RUPTL), generation capacity is expected to increase by 45% over the next 10 years. In the plan, coal will continue to play a major role in the power sector. The private sector will account for 57% of total new capacity (PLN, 2016a).

Due to its archipelagic layout, the electricity network in Indonesia consists of many separated heterogeneous subsystems. Some rural areas have low electrification rates. The government plans to attain 100% electrification by 2020 (from the 91% electrification rate in 2016) (Anditya, 2017). Additionally, the Indonesian power system is in need of new generation capacity, as it struggles to meet growing power demand. An increase in VRE production could alleviate current shortages and provide power solutions for remote island systems. The potential is sizeable, given

the country's solar resources and the fact that modern wind turbines can now generate cost-effectively at resource levels found in more favourable parts of the country.

PLN owns and operates Indonesia's entire transmission grid. This encompassed around 51 500 km of transmission lines and 946 000 km of distribution lines in 2016 (Anditya, 2017). The Indonesian system consists of a wide range of heterogeneous subsystems, which comprise the electricity grids of its islands. With the exception of the Java-Madura-Bali (JAMALI) system, these are not interconnected. With more than 21 000 km of transmission lines and 310 000 km of distribution lines, the bulk of the country's infrastructure is located in the JAMALI system.

The transmission network consists of 8 systems and 600 small isolated grids, which are all operated by PLN (Figure 6.2). With the notable exception of the JAMALI system, islands are not interconnected with each other; this has led to the constitution of local branches of PLN, local grid codes and regulations. The JAMALI system is the largest interconnected grid, representing 77% of total energy consumption. Ministerial Decree Mandate No. 3/2007 of 29 January 2007 defines a set of rules and procedures (grid codes) to underpin the safe operation of the JAMALI power system (IEA, 2016a).

Figure 6.2 • Indonesian major power plants and networks

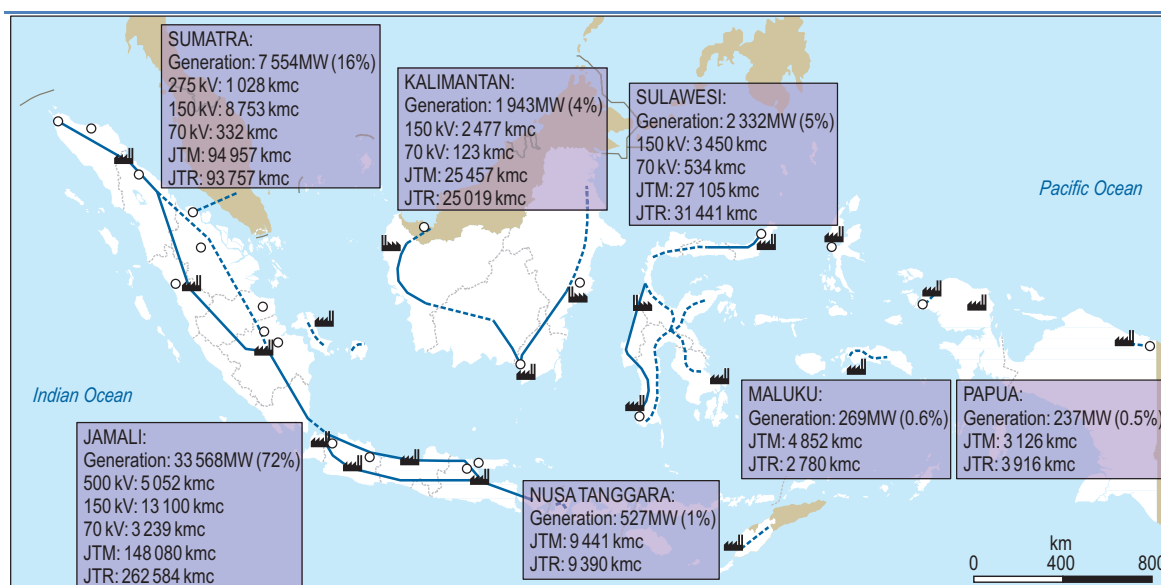

This map is without prejudice to the status of or sovereignty over any territory, to the delimitation of international frontiers and boundaries, and to the name of any territory, city or area.

Notes: kmc = kilometre of circuit; JTM = medium-voltage network; JTR = low-voltage network; generation figures are total installed power plant capacity as of 2014. Transmission and distribution figures are total circuit length as of 2014.

Source: Reprinted from IEA (2015a), *Energy Policies Beyond IEA Countries: Indonesia 2015*.

Key point • Indonesia's transmission system is concentrated on the islands of Java and Sumatra, whereas the many islands function as small isolated systems.

Market and operations

Wholesale level

The scheduling and dispatch code (SDC) section of the grid code sets the procedures for the JAMALI Dispatch Centre. It establishes the least-cost energy mix to meet forecast load, and dispatches power plants according to the merit order.

Power plant scheduling is initially performed on a monthly basis, and then updated weekly to account for maintenance and outages. The final schedule is set day-ahead. All generators must provide PLN with their weekly availability at the weekly planning stage, and confirm this

information by 10:00 on the day before dispatch. In particular, hydropower plant operators have to provide information about reservoir levels and, in case of run-of-the-river hydropower plants, provide a forecast for every hour of the following day. Generators must be able to receive and respond to AGC signals from the Dispatch Centre, which is operated by PLN.

PLN produces a forecast of demand for every half hour of the following day and a daily implementation plan in a way that minimises total variable costs. After stability verification, all network users are informed of the final scheduling before 15:00. The final scheduling contains the expected active power output for each power plant for every half hour (MEMR, 2007).

Indonesia currently has no high-voltage interconnections to neighbouring countries. The grid code defines operating reserves in the JAMALI system. For the purposes of reliability, Indonesia has set a minimum reserve margin of 30% for JAMALI and 40% for the other systems (Anditya, 2017).²⁶ In addition, operating reserve requirements are defined as follows (MEMR, 2007):

- Spinning reserve: the capacity of the largest generating unit in the system (for the JAMALI system, 815 MW).
- Cold backup plus spinning reserve: twice the capacity of the largest generating unit in the system (for the JAMALI system, 1 630 MW).
- Long-term reserve plus cold backup and spinning reserve: twice the capacity of the largest generating unit in the system plus a margin of reliability, calculated as a percentage of daily peak load, based on an analysis of loss-of-load probability.

Various protection schemes are employed in the system for maintaining reliability. These include under-frequency load shedding, over-generation shedding and overload shedding.

The growth in electricity consumption has not been coupled with the construction of a sufficient number of new power plants, and rolling blackouts have become a recurring problem (IEA, 2015a). Tackling this issue from the demand side, via both energy efficiency measures and industrial demand response, would help to reduce the pressure to add generation capacity and could make the system more flexible. Currently, there is no direct budget allocation dedicated to a DSM programme.

As the Indonesian power system will be undergoing major development in order to meet growing demand, it is worth considering the possible future growth of VRE and its impacts.

Retail level

PLN distributes and sells electricity through its subsidiary, PLN Distribution.

Investment in distribution is anticipated to increase in the coming years. This investment relates to development of the distribution system to increase the electrification ratio, improve reliability and accommodate demand growth.

In November 2016, the Ministry of Energy and Mineral Resources (MEMR) issued a decree that will allow private entities to develop small-scale power plants (up to 50 MW) and distribute the energy themselves in the surrounding areas. The law aims to improve the electrification ratio, in particular in small islands.

The JAMALI system has six distribution system operators (DSOs), which are PLN Distribution's proxies. They are in charge of maintenance of the grid, including distribution lines and substations, to provide electricity in their assigned areas. The PLN JAMALI Dispatch Centre can monitor the status of 29 subsystems, which are divided between the DSOs. Given the system's

²⁶ Reserve margin in Indonesia is calculated based on net generation capacity and peak demand.

fast-growing energy demand, the grid is undergoing expansion, with 51 new subsystems to be put in place by 2019.

As stipulated by Electricity Law No. 30/2009, the government of Indonesia is in charge of setting electricity prices (Figure 6.3). Tariffs are set for six consumer types and differentiated by location. They are reviewed regularly and issued monthly.

Figure 6.3 • Average tariffs and total consumption of electricity per sector, Indonesia, 2015

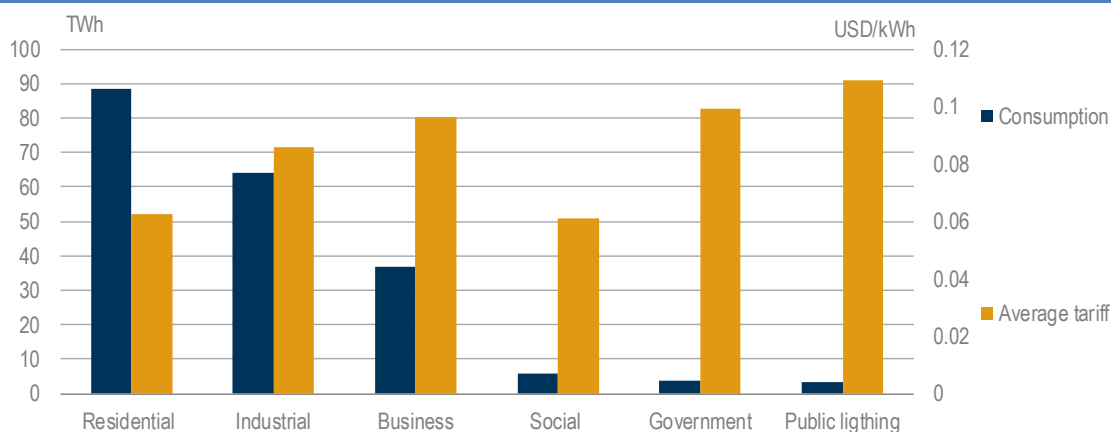

Source: Adapted from PLN (2016b), *Statistik PLN 2015*.

Key point • Indonesia applies a sectoral differentiation of electricity tariffs.

Indonesia subsidises electricity consumption, but the country is reducing subsidies over time; in the last two years, electricity prices have increased as a result of the move to reduce subsidies.

With the exception of larger consumers, tariffs do not reflect the differences in load demand between peak and off-peak periods. Moreover, in 2005 PLN introduced a flat-rate prepaid option, quite popular in the residential and business sectors; in mid-2015, 20.64 million consumers had chosen that option (CNN, 2015). Certain TOU tariffs are imposed on consumers connected to the medium-voltage grid.

Planning and infrastructure development

Integrated planning frameworks

Indonesia has developed ambitious long-term targets for electricity development in its National Energy Policy (NEP), according to which the government plans to expand installed generation capacity to 115 GW by 2025.

The government has identified the following priority areas and goals for power generation development in Indonesia:

- to meet demand growth
- to address the lack of electricity supply in parts of Indonesia
- to increase reserve capacity in order to fulfil a reserve margin of 30% to 40% through the prioritisation of local energy sources
- to avoid oil-fired power generation.

Based on the high-level guidelines set out in the NEP, MEMR has drafted a National Energy Master Plan (RUEN) and a National Electricity Master Plan (RUKN). The RUKN serves as a 20-year guidance document for the future development of power infrastructure, as well as a plan for

investment in and utilisation of renewable energy resources. MEMR updates the RUKN annually. Local governments establish their own local energy and electricity plans that are consistent with the RUEN and RUKN.

Taking into account national and local electricity plans, PLN publishes annually a ten-year electricity power supply business plan, the RUPTL. This plan provides a projection of power demand at national and regional level, and guides PLN's decision making as to which projects to pursue and which independent power producers (IPPs) to sign. The final version of the RUPTL is the result of negotiation between PLN and the relevant ministries regarding the cost and feasibility of power plants. As a result, the RUPTL may not always meet government objectives. The RUPTL for 2016-25 forecasts that demand will increase by an average of 8.6% per year to 2025 (Anditya, 2017; PLN, 2016a).

The RUPTL contains provision for both deployment of the generation fleet and expansion of the transmission grid, allowing the most important system developments to be planned in a holistic way. As Indonesia's power sector is undergoing expansion, PLN could take advantage of its role in planning the power system to accommodate greater VRE generation more easily, following examples of emerging trends in already VRE-rich power systems, including the development of flexibility resources as demand-side management options.

Electricity grid planning

To date, no high-voltage interconnection lines exist between Indonesia and its neighbours. Only marginal amounts of electricity are imported from Malaysia through two 20 kV distribution lines in West Kalimantan. Several transmission projects linking Indonesia to Malaysia are in progress in an effort to strengthen regional interconnection capacity and security of supply (IEA, 2015a, 2015b).

PLN is progressing major projects to increase the meshing of the transmission grids, by connecting different islands or closing open loops. Based on the more recent RUPTL, by 2025 PLN aims to have built additional distribution capacity of more than 67 900 km and additional distribution transformer capacity of 172 000 megavolt amperes (MVA) across Indonesia.

In 2017 the Indonesian government issued a new Presidential Decree 14/2017, with the aim of speeding up the construction of national electricity infrastructure, covering power plants, transmission systems, substations and other supporting facilities.

PLN grid expansion is in line with the forecast additions to generation capacity. Over the next decade, PLN foresees the limited deployment of VRE generation; as such, grid investment does not seek to overcome VRE hotspots or forestall grid congestion. Taking into account the potential of VRE to contribute to the electrification and decarbonisation of the country, in future the RUPTL may highlight different grid expansion priorities (PLN, 2016a).

Uptake of innovative technologies

Smart technologies

PLN is implementing a number of smart grid pilot projects, which focus on the integration of VRE and on energy management and power quality, with the aim of improving energy efficiency, reliability of power supply and reducing CO₂ emissions through increased penetration of renewables. Smart grids could support the development of electricity infrastructure to create a system that is flexible and efficient.

Smart grid technology could assist the country in containing peak demand growth, increasing reliability, reducing transmission and distribution losses, and improving revenue collection. However, any roll-out of such options should be subject to a prior cost-benefit analysis.

Flexible resources

Page | 104

Currently, Indonesia has no DSM schemes in place, and neither is any pumped hydro storage installed. However, the Upper Cisokan pumped storage project is an ongoing project in West Java, with a projected capacity of 1 040 MW. The first generator is expected to be commissioned in 2019. A further facility is under consideration in Central Java, the Matenggeng pumped storage project, with a planned installed capacity of approximately 880 MW.

Unlike the previous version, RUPTL 2016-25 takes into account the impact of DSM programmes, energy efficiency programmes and energy conservation in its demand forecast. PLN observed, in its historical data, that industrial and commercial users tended to suppress or reduce their power consumption when electricity prices increased. Electricity rates are, therefore, considered to exert a significantly greater influence on electricity consumption than other factors, such as environmental awareness. It is possible that peak charges or TOU tariffs may be introduced in the medium or long term in Indonesia, following these recent observations by PLN (PLN, 2016a).

Resource-efficient technologies

In early 2017, MEMR issued a new FIT scheme for renewable energy. The new decree (Ministerial Decree No. 12/2017) set the FIT for all renewable energy technologies (wind, solar PV, hydropower, biomass and geothermal) based on negotiations between IPPs and PLN, except for VRE technologies. PLN must issue tenders for VRE technologies based on a quota, in accordance with the local electricity supply plans. PV systems must also have a minimum size of 15 MW, which may make them unsuitable for small islands systems.

The maximum FIT levels are the same for all technologies and are indexed to the local PLN energy production cost (EPC). Currently the JAMALI system has the lowest EPC, at around USD 0.06 per kilowatt hour (kWh) (IDR 800/kWh), while in Papua the EPC is around USD 0.19/kWh (IDR 2 500/kWh). The national average EPC is USD 0.105/kWh (IDR 1 400/kWh). The focus of the regulation is to lower PLN's generation costs while integrating renewable energy (DLA, 2017).

The decree stipulates that if the local EPC in the project region is lower than the national average, the maximum FIT allowed will be equal to the local EPC. On the contrary, if the local EPC is higher than the national average, the maximum FIT allowed will be equal to 85% of the local EPC. As a result, eastern Indonesian islands will have higher FIT levels, since their EPCs are currently higher than the national average. The system guarantees higher tariffs for areas where the energy is in greater need, reflecting the locational value.

The regulation includes priority of dispatch of renewable energy plants with a size up to 10 MW, which are treated as must-run. PPA terms may include take-or-pay clauses. Domestic PV systems are not backed either by support schemes or dedicated grid codes.

Efficiency and sector coupling

Although Indonesia has made considerable regulatory progress on energy efficiency measures in recent years, further progress is hindered by several different ministries having duties and responsibilities for energy efficiency that are key to implementing standards and promoting financial support. In addition to the Directorate of Energy Conservation within MEMR, these include the Ministry of Industry, the Ministry of Transport, the Ministry of National Development Planning, and the Ministry of Finance, among several others, meaning that strong co-ordination is

needed to develop, implement and monitor regulatory measures. At present, co-ordination within and between ministries could be improved. The establishment of a single implementation authority would prove helpful for improving implementation of energy efficiency measures in Indonesia.

Indonesia's government has set ambitious goals to reduce energy consumption by 17% by 2025, compared to business as usual, through the implementation of energy efficiency measures across the economy. Strengthening current policies and implementing additional ones will be essential to meeting the target.

Important regulations in support of energy conservation and efficiency have helped to build a foundation for improved energy management across energy-related sectors in Indonesia. For example, energy labelling of appliances has started and there are signs of a nascent energy services contracting sector. Nonetheless, general awareness of the benefits of energy efficiency and conservation measures seems low. In general, a greater focus on energy supply than on energy demand issues is apparent, although this is often the case in many countries.

The principal obstacle to energy efficiency and conservation policies in Indonesia is the subsidy of fossil fuels and electricity. The ongoing increase in tariffs and fuel prices through subsidy reform should be helpful in curbing the growing demand for energy, while not necessarily impeding economic growth. Energy efficiency is central to these ambitions and should be placed higher on the energy agenda, especially since investments in supply and transformation are coming online at a slower pace than government projections of energy demand. Other barriers include low public and professional awareness of the benefits of energy efficiency measures, and limited experience in financial institutions and public procurement (IEA, 2015b).

Summary and main observations

Table 6.2 • Key attributes and options for Indonesia

Market and operations
Wholesale level
Power plant scheduling is performed on a monthly, weekly and daily basis. PLN produces a generation schedule for each power plant on a half-hourly basis for the following day taking into account demand forecast. Power plants are dispatched in real time via AGC. Grid codes exist in the larger systems, including JAMALI, Sumatera, Sulawesi and Kalimantan. Spinning reserves are determined based on deterministic approaches (i.e. loss of largest units). The grid code in the JAMALI system was last revised in 2007 and therefore revisions could play a key role in enhancing the reliability of the system. Given the possible future growth of VRE, it is also worth considering including specific requirements for VRE plants in grid codes. Current grid codes do not account for VRE.
Retail level
There have been a number of developments at retail level. Private entities have recently been allowed to develop small-scale power plants and to distribute electricity directly in the surrounding areas in order to improve electrification in small islands. Tariffs are set for six consumer types and differentiated by location, and are reviewed regularly. Except for large customers, TOU tariffs are currently not applied in Indonesia. Local grid operation is carried out by DSOs. Co-ordination takes place between DSOs and the TSO in the form data exchange and communication. Indonesia subsidises electricity consumption, but the subsidies have been reduced over time. Peak charges or time-dependent tariffs represent an option for Indonesia, since they have proven to be a viable way to smooth demand, reducing the risk of load shedding. As the grid is undergoing expansion, with many new sub-systems, it is important to maintain the level of co-ordination between DSOs and the TSO.
Planning and infrastructure development
Integrated planning frameworks
PLN publishes its electricity power supply business plan (RUPTL) on an annual basis, providing a ten-year outlook to guide PLN's decision making in electricity sector investment. It covers load forecasts, generation capacity expansion and transmission and distribution grid developments. Although it appears that the RUPTL has taken into account the National Energy Master Plan (RUEN) and the National Electricity Master Plan (RUKN), they appear to be loosely integrated. Renewable energy targets are set under the RUEN but it contains no energy efficiency targets, which could have an impact

on electricity demand forecasts. Local governments establish their own local energy and electricity plans that are consistent with the RUEN and RUKN.

Electricity planning in Indonesia could benefit from placing greater emphasis on the demand side, which would lead to an efficient use of resource and lower overall system costs.

Electricity grids

The subgrids in Indonesia are not connected due to the country's geographical nature. The bulk of the country's electricity infrastructure is located in the JAMALI system. Indonesia has no high-voltage cross-border interconnections with neighbouring countries. Several transmission projects linking Indonesia to Malaysia are in progress to strengthen regional interconnection capacity. A number of transmission projects have been planned with the aim of speeding up the provision of electricity infrastructure and to strengthen the network within each subgrid and connections between different islands.

Grid expansion planning does not take into account future VRE deployment. Given short project lead times, modularity and resource availability, solar PV may boost the generation capacity in the country; grid expansion plans could anticipate future congestion and hotspots by considering the potential for dedicated areas for this technology.

Uptake of innovative technology

Smart technologies

Smart grid projects are currently being implemented by PLN under pilot projects. The Smart Grid Roadmap has been established in Indonesia with the aim of improving energy efficiency, reliability and increased penetration of renewables. This roadmap could support the development of electricity infrastructure to create an electricity system that is flexible and efficient.

The government may create policies to support private-sector deployment of these technologies, also for the purposes of increasing electrification.

Flexible resources

DSM programmes are absent in Indonesia. The first pumped storage project, with a capacity of 1 040 MW, is expected to be commissioned in 2019 and will provide additional flexibility to the system.

Since a lack of generation capacity during periods of peak demand is a recurring issue, DSM options have the potential to address this challenge. DSM can be a cost-effective option that can be implemented rather quickly compared to the commissioning of new power plants. One example is load management agreements with larger consumers, which ease the burden on the grid during peak demand periods.

Resource-efficient technologies

A new FIT scheme for renewable energy has recently been put in place, which will result in the eastern part of Indonesia receiving higher FIT levels than the national average. This scheme guarantees higher tariffs for areas with greater energy need, reflecting the locational value. This policy appears to reflect the system value of VRE in a way that may have higher costs, but which may bring more benefits to the entire system.

However, caution must be taken as this may also lead to highly concentrated deployment of renewable energy in the east, causing operational challenges on the grid. This issue needs to be taken into account in power system planning.

Efficiency and sector coupling

Indonesia has ambitious energy efficiency targets, which include objectives for reducing final electricity consumption. Energy efficiency regulations have helped to build a foundation for energy management across energy-related sectors in Indonesia. These regulations include, for example, energy labelling of appliances and standards for buildings envelopes.

Nonetheless, general awareness of the benefits of energy efficiency and conservation measures seems to be low. The focus appears to be on energy supply rather than on the demand side. A further obstacle to energy conservation policies in Indonesia is the subsidies on fossil fuels and electricity. An increase in tariffs and fuel prices through subsidy reform could play a role in increasing energy efficiency.

South Africa

General overview of South Africa's power sector

Eskom, South Africa's vertically integrated and state-owned power utility, currently supplies about 95% of the country's electricity with an installed capacity of around 45 GW. More than 90% of electricity is generated by coal plants (Figure 6.4), which receive their feedstock from abundant coal deposits near Johannesburg, where most plants are located. The Koeberg nuclear power station (1 800 MW) is located north of Cape Town. Four open-cycle gas turbine (OCGT) stations, with a total capacity of 2.4 GW, function as peaking plants (IEA, 2016a). In addition, Eskom manages a small number of wind, concentrating solar power and hydro projects. The remaining 5% stems from imports and IPPs.

Figure 6.4 • Electricity generation by fuel type and VRE share, 2004-14, South Africa

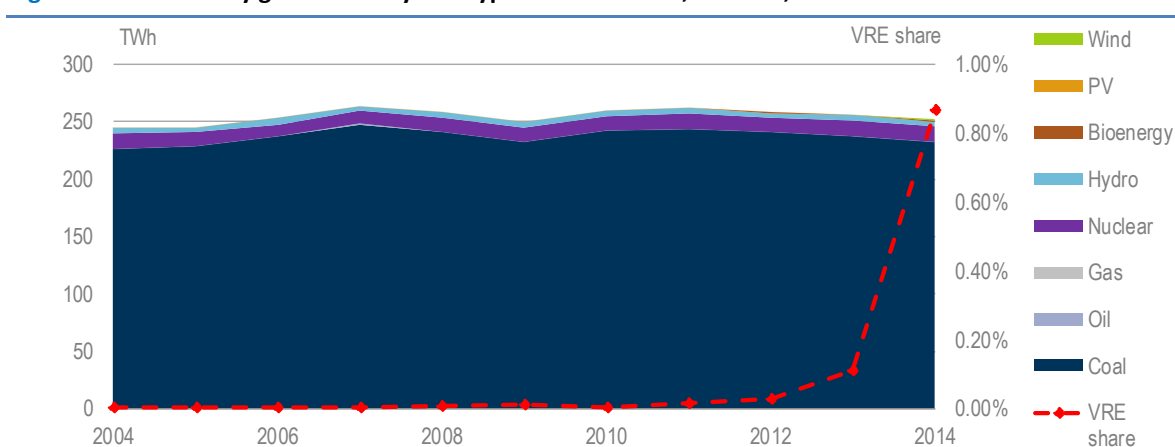

Source: IEA (2017a), *World Energy Statistics 2016*.

Key point • The share of generation from VRE increased from 2013, while remaining below 1%.

Eskom owns and operates the transmission grid, which is divided into 27 supply areas (CSIR, 2016). The utility is also responsible for 60% of distribution volumes, the remainder being sold by municipalities (PPIAF, 2014). Significant transmission capacity connects the densely populated area of Gauteng Province with the Western Cape (Figure 6.5). Despite the geographical concentration of thermal power plants, the transmission network spans extensively across the entire country, which has facilitated the cost-effective integration of the first wave of renewable energy projects in recent years. South Africa has limited electrical interconnection with neighbouring regions. In August 2011, the Department of Energy (SA DOE) introduced the Renewable Energy Independent Power Producer Procurement Programme (REIPPPP), a competitive renewable energy bidding process that was put in place following earlier attempts to introduce a FIT. The REIPPPP has been successful in stimulating both cost reductions and market deployment.

Under the REIPPPP, successful bidders sign a 20-year PPA with Eskom. The PPA's terms guarantee to the plant operator a payment per unit of energy produced in accordance with the bid tariff.

After three highly successful bidding rounds, progress under the REIPPPP has slowed. Eskom has not signed any PPAs since the last bidding round in November 2015, thus delaying the construction new VRE projects.

Figure 6.5 • South Africa's transmission grid

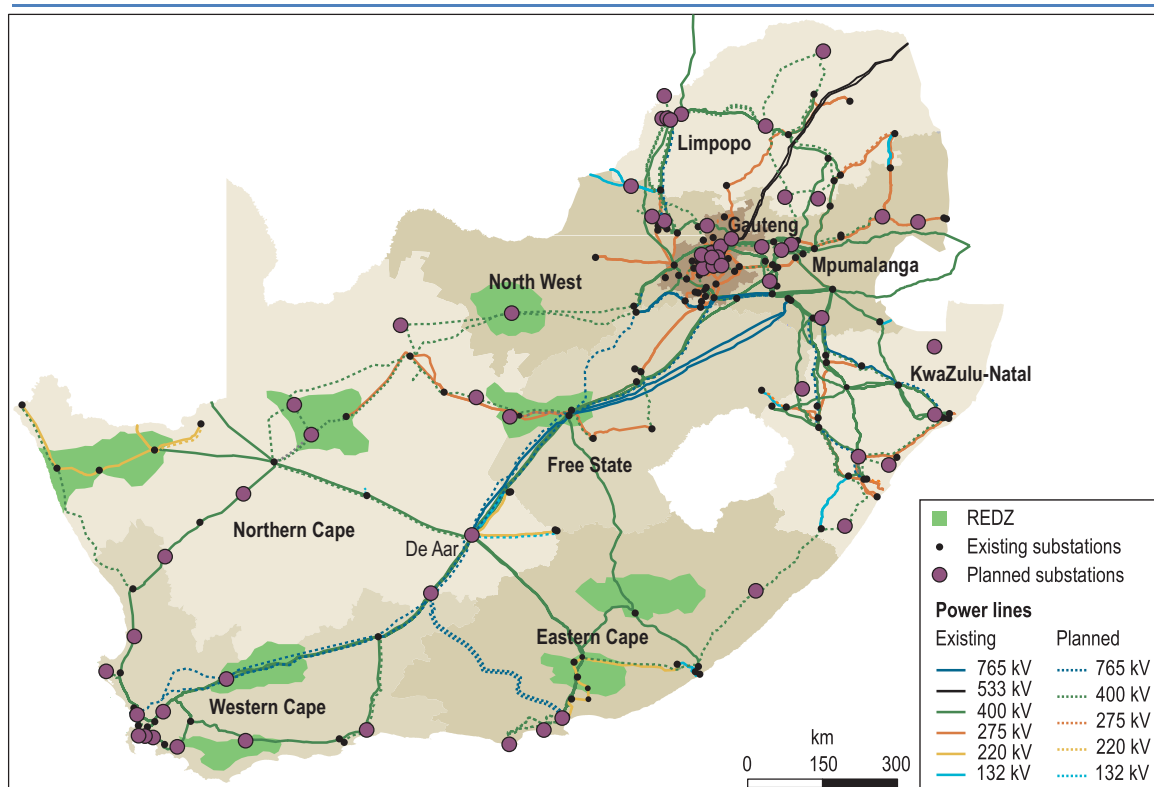

This map is without prejudice to the status of or sovereignty over any territory, to the delimitation of international frontiers and boundaries and to the name of any territory, city or area.

Note: REDZ = Renewable Energy Development Zone.

Source: Adapted from IEA (2016a), *Next Generation Wind and Solar Power*.

Key point • A strong transmission network connects the thermal plants in Gauteng to coastal load centres.

Market and operations

Wholesale level

Eskom has different types of power station, operated on a merit-order basis. Coal and nuclear power stations provide the bulk of baseload and mid-merit power, and a limited number of OCGTs serve peak-time load.

Supply-side flexibility is mainly provided by open-cycle peaking plants and hydropower. Additional sources can be procured from the 1.5 GW Cahora Bassa hydropower plant in Mozambique, which is currently run as a baseload plant, but which offers the technical capability to operate more flexibly.

Eskom uses generation fleet performance indicators, which provide thermal plant operators with an incentive to minimise outages at their plants. This can lead to situations where Eskom requests coal power plant to run at high capacity factors in order to avoid shutdowns as much as possible, reducing the hours dedicated to maintenance and thus reducing the plant's efficiency. This problem is aggravated by the high minimum output level currently applied to coal plants. Together, these operational practices inhibit a more flexible use of power plants.

Each day at 10:00, dispatchable generators submit their availability and the incremental cost curve associated with each hour of the following day. By the same hour, international traders must provide the schedule of the expected imports and exports for each hour, and consumers

with load reduction capabilities must indicate the maximum response to which the resource may be scheduled in the hour (NERSA, 2014). VRE generators at the same time indicate their hourly day-ahead production forecast. Weekly generation forecast profiles that indicate expected sales on a daily basis must be submitted every Wednesday before 09:00. At 14:00, Eskom provides a day-ahead demand forecast for each hour of the following day and a schedule for ancillary services.

As independent VRE generators enter the system and reduce Eskom's power requirements, system operations will need to provide higher levels of flexibility. This could be mobilised by changing the operating pattern of the coal fleet, within the bounds of technical capabilities of plants. As the share of variable generation grows, a review of power plant operational behaviour and scheduling could be valuable for increasing system flexibility.

Eskom is responsible for the provision of operating reserves and any other ancillary services. It determines reliability targets for the purposes of acquiring ancillary services. The reliability targets are selected in order to minimise the sum of the cost of providing the reliability plus the cost to the customer of limited reliability. Reliability targets are set according to the system average duration and frequency of interruption.

Coal power plants provide the majority of the operating reserves in South Africa, with pumped hydropower storage plants and OCGTs providing smaller amounts. One of the disadvantages of the majority of reserves being provided by coal power plants is that they must operate at part-load, which could reduce their efficiency, particularly if this is significantly lower than the designed levels (Bischof-Niemz, Calitz and Wright, 2016).

Given the small share generated by VRE, Eskom does not consider VRE in the schedule of ancillary services. As the share of VRE grows on the system, an update of schedules on the day of operation can contribute to reducing forecast errors and, consequently, the need to hold operating reserves.

Retail level

The South African retail electricity pricing landscape is highly fragmented. Municipalities buy electricity from Eskom at the wholesale price level and enjoy a large degree of autonomy in establishing customer categories, price levels and structures in their own jurisdiction. As a consequence, two businesses with an identical load profile may face very different electricity bills depending on their location.

Eskom and most municipalities apply TOU pricing to customer segments that are deemed capable of shifting the timing of their consumption.

The energy charge can be divided in two (peak, off-peak) or three categories (peak, standard, off-peak), depending on the customer category. Industrial and commercial customers that are connected to the Eskom grid are also subject to a seasonal tariff variation that distinguishes between summer (September to May) and winter (June to August) months.

The Megaflex tariff is applicable to large customers with a demand connection greater than 1 MVA and an ability to shift load (Figure 6.6). On weekdays, peak tariffs apply in the morning and evening. At the weekend, however, only the standard and off-peak tariffs apply. During the low-demand season (September to May), peak prices are 40% higher than standard prices, while the off-peak prices are 40% cheaper. Escalation is much more pronounced during the high-demand season (June to August), when peak-hour prices are 230% higher than the standard price, whereas off-peak prices are only 35% lower than the normal rate. Because of the combined effect of these different categories, there can be a sevenfold difference in the price of electricity across the year (Eskom, 2015a).

Figure 6.6 • Megaflex tariff hours structure

Low-demand season																								
	0	1	2	3	4	5	6	7	8	9	10	11	12	13	14	15	16	17	18	19	20	21	22	23
Weekdays	Off-peak	Off-peak	Off-peak	Off-peak	Off-peak	Off-peak	Standard	Peak	Peak	Peak	Standard	Standard	Standard	Standard	Standard	Standard	Standard	Standard	Peak	Peak	Standard	Standard	Off-peak	Off-peak
Saturday	Off-peak	Off-peak	Off-peak	Off-peak	Off-peak	Off-peak	Off-peak	Standard	Standard	Standard	Standard	Standard	Standard	Standard	Standard	Standard	Standard	Standard	Standard	Standard	Standard	Standard	Standard	Standard
Sunday	Off-peak	Off-peak	Off-peak	Off-peak	Off-peak	Off-peak	Off-peak	Off-peak	Off-peak	Off-peak	Off-peak	Off-peak	Off-peak	Off-peak	Off-peak	Off-peak	Off-peak	Off-peak	Off-peak	Off-peak	Off-peak	Off-peak	Off-peak	Off-peak

High-demand season																								
	0	1	2	3	4	5	6	7	8	9	10	11	12	13	14	15	16	17	18	19	20	21	22	23
Weekdays	Off-peak	Off-peak	Off-peak	Off-peak	Off-peak	Off-peak	Peak	Peak	Peak	Standard	Standard	Standard	Standard	Standard	Standard	Standard	Standard	Peak	Peak	Standard	Standard	Standard	Standard	Standard
Saturday	Off-peak	Off-peak	Off-peak	Off-peak	Off-peak	Off-peak	Off-peak	Standard	Standard	Standard	Standard	Standard	Standard	Standard	Standard	Standard	Standard	Standard	Standard	Standard	Standard	Standard	Standard	Standard
Sunday	Off-peak	Off-peak	Off-peak	Off-peak	Off-peak	Off-peak	Off-peak	Off-peak	Off-peak	Off-peak	Off-peak	Off-peak	Off-peak	Off-peak	Off-peak	Off-peak	Off-peak	Off-peak	Off-peak	Off-peak	Off-peak	Off-peak	Off-peak	Off-peak

Peak

Standard

Off-peak

Note: Low-demand season runs from September to May, and high-demand season from June to August.

Source: Reprinted from IEA (2016a), *Next generation Wind and Solar Power*.

Key point • For applicable customer categories, TOU pricing models set three different tariff levels, differentiated by season, day of the week and hour.

For customer categories that are subject to demand charges, an excess network access charge will be levied for exceeding the notified maximum demand (NMD), after allowing for two exceedances over 5% during a rolling 12-month period (Eskom, 2015a).

Taxes are inflexible across the day and seasons, and therefore they diminish the effect of TOU pricing. Taxes can be 20% of the overall energy price during peak hours in the high season and 65% during off-peak hours. Municipalities often use tax revenue collected through electricity tariffs to finance other governmental functions outside of electricity distribution.

Offering TOU tariffs to residential consumers, encouraging their uptake, and proposing flexible retail tariffs that reflect the real value of energy may help smooth demand and reduce the peak net load.

For large industrial or commercial customers, Eskom applies transmission loss factors. Eskom calculates these factors on the basis of the customer's distance from Johannesburg. These loss factors serve as a proxy for the system cost related to transmitting power to various parts of the country. These charges are set annually and provide only a minor indication of the locational value of energy.

By the end of 2016, about 170 MW of distributed solar PV had been installed across South Africa (PQRS, 2017). Although these numbers are low by international standards, VRE uptake at a local level has started to pick up in recent years in response to load shedding, improving cost competitiveness and increasing guidance on technical interconnection rules. Remaining legislative gaps have constrained the installation and connection of VRE systems of less than 1 MW. In 2015, the energy regulator published a consultation paper which proposed a relaxation of several legal hurdles to small-scale (<1 MW) VRE deployment (NERSA, 2015). Eskom is in the process of setting up the legal, technical, metering and tariff framework for the connection of small-scale PV system to the low-voltage network (Eskom, 2017).

Planning and infrastructure development

Integrated planning frameworks

The Integrated Resource Plan (IRP) 2010-30, published by the SA DOE (2011), set out a clear framework for expanding generation capacity between 2010 and 2030, and notably stipulated the procurement of 17 800 MW of renewable energy projects and 9 600 MW of nuclear capacity. The IRP uses various scenarios and cost assumptions to decide how much of each technology must be procured each year in this timeframe. In principle, the IRP is revised every two years by the SA DOE on the basis of a comprehensive cost-benefit analysis of the various technologies (SA DOE, 2011). The IRP 2013 update, which notably deferred any decisions on nuclear energy procurement, was promulgated but never adopted by the Cabinet. In November 2016, the SA DOE released a new IRP 2016 base case, which, as of March 2017 remains open to public comment.

One of the main political criticisms of the IRP 2010-30 was that it was developed without an appropriate overarching energy plan, neglecting to consider the interactions with other energy sectors and carriers. Therefore, the planning activities of the SA DOE have focused more recently on the overall Integrated Energy Plan (IEP), of which the IRP updates comprise the electricity-related content.

Electric grid planning

Eskom's "Transmission Development Plan 2016-2025" sets out a transmission grid development strategy. This task is becoming more difficult as private-sector development is scattered across the country. A particularly challenging aspect of REIPPPP activity is that Eskom can determine precise grid reinforcement requirements only after the results of the tenders have been finalised (Eskom, 2015b).

Since transmission upgrades are time intensive, they can impose delays on IPP projects. A number of initiatives have been undertaken to facilitate the REIPPPP, which include the introduction of a self-build procedure that provides IPPs with the option to build their own dedicated connection infrastructure.

Increasing connection costs around traditional hotspots may shift IPP development to other areas. In order to minimise overall system costs of further wind and solar PV development, IPPs may face incentives to widen the geographical distribution of new projects. Doing so successfully will decrease grid investment needs.

In February 2016, the South African Cabinet approved the designation of eight Renewable Energy Development Zones (REDZ) and five Power Corridors in line with a strategic assessment undertaken by the Department of Environmental Affairs (SA DEA, 2016). REDZ indicate those areas in which VRE development is considered most appropriate strategically. By anticipating deep grid expansion works, the REDZ indirectly signal which areas will have relatively lower connection costs. Eight REDZ were identified (Figure 6.5).

The SA DOE can incorporate location-specific incentives in the Request for Proposals (RfP) for subsequent bidding rounds. When releasing the RfP for the next round of the auctions, which sets out the tender rules, the SA DOE has the opportunity to add location-specific incentives to direct project development towards these REDZ.

Uptake of innovative technologies

Smart technologies

The 2008 National Energy Act mandates the South African National Energy Development Institute (SANEDI) to conduct research activities and to undertake measures to promote energy efficiency throughout the South African economy. On this basis, SANEDI has launched a series of initiatives and research projects to improve the intelligence of local grids.

Nine smart grid projects, with different objectives, are currently in place for capacity building and to further understanding of South Africa's particular challenges for the deployment of smart technologies.

Local grid management is a municipal responsibility, and profits from electricity sales can represent a sizeable portion of municipal income (CSIR, 2013). As a consequence, local authorities have often been reluctant to incentivise the uptake of decentralised supply, such as rooftop solar PV systems, as these may erode the municipal revenue base.

Flexible resources

As the share of VRE in total electricity consumption is currently very low, curtailment of VRE is likely to remain limited for the foreseeable future. Moreover, IEA analysis shows that wind and solar production in South Africa fits relatively well with demand (IEA, 2016a). If well managed, rising levels of VRE penetration are unlikely to create significant requirement for additional storage solutions.

A shortage of power generation became apparent in late 2007, when Eskom was forced to implement load shedding to balance the system. Load shedding was again employed in November 2014 due to growing demand and delays in the commissioning of the Kusile and Medupi coal-fired power plants, combined with the decreasing availability of existing plants (SA DOE, 2015). Currently, Eskom holds contracts with industrial and commercial consumers to suspend over 450 MW of load over a given time through the Supplemental Demand Response Compensation Programme (Eskom, 2016).

In the future, the inclusion of more demand-side flexibility resources may strengthen system operation and reduce the risk of load shedding. However, this will require substantial changes to the current institutional and regulatory framework in South Africa.

Resource-efficient technologies

The competitive nature of the REIPPPP caused IPPs to search for project sites with the lowest possible production cost. Although project development in resource-rich areas enables an optimal utilisation of South Africa's plentiful natural resources, a geographical concentration of projects is placing increasing pressure on overall system costs due to rising grid connection costs. IPPs operating under the REIPPPP receive fixed, inflation-linked compensation on the basis of a 20-year PPA with Eskom. As such, energy production from these resources does not take into consideration the actual locational and temporal value of the resource.

Different plant design options can be adopted to improve the system value of VRE production. Developers may choose to implement them if a precise market signal highlights when and where energy is needed most. The SA DOE could consider a partnership with Eskom's grid planning unit to calculate and add "delivery costs" to prospective locations of IPP projects.

Efficiency and sector coupling

Electrification of the transport sector

There were fewer than a thousand EVs in South Africa in 2015 (IEA, 2017c). However, anticipating growing uptake, two cars manufacturers have rolled out EV charging stations in Cape Town. In 2013, Eskom initiated a research project on the charging requirements and characteristics of EVs in order to prepare the power system for the entry of this technology.

Development of a better understanding of how EVs will affect consumption patterns, the generation mix and any necessary grid reinforcements would allow future issues connected with this technology to be anticipated and prevented.

Electrification of heating and cooling

Heating demand – e.g. space and water heating – is largely electrified in South Africa. Electric water heating capacity amounts to almost 30 GW. Efforts are ongoing to try to harness the flexibility potential that can be sourced from this equipment (LBNL, 2015).

Smart technologies, in combination with enabling regulatory frameworks, could unlock this thermal storage potential as a viable means to increase grid flexibility, while at the same time providing energy savings to consumers. This could be achieved through establishment of more granular TOU rates for consumers, or via regulated demand response programmes administered by Eskom or municipalities, which aggregate customer demand. Alternatively, more substantial regulatory or policy shifts could allow private-sector aggregators to sell demand response products directly to municipalities or Eskom.

Energy efficiency

South Africa's government recognises the importance of energy efficiency and, in recent years, a number of policies have been enacted to deploy energy efficiency interventions:

- In 2013, tax deduction legislation was approved for businesses up to 2020. Regulations in July 2015 increased the rebate on taxable income to USD 0.07 (ZAR 0.95) per kWh of energy saved.
- Eskom and municipalities have introduced various incentives and public information campaigns to encourage the deployment of energy-efficient solar water heating and to reduce their use during the peak hours (LBNL, 2013).
- The Green Energy Efficiency Fund provides credit financing to small and medium-sized enterprises for energy efficiency interventions. USD 38 million are available under the fund scheme.

Summary and main observations

Table 6.3 • Key attributes and options for South Africa

Market and operations
Wholesale level
Power plant performance indicators stimulate thermal power plant operators to increase total operating hours. Modifying these performance indicators to encourage flexible operations may support power system transformation as further VRE generation is added, leading to lower overall system costs.
Retail level
Interest in distributed solar PV has increased in recent years. Important steps have been made with the finalisation of connection standards for low-voltage grids. Current efforts to empower municipalities in establishing rooftop solar systems merit ongoing support. Revenue collection and non-technical losses remain important focus areas. The smart grid pilot run by SANEDI can assist in overcoming these issues.
Planning and infrastructure development
Integrated planning frameworks
The IRP sets out a clear pathway to a more diverse and expanded supply mix. Ongoing collaboration between the SA DOE, Eskom and other relevant stakeholders remains a key precondition to a successful implementation of the anticipated capacity additions.
Electricity grids
A particularly challenging aspect of REIPPPP activity is that Eskom can assess precise grid reinforcement requirements only after the results of the tenders have been finalised. The SA DOE has the opportunity to add location-specific incentives to direct project development towards the REDZ.
Uptake of innovative technology
Flexible resources
DSM programmes are limited to load-shedding contracts. A more pervasive use of demand-side resources, particularly heating demand, could be enabled by regulatory shifts and utility aggregation programmes, uncapping significant grid flexibility and consumer cost savings potential.
Resource-efficient technologies
The REIPPPP scheme does not require VRE project developers to search for areas best suited for power generation or to adopt specific plant design options to enhance the value of the produced energy. The SA DOE has the opportunity to add location-specific “cost of delivery” adders for contract prices, or other forms of time/location-specific incentives in the REIPPPP.
Efficiency and sector coupling
Electrification of the transport sector
EVs are not currently a political priority, but their impact on the grid is under investigation by Eskom. Advancements in the understanding of how EVs will affect the power system can anticipate and avoid system costs.
Electrification of heating and cooling
South Africa’s residential heat demand is already largely electrified. Changes to public policy and regulatory frameworks to allow smart DSM of this resource will bring great potential for flexibility into the system.
Energy efficiency
Further efforts to improve energy efficiency performance in the residential and industrial sectors would benefit the entire power system, in particular if focused on reducing consumption during peak hours.

Mexico

General overview of the Mexican power sector

Mexico is in the process of implementing a comprehensive and ambitious reform of its energy sector. The reform aims to resolve a number of structural challenges that the sector has been facing. As regards the electricity system, the incumbent state-owned monopoly utility, Comisión Federal de Electricidad (CFE), has struggled to deliver the required levels of investment in new generation capacity. Manufacturing industry has suffered higher electricity tariffs relative to the United States. Moreover, electricity revenues have not allowed for full cost recovery. For example, in 2014, 21.1% of the total cost of electricity supply had to be covered by the general government budget (IEA, 2016b).

To respond to these challenges, constitutional reform in 2013 set the stage for a major overhaul of the energy sector, including the electricity industry. To open up the market to competition, CFE has been unbundled, with its generation and distribution activities split across different entities.

Energy reform introduced a number of products that are traded on a long-term basis: electricity, clean energy certificates (Box 6.1), and capacity. By introducing competition for the long-term supply of these products, energy reform seeks to foster private-sector investment in clean energy technologies while minimising the associated cost. Market participants can also trade financial transmission rights (FTRs).

In parallel, the introduction of wholesale markets has facilitated trade in energy and ancillary services, allowing market participants to correct for imbalances. The wholesale market consists of day-ahead and real-time markets. A newly established independent grid operator, Centro Nacional de Control de Energía (CENACE), is designated to manage the wholesale market, which started operating in early 2016.

In 2015, Mexico generated 309 TWh of electricity, around 15% of which came from renewable plants. VRE generation was estimated to account for 2.5% of total generation, mostly from wind farms. This share is expected to increase from 2018, as the effect of long-term auctions is seen (SENER, 2016a).

Figure 6.7 • Electricity generation by fuel type and VRE share, 2005-15, Mexico

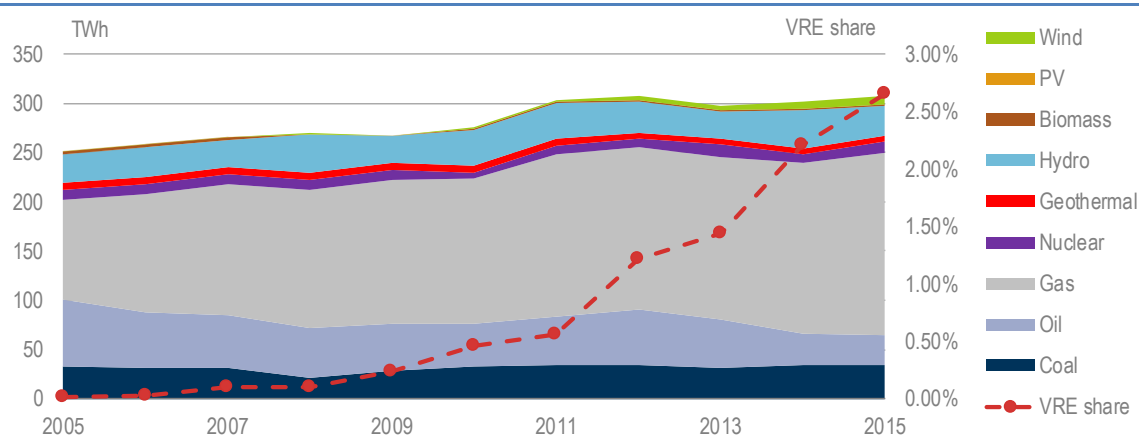

Source: IEA (2017a), *World Energy Statistics 2016*.

Key point • Natural gas dominates Mexico's generation mix; VRE is growing rapidly from a low base.

Between 2005 and 2015, electricity generation from gas increased most rapidly (Figure 6.7), displacing significant amounts of heavy fuel oil. However, in the last five years, the amount of wind generation has increased to the extent that it reached a level similar to geothermal generation, which was the third most important source of clean energy (behind nuclear and hydropower). The growth in wind, solar, and geothermal generation is expected to accelerate due to the long-term energy auction mechanism that has been put in place.

Physically, the market operates over an integrated grid that represents more than 95% of demand, the National Interconnected System (SIN), and two independent systems, one of which is interconnected to California, and two additional isolated systems in the south of the Baja California peninsula (Figure 6.8). These will interconnect in coming years. Mexico also has 11 cross-border interconnections with the electric power systems of the United States in the north, and two more with Guatemala and Belize in the south. Dispatching and transmission operations are co-ordinated by the system operator, CENACE, notwithstanding significant transmission restrictions between different regions of the country.

Figure 6.8 • National transmission grid of Mexico, 2014

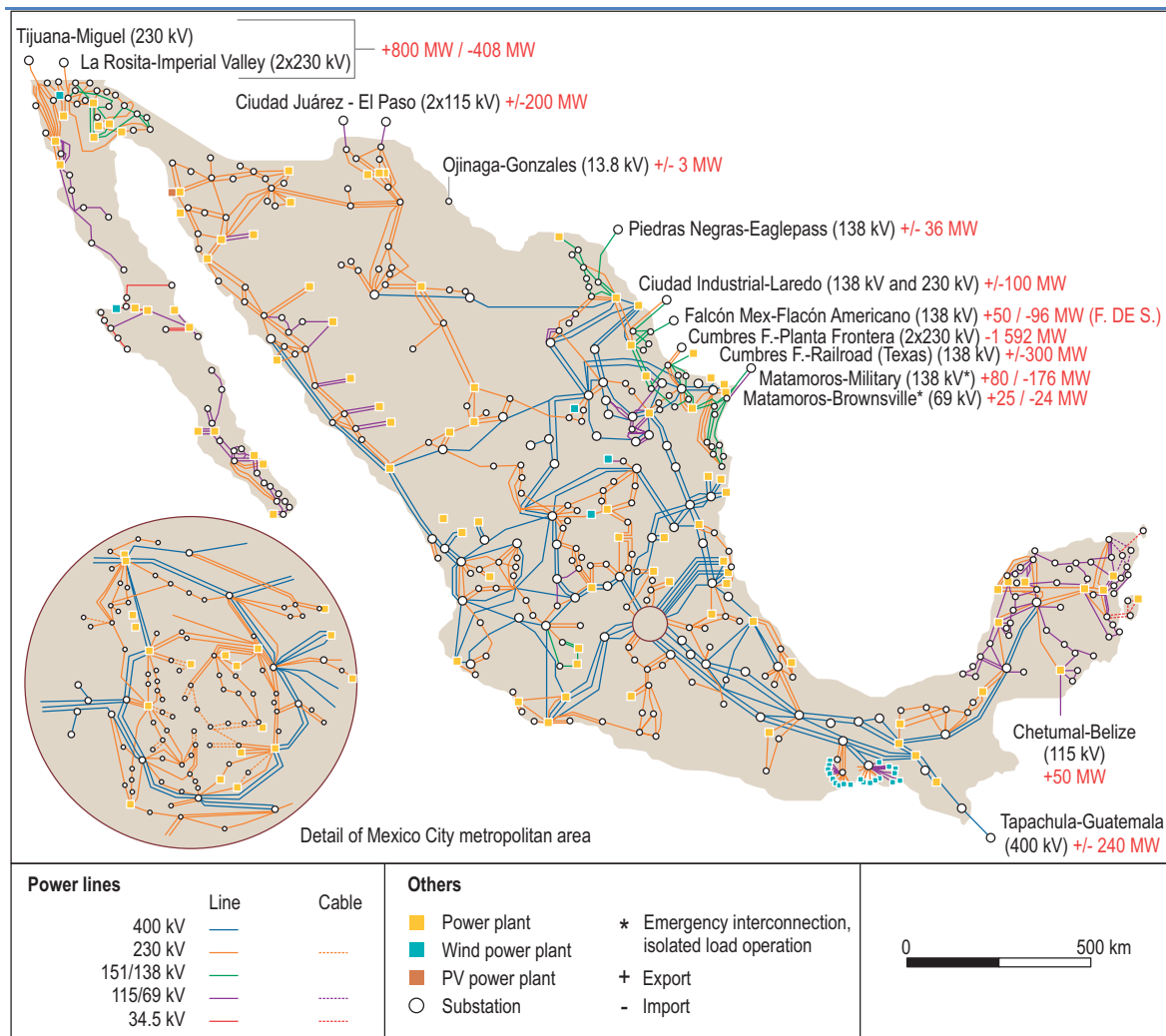

This map is without prejudice to the status of or sovereignty over any territory, to the delimitation of international frontiers and boundaries and to the name of any territory, city or area.

Source: Reprinted from IEA (2016a), *Next Generation Wind and Solar Power*.

Key point • Mexico has a developed transmission grid in the central regions.

Markets and operations

Wholesale level

Bulk system operation

The wholesale system operates with five-minute dispatch periods. Certain types of generator, such as nuclear, geothermal, VRE and legacy self-suppliers,²⁷ do not receive dispatch instructions to change outputs from CENACE, for technical and regulatory reasons. All units operating under the wholesale electricity market communicate in real time with CENACE for monitoring and dispatching adjustment purposes (when applicable), based on updated dispatching schedules with 1 day, 1 hour and 15 minute timeframes (CRE, 2016). Dispatch must consider not only generation capacity, but also controllable demand resources.

In addition to the forecasting provided by legacy contract generators (including legacy IPPs and self-suppliers), many of which correspond to wind generation in the state of Oaxaca, CENACE accesses continuous updates from generators following previously provided production schedules. In the case of Oaxaca, CENACE has also developed a statistical forecasting model to supplement its dispatch decision making. In the case of hydropower, special inputs are taken from the National Water Commission as the authority in charge of managing water basin operations (CRE, 2016).

A manual containing provision regarding forecast rules is under approval; in the proposed rules, VRE producers are required to submit forecasts for electricity generation in real time to CENACE. Forecasts have a time horizon of 2 hours (i.e. 8 intervals of 15 minutes) and are updated every 15 minutes (CENACE, 2015).

Requirements are distinct for synchronous and non-synchronous generators and by power plant size. Non-synchronous generators can be requested to provide ancillary services, in particular reactive power and voltage control.

Electricity market framework

Mexico's wholesale market began operation in January 2016, only two years after the enactment of the reform law. In the new structure, the market is open for generators to participate competitively. At the end of 2015, the onset of the market operation, CFE and legacy IPPs accounted for an installed capacity of 55 GW, while self-supply accounted for 13 GW (Figure 6.9).

The wholesale market is expected to be fully operational by 2018. Several energy products are traded on the day-ahead market (DAM) and the real-time market (RTM), or by means of bilateral contracts. Products are traded in hourly blocks and prices are set on a nodal basis. In the DAM, energy products are based on hourly bids. Market participants can either make fixed offers (buy/sell at any price) or price-sensitive bids (buy/sell only if the price is below/above a certain price).

The RTM is available only for dispatchable plants; solar PV and wind power plants can participate if they have the capacity to reduce generation by means of automatic dispatch instructions.

²⁷ Legacy refers to the legal term given to generators which had signed contracts with CFE before the reform. These generators retain the right to be regulated under the previous legal framework, particularly fees for wheeling services and no limitations on dispatching in the case of self-suppliers. Self-supply describes a legal form that is applicable both to local self-supply and production-consumption associations allowed under the previous legal regime, which resemble bilateral contracts.

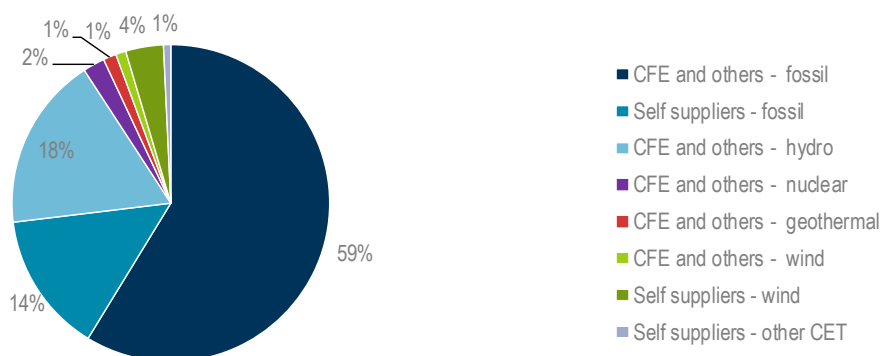
Figure 6.9 • Capacity mix in the wholesale market, Mexico, 2016.

Source: Adapted from SENER (2017), *Cuestionarios Anuales de la Agencia Internacional de Energía* [International Energy Agency Questionnaires].

Key point • Renewable energy power plants account for 25% of approximately 68 GW of total installed capacity.

Currently, the RTM clearing price is pegged to the DAM price. Starting in 2018, RTM offers can have different prices from the DAM. Around this time, the DAM and RTM will be complemented by an hour-ahead market. Consumers with aggregate consumption levels greater than 5 MW are “market participant qualified users”, and are permitted to purchase energy directly in the wholesale electricity market without an intermediary.

Box 6.1 • Clean Energy Certificates

The Energy Regulatory Commission, CRE, sets a quota obligation of Clean Energy Certificates (CECs) for parties purchasing electricity. CECs are awarded to generators using clean energy technologies (CET)²⁸ for each megawatt hour (MWh) of power generated without fossil fuels (the stipulation to allocate CECs only for the non-fossil fuel component relates to co-generation facilities specifically)²⁹. The market for CECs creates an additional revenue stream for low-carbon generators.

Eligible customer categories include retailers, large consumers, end-users with isolated supply and load centres included in legacy interconnection contracts. The quota is set three years prior to the compliance period as a percentage of total consumption. The first compliance period will be in 2018, with the quota set at 5% of annual electricity consumption for eligible parties; the target increases to 5.8% in 2019. In the instance that the purchasing party does not meet its obligation, the penalty for non-compliance can reach an estimated USD 200/CEC. CRE will monitor trading in the CEC market

IEA (2016a), Next Generation Wind and Solar power

Mexico’s wholesale market incorporates mid- and long-term auctions. Mid-term auctions cover energy and capacity under three-year contracts, while long-term auctions are open only to CET operators.

²⁸ Although the CET category includes nuclear, carbon capture and storage, and efficient co-generation, only capacity commissioned after August 2014 is eligible for CECs. Hence, existing nuclear and most co-generation capacity cannot receive CECs.

²⁹ Co-generation refers to the combined production of heat and power

Long-term auctions award 20-year contracts for CECs, in addition to 15-year contracts for energy and capacity. The latest long-term clean energy auction is looking to deliver of at least 8.9 gigawatt hours of clean energy at an average price of USD 33.47 per MWh plus CEC, equivalent to more than all the energy from geothermal energy currently available (CENACE, 2016). Moreover, CECs can be bought and sold through the spot market.

To address adequacy concerns, a capacity market was implemented in March 2017, following the development of appropriate market rules and grid code-specific criteria to assess capacity requirements.

Ancillary services remuneration is provided in through two different mechanisms. In the first mechanism, dedicated to operating reserves, the price of ancillary services is calculated by CENACE on a nodal basis, together with the nodal prices of electricity of the DAM and RTM, and is based on the marginal costs of the dispatch. Until 2018 these prices will be capped.

A second mechanism, for ancillary services not procured through the wholesale market (as reactive power, black start, voltage control etc.) will be in place; CRE, will regulate the applicable tariffs (CRE, 2016).

In order to allow market participants to hedge for congestion-related price risks, FTRs were introduced in 2015. These provide the holder the right to collect and obligation to pay the difference between the values of the congestion component of the nodal marginal price from a node of origin to the node of destination.

Since 2017, FTRs can be acquired through auctions for expansion of the transmission network or by assignment. In the transition into wholesale markets, legacy generators are allocated with rights (IEA, 2016a).

Retail level

The unbundling of CFE resulted in the creation of a distribution company, a transmission company, a general service retail company with 16 regional subsidiaries, and a qualified users retail company. In practice, the general service retail company will serve more than 38 million clients, while the qualified users retail company will compete for more than 4 000 larger clients, with an aggregated demand level greater than 1 MW.

The current domestic tariff structure subsidises different levels of consumption for more than 98% of households. In 2014, when the last estimates were presented by CFE, these amounted to USD 5.47 billion, and the domestic user paid on average only 39% of the real cost of energy consumed. The current tariff structure does not help identify this subsidy and it reduces the incentives for investment in distributed generation.

Domestic tariffs are defined geographically, based on average consumption, and are therefore not intended to provide an incentive to change consumption patterns according to the cost of available generation resources.

All commercial and industrial consumers, local governments and any other consumer that is not explicitly considered a household pay a non-subsidised tariff, but there is only limited scope for regional differentiation, with the 16 regional subsidiaries.

Distribution companies provide information to CENACE's regional control centres, and these are collated at the control centre. No specific initiatives are in place to enhance the monitoring of renewable resources at the distribution level.

In early 2017, CRE approved a new regulation for the compensation of distributed generation, but its final publication in the Official Gazette of the Federation remains pending. This regulation

allows individual generators with an installed capacity below 500 kilowatts to feed electricity into the grid and be paid under three different options: a net metering option, a net billing option, and a total sale scheme option. This new regulation and the Interconnection Manual, published by Mexico's Department of Energy (Secretaría de Energía or SENER) on 15 December 2016, are expected to set the basis for the uptake of distributed generation in Mexico and to increase current installed capacity from 151 MW to at least 527 MW by the end of 2018, as established in the Special Programme on the Energy Transition Strategy (SENER, 2016b, 2016c).

Planning and infrastructure development

Integrated planning frameworks

Mexican institutions have a long tradition of integrated planning of the energy system. Under the 2013 energy reform, SENER, CENACE and CRE assumed distinct roles in the development of infrastructure programmes and indicative production planning (IEA, 2016b).

Market reform has led to a change in planning criteria, from assisting the national public investment programme to considering multiple objectives. These include prioritising grid development for new generation projects, promoting renewable resources, maintaining system reliability, fostering technical and economic optimisation, and informing other strategic policy and investment decision making (Shah et al., 2016).

The legal framework specifies a multi-stage iterative planning process, divided into three timeframes:

- Short-term planning corresponds to periods of one to five years, evaluating optimisation and reliability priorities, including specific risks to the system.
- Medium-term planning corresponds to periods of six to ten years, and its contribution is already reflected in the Indicative Programme for the Installation and Commissioning of Capacity (PIIRCE by its Spanish acronym), and in particular is relevant for the specific investment programme to extend and modernise the transmission and distribution grid.
- Long-term planning comprises the period between 11 and 15 years into the future, and establishes a vision of how the future development and deployment of technology in the sector may evolve (CRE, 2016).

These planning processes can be viewed as independent of each other, but they are also formally integrated into the National Programme for the Development of the Power System (PRODESEN by its Spanish acronym) (SENER, 2016d).

Regional aggregate demand forecasting and indicative generation planning consider structural and market variables, including population growth rates, economic growth rates and the cost of investment and fuels. Until recent planning exercises, renewable energy and other clean technologies were incorporated into the planning process as mid- and long-term limits in the planning models, based on the legal mandates to increase the share of clean energy in the system.

Planning has relied on deterministic models. The grid code recognises the need to better address the challenge of uncertainty and allow the development of weighted scenarios, stochastic analysis and the application of minimax decision rules (i.e. decision rules for minimising the possible loss in the worst case scenario) (CRE, 2016). SENER has, in different ways, acquired and developed more flexible tools that allow it to create scenarios that are more readily updated by the market and the regulatory process. These tools in particular consider three new inputs: interconnection applications, wholesale market prices and long-term energy auction prices. Indicative generation planning has been developed using the capacity expansion model of

PLEXOS LT, while policy commitment scenario modelling has been developed by an in-house integrated modelling system (SIMISE) developed by the Autonomous National University of Mexico (UNAM) on the different subsectors of the energy system.

Six months after the publication of the 2016 edition of PRODESEN, SENER published new long-term scenarios that correspond to mandates in the Energy Transition Law in the Electricity Sector Outlook, but which do not entirely correspond to the power system plans of PRODESEN. There is a natural lag between the incorporation of climate change policies into the power system planning, but the inclusion of specific policy-driven changes into the planning system remains to be achieved, including those derived from the energy efficiency programme (PRONASE) and climate change programme (PECC).

Grid expansion

Prior to the energy reform, grid expansion to serve renewable energy faced at least three barriers: lack of available financial resources, limited spare management skills for the development of new projects within CFE, and an inhospitable regulatory framework for the development of those new projects serving the need of private producers.

Under the previous framework, CFE could not legally include an assessment of the potential growth of private-sector projects into the planning process, which resulted in limited spare transmission capacity for the interconnection of large renewable energy projects (Shah et al., 2016).

After the reform, the Mexican government is giving specific attention to better evaluating the regional availability of VRE and to facilitate transmission investment decisions to incorporate them into mid-term planning. The process allows important resource data and strong analytical information to be provided to the private sector on potential regions for the development of new renewable energy projects, and in return the process allows for private sector to share the level of interest in those regions.

SENER and CENACE then use this information to prioritise the Clean Energy Zones (CEZs), which are set by SENER as feasible areas for the development of renewable energy generation projects, and the building of the necessary transmission capacity.

The purpose of the CEZ policy is primarily to influence the future development of the grid and to inform a broad set of stakeholders and the public, but not to have any impact on auctions or any price incentive mechanism.

Future transmission projects are evaluated taking into account various system benefits, including the reduction of losses, the increased integration of clean energy and the greenhouse gas emission reductions. It is not yet clear how some of these benefits will be economically valued, but precedent exists in Mexican public finance management to account for the social price of carbon emissions as an indicator for the evaluation of the social return of public investment projects (SENER 2016d; CRE, 2016).

Long-term energy auctions specifically incorporate adjustment factors to reflect the difference in nodal pricing of energy and the transmission constraints, highlighting the locational value of the projects, in order to understand the overall system benefit from the new generation.

Transmission grid expansion remains the responsibility of the government, executed through the management of the CFE transmission subsidiary. In the future, new forms of association and contracting may take place to allow private-sector participation; SENER will remain the approving authority and may instruct CFE to develop the transmission projects through either associations or tenders.

In the 2016 PRODESEN, a number of important grid expansion projects were included that directly relate to the integration of renewable energy. These include the first DC transmission line from the southern region of the Itsmo de Tehuantepec to the Valle de México (2020) to serve the expansion of wind energy in the region, with additional capacity of 3 000 MW, a transmission grid upgrade in the northwestern states of Tamaulipas and Nuevo León (2021) to accommodate as much as 5 000 MW of new wind energy, and the interconnection of the region of Baja California with the national grid (2021), which will similarly favour the expansion of solar and wind energy projects in that region (SENER, 2016c). For the purposes of developing indicative generation planning for PRODESEN, SENER used specific levelised cost of electricity data for wind and solar technologies at each of Mexico's nodes. As this information continues to be refined in the coming years, subsequent improvement will allow the identification of specific high-value regions and their consideration in grid planning (SENER, 2016b).

Uptake of innovative technologies

Smart technologies

In May 2016, SENER published its first Smart Grid Programme, which will be updated every three years. The main goal of this programme is to support the modernisation of the national transmission and the general distribution grids. This is to facilitate the integration of large clean-energy projects and promote clean distributed generation in a reliable and secure manner. According to the programme, Mexico's electric power system will have a partially smart grid by 2022, gradually increasing so that a highly automated transmission and distribution infrastructure can be available by 2031 (SENER, 2016d).

The regulatory framework is conducive to the adoption of smart technologies, but due to the early market experience of consumers in Mexico and lack of dedicated regulation, there has been no significant uptake of smart technologies so far. The Mexican government has opted for defining investment strategies that address immediate challenges concerning system reliability and losses. Other priorities include cyber-security and increased integration of VRE.

The upgrade of metering systems will represent an opportunity for future efforts to increase distribution grid monitoring capabilities, in particular in urban centres where non-technical losses tend to be higher. At the utility-scale level, key transmission projects to implement smart-grid technologies are under way.

Flexible resources

PRODESEN 2016 includes the need to evaluate storage solutions in southern Baja California, in particular a 10 MW battery project to integrate 90 MW of additional renewable energy. This could provide significant experience in a system that is considered, by some, to have reached operational constraints for the integration of intermittent renewable energy (SENER, 2016d).

SENER included storage as one of the key innovation priorities in the development of the Energy Transition Strategy published in late 2016, but other than the southern Baja California peninsula initiative, only CFE has started to assess the potential for the development of pumped hydropower systems in different regions in the country.

Mexico is part of the international Mission Innovation initiative to speed up funding for research and development. Currently the process is unfolding for the section of the consortia that will manage the Mexican Centre for Smart Grids, which will become the focal point for technology and policy innovation in coming years.

Controllable demand contracts are market instruments, already developed under the monopoly system of CFE, for which there is experience through “interruptible demand” contracts for high-tension consumers. CFE applies a bonus or compensation for interrupting a certain level of demand, with notifications 15 and 30 minutes in advance.³⁰ This instrument provides immediate experience for assessing the incorporation of other flexibility resources, such utility storage, as a resource in the wholesale market. However, these have yet to be offered on the wholesale market. The range of consumers who could be incentivised by new regulation is nevertheless limited by the current domestic tariff structure, due to the presence of subsidies.

Power system technologies such as utility-scale and distributed storage, distributed demand management and control, or EVs, have yet to be assessed in relation to power system planning.

Planning capacity and institutional arrangements can be readily put in place for the assessment of changes to operational practices, grid upgrades and new market products.

Resource-efficient technologies

In the auction system, location-specific price correction adds direct project development in favour of specific regions. Once in operation, the energy price for VRE is time dependent. CENACE models anticipate electricity prices that are then used for setting hourly price adders for the entire length of a project, as determined by a PPA, and on a region-specific basis.

In essence, those producers that offer electricity with a higher-than-average value can reduce their bids in two steps. In the first step, project developers consider the hourly price adders that will apply in the location of their choosing. They will incorporate this into the price they bid into the auction. In the bid selection, the regulator applies a further correction factor related solely to location, which is used for selecting projects but not for compensating generators.

This system of price calculation pushes bidders to design their plants in a way that optimises the system value of electricity production.

Efficiency and sector coupling

Demand-side strategies will play a greater role in the future. SENER’s “Strategy to Promote the Use of Cleaner Technologies and Fuels” envisages an energy transition scenario where clean energy will account for 50% of total power generation by 2050 (SENER, 2016a). The strategy acknowledges that in order to reach this national goal, the country will have to undertake important energy efficiency actions in order to reduce its final energy consumption by 42% with respect to the business-as-usual scenario.

In the short term, this will require current energy efficiency programmes to be maintained, while in the medium and long term, structural changes will be required in the transport, industry and building sectors. The main opportunities were found to be in public and private transport electrification, recycling, process integration and combined heat and power in industry, as well as the improved energy performance of residential and commercial buildings.

³⁰ The supplier (CFE) can only limit supply for 6 hours in one day no more than 20 times in a year for the 15-minute notice contract, and 4 hours in one day no more than 14 times a year for the 30-minute notice contract.

Summary and main observations

Table 6.4 • Key issues and options for Mexico

Market and operations
Wholesale level
<p>The implementation of the wholesale spot market has been partially completed; important aspects of the reform are still pending. Continued implementation of all aspects of the reform will be critical to operating the system efficiently and unlocking the contribution of new players, such as demand-side resources.</p> <p>The auction system allows for the identification of the plants with higher locational and time value. Further improvements to recognise the specific value of each project may lead to lower overall system costs.</p>
Retail level
<p>Highly subsidised electricity tariffs in the residential sector still hinder the deployment of distributed generation technologies such as solar PV, while imposing a very large budget constraint on the government. A key challenge is to design innovative support mechanisms that reduce such burden on the public budget while finding new mechanisms to still assist low-income groups.</p>
Planning and infrastructure development
Integrated planning frameworks
<p>Based on previous experience with power system planning, Mexico has developed quite a sophisticated system of integrated planning. Further improvements are key for a successful transition to a low-carbon energy system.</p> <p>Planning of the transmission system and procurement of new generation are currently done in isolation, i.e. modelling first assumes a certain build-out path including grid expansion. New generation capacity is procured on this basis. Creating a closer link between transmission grid build-out and auctions for generation capacity can contribute to an optimal expansion of the system overall.</p>
Electricity grids
<p>PRODESEN identifies priority areas for grid expansion on the basis of planned generation build-out. CENACE also proposes plans for cost-effective grid expansion. Factoring in non-generation options in transmission planning, such as demand response options, will help to minimise overall system costs.</p>
Uptake of innovative technology
Smart technologies uptake
<p>With the significant improvement in distributed grid infrastructure and the reduction of technical and non-technical losses, Mexico can follow through with its current planned strategy for a smart grid, being aware of innovation in other markets that could be readily adopted in Mexico. National investment in R&D in electricity grid planning and operation can have a relevant impact if associated with specific problems faced by the grid operator and distributors.</p>
Uptake of smart technologies
<p>Current legal and regulatory frameworks may be adjusted to allow the participation of storage facilities (such as batteries and/or pumped hydropower storage) and the demand side in the wholesale market and the provision of ancillary services. This should be promoted actively as a way to contain potential cost from rapid growth in solar and wind energy deployment.</p>
Resource-efficient technologies
<p>The long-term auctions for procuring VRE capacity signal the time- and location-dependent value of electricity while providing long-term investment certainty. Continuously improving the underlying power system models and sharing all relevant assumptions and modelling equations will help ensure that investments are guided accurately and also rely on actual market signals provided by hourly locational marginal prices.</p>
Efficiency and sector coupling
<p>Mexico's climate commitment under the Paris Agreement and the General Law on Climate Change entail a significant change in energy efficiency efforts, and a structural transformation of energy demand, including the growth of cross-sector electricity demand. Ensuring that investment in new sectors (industry, cooling and transport) consider system flexibility needs will assist in achieving higher shares of clean energy cost effectively.</p>

Australia

General overview of Australia's power sector

With a landmass of more than 7.5 million square kilometres and fewer than 25 million inhabitants, Australia is amongst the least densely populated countries in the world. The population is concentrated in the coastal areas, with very large distances between settlements. As a result, the national power system is divided into multiple systems without physical interconnections.

Due to the extremely long distance between the eastern and western states, Australia has two electricity markets: the National Electricity Market (NEM) in the east and the Wholesale Electricity Market (WEM) in the west. Market operations of the NEM and WEM are independent and the two systems are not physically connected due to the thousands of kilometres distance between them.

Australia's generation mix is dominated by coal, although its share in the mix has declined in previous years due to an increase in natural gas-fired generation and, most recently, increases in wind and solar photovoltaics (PV) (Figure 6.10).

This overview will focus on the NEM system, which is the largest interconnected power system in Australia, accounting for around 85% of the country's electricity demand.

Figure 6.10 • Electricity generation by fuel type and VRE share, 2005-15, Australia

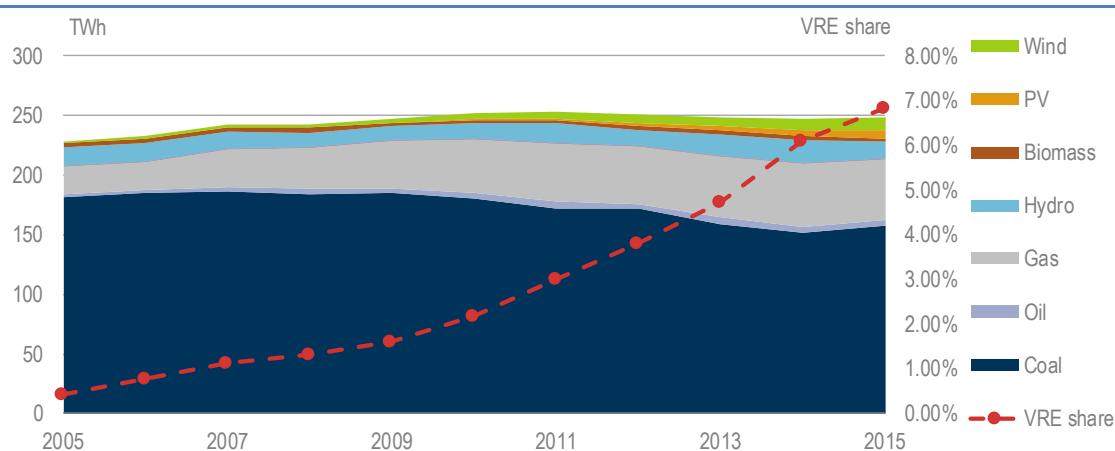

Note: PV includes residential, commercial and utility-scale systems.

Source: IEA (2017a), *World Energy Statistics 2016*.

Key point • Australia's energy system has experienced rapid growth of VRE sources in the last ten years.

The NEM is a fully interconnected transmission system covering the states of Queensland, New South Wales, Victoria, South Australia and Tasmania. The NEM is a wholesale electricity market operated by the Australian Energy Market Operator (AEMO), and is divided into five regions, corresponding to state borders.

The NEM transmission network is unique due to its long distances, low density and long, thin structure, which stretches over 4 500 kilometres (km) in distance. Over 330 generators produce electricity for sale into the market, which is physically linked by a transmission grid covering the five states (Figure 6.11). At the end of 2015, the NEM had approximately 47.6 gigawatts (GW) of installed capacity, of which coal accounted for around 54%, followed by gas at 20% (AER, 2016).

Recent years have seen a rapid increase in wind and solar PV generation due to technology cost reductions and policy support.

The current installed capacity in the NEM for large-scale wind and solar PV is 4 GW and 242 megawatts (MW) respectively, with around 5 GW of rooftop solar PV (AEMO, 2017a). While the share of VRE generation has increased to around 7%, it is concentrated in South Australia where its share reaches more than 40% of total generation in the state.

The Renewable Energy Target (RET) is an Australian government scheme that mandates the production of 33 terawatt hours (TWh) of renewable energy (or 23.5% of the electricity mix) by 2020. The RET is a quota obligation (put on suppliers) that is fulfilled via tradable certificates. There is also a Small-Scale Renewable Energy Scheme, providing investment grants for small-scale solar PV systems.

Figure 6.11 • Transmission network in the NEM

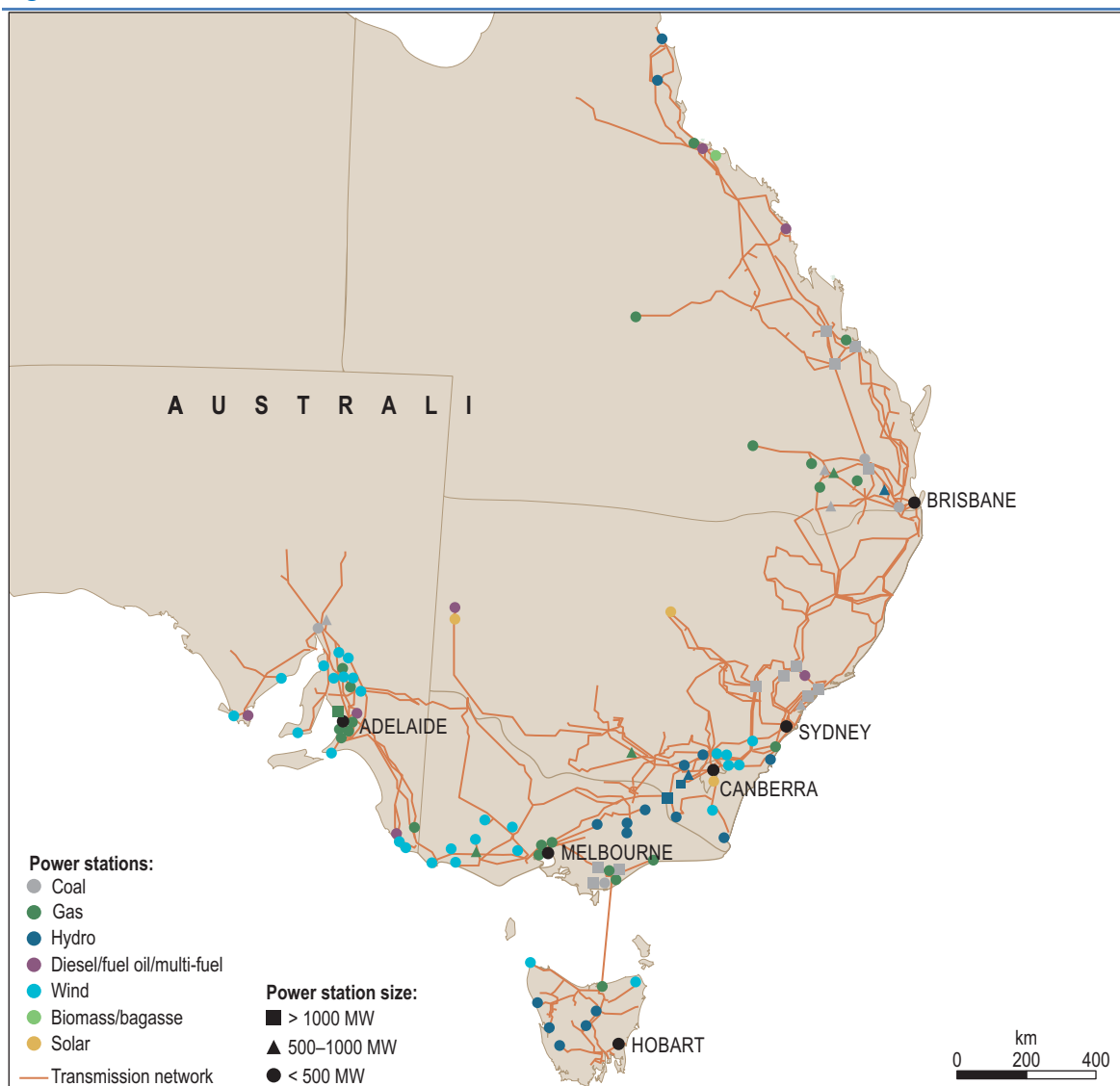

This map is without prejudice to the status of or sovereignty over any territory, to the delimitation of international frontiers and boundaries and to the name of any territory, city or area.

Source: AER (2016), *State of Energy Markets 2015*.

Key point • The NEM system spans for 4 500 km, providing electricity in five Australian states.

The federal structure of Australia has important implications for the governance of the electricity system. The primary responsibility for energy – and thus electricity – rests with the states and territories. An important mechanism for co-ordinating between different jurisdictions is the Council of Australian Governments (COAG) Energy Council, which brings together state and Commonwealth (federal) governments. Because the Commonwealth government has limited direct remit for electricity, a nationally aligned approach to any given issue is likely to require a consensual decision in the COAG. For example, it was the COAG that decided to task Australia's chief scientist, Dr Alan Finkel, to carry out an independent review into Australia's energy security following the 28 September event (Finkel, 2017).

Reflecting the complex governance situation, the establishment of the NEM was a long process that involved states handing over responsibility for the market to dedicated institutions. Three main institutions oversee the NEM:

- The Australian Energy Market Commission (AEMC) is responsible for making the rules and overseeing market development.
- The Australian Energy Regulator (AER) is responsible for economic regulation and rule enforcement.
- The Australian Energy Market Operator (AEMO) is responsible for operating Australia's gas and electricity markets. This includes maintaining a required amount of electricity in reserve, co-ordinating how the generated electricity is dispatched, and determining the spot price and financial settlement of the market.

Reflecting the governance of the system, individual states have recently announced ambitious renewable energy targets or already operate state-specific procurement mechanisms for renewable energy. It is not clear in all cases how state-level and federal targets relate, i.e. whether state targets are additional to, or in support of, federal targets.

The electricity landscape in Australia is undergoing a rapid transformation with increasing share of non-synchronous generation and increased uptake of distributed energy resources (DER). The changing generation mix and demand patterns have security and reliability implications for the existing power system.

System integration has received considerable attention, following a state-wide blackout in South Australia on 28 September 2016. During a severe storm the system experienced a sequence of six voltage disturbances within two minutes, triggering disconnection of approximately 450 MW of wind generation (which was supplying around half of generation at the time). This in turn led to a loss of synchronism between South Australia and the remaining grid, requiring the shutdown of the Heywood interconnector. After this, operating as a synchronous island with a low amount of inertia in the system, frequency dropped too quickly for under-frequency load shedding schemes to trigger in time, leading to a collapse of electricity supply across the entire South Australian system.

As an immediate response to the blackout event, AEMO introduced operational constraints to ensure sufficient levels of synchronous inertia and grid strength in South Australia, and wind farms have been reconfigured to withstand sequences of voltage disturbances. Following the events, questions of grid code design and power system stability at high shares of non-synchronous generation have featured prominently in the policy debate. In response, AEMO has published a series of incident reports to provide detailed information on the blackout. These highlight a number of key challenges, measures and recommendations for mitigating the risk of major supply disruption in South Australia. In addition, AEMC and AEMO have been engaging in a process to review market frameworks for system security.

Market and operations

Wholesale level

The NEM is an energy-only market where participation is mandatory for market generators and they must sell all of their electricity through the market (“gross pool market”). AEMO classifies generators as either market or non-market. A market generator must sell all the electricity it sends out through the market and receive payments from AEMO at spot market prices. A non-market generator sells its entire electricity output to a local retailer or customers and does not receive payment from AEMO. Energy retailers are the main customers in the wholesale market. They bundle electricity with network services such as distributing, metering and billing, for sale to residential, commercial and industrial energy users.

AEMO further classifies market and non-market generators into:

- **Scheduled generators:** aggregate generation capacity over 30 MW (predominantly coal and hydro power plants).
- **Semi-scheduled generators:** aggregate generation capacity over 30 MW with variable output (predominantly wind power plants).
- **Non-scheduled generators:** aggregate generation capacity between 5 and 30 MW.

Power plants with nameplate capacity of less than 5 MW may be exempted from being registered with AEMO as generators. The exempted power plants are considered as part of the demand side (as a negative load). About 52% of wind farms in the NEM system are currently semi-scheduled generators, with the remainder non-scheduled generators (AEMO, 2016a; PNNL, 2016).

Scheduled and semi-scheduled generators must offer to supply the market with specified amounts of electricity at specified prices for set time periods. Three possible types of bid are available: daily bids, rebids and default bids.

The submission period for daily bids for the next trading day closes at 12:30 each day. The generators’ dispatch offers must contain bids for each of the 48 daily trading intervals (30 minutes long) for the entire next day, the volume of energy to be dispatched and up to 10 price corrections in case of different dispatch level. Ramping capabilities must also be included in the dispatch offers.

Generators may submit rebids up until approximately five minutes prior to dispatch. With rebids, generators are allowed to change the volumes, but not the offer prices. Default bids are standing bids that apply where no daily bid has been made.

Six dispatch prices are averaged every half hour to determine the spot price for each NEM region (AEMC, 2017; AEMO, 2011, 2010).

Bulk power system operations

The NEM has a sophisticated generation dispatch process. Generators are dispatched in quasi-real-time (five minutes ahead) in five-minute intervals. Based on the generator offers submitted and transmission network parameters, AEMO performs central dispatch optimisation using software called the NEM Dispatch Engine (NEMDE). The dispatch process maximises the value of trade, subject to a number of constraints including transmission grid limitations.

Quasi-real-time dispatch allows last-minute fluctuation in weather conditions to be taken into account, in order to allow effective dispatch of VRE generators even if some of them are not

directly visible to AEMO. The short dispatch intervals allow for more accurate representation of variations in VRE output and, subsequently, net load.

With regard to visibility and control, semi-scheduled and non-scheduled generators are only required to inform AEMO of their technical properties (available capacity, ramping etc.). Semi-scheduled generators are also required to provide real-time data. AEMO can curtail semi-scheduled generation if necessary for system security reasons.

Ancillary services are used by AEMO for managing the security and reliability of the power system. These services consist of standards for frequency, voltage, network loading and system restart processes, which are provided in separate ancillary service markets. Frequency regulation services are provided by generators via automatic generation control (AGC). AEMO continually monitors the system frequency and sends control signals out to generators, providing regulation in such a manner that the frequency is maintained within the normal operating band (AEMO, 2015).

The NEM has put in place VRE forecasting systems in response to the rise of VRE generation. The Australian Wind Energy Forecasting System (AWEFS) and the Australian Solar Energy Forecasting System (ASEFS) are used to provide weather and VRE production forecasting, for timeframes from five minutes to two years. They take into account plant-level static data (plant details, historical meteorological measurements) and dynamic data provided by real-time supervisory control and data acquisition (SCADA) measurements of VRE plants. AEMO hosts the systems and maintains their interface with the existing market system, to feed information for the five-minute ahead dispatch orders (Figure 6.12).

Figure 6.12 • Wind forecasting system as part of the dispatch processes in the NEM

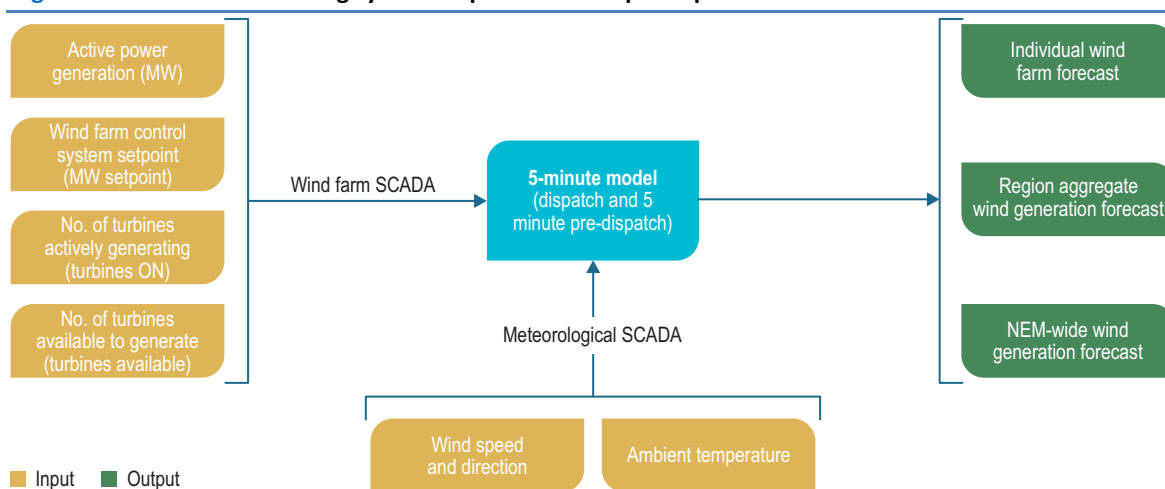

Source: Adapted from AEMO (2016b), *Australian Wind Energy Forecasting System (AWEFS)*.

Key point • The AWEFS feeds valuable quasi-real-time information to the dispatch centres, which alter the five-minute dispatch orders accordingly.

Different regions in the NEM are connected via high-voltage alternating current (AC) and direct current (DC) interconnectors. Directions of interconnector flows are influenced by the demand-supply balance in each region. The interconnectors in the NEM are subject to regulation, except the Bass link, which connects Victoria and Tasmania. Regulated interconnectors are eligible to receive a fixed annual revenue regardless of their usage, since they are deemed to add net market value to the NEM. An unregulated interconnector, on the other hand, derives revenue by trading in the spot market between regions.

Technical requirements for generators in the NEM are established under the National Electricity Rules (NER). However, it appears that the current provisions have not been recently updated to account for the rise in the share of generation provided by VRE. The technical connection requirements for South Australia are under review at present (AEMO, 2016b; ESCOSA, 2016).

The rules that comprise the NER are not made explicitly for VRE; rather they apply to all generators (although additional requirements are applied in South Australia through licensing conditions). There are concerns that existing grid code requirements may not be appropriate to facilitate the rising shares of VRE (IRENA, 2016). More precise technical requirements for generators, particularly VRE, are likely to be necessary to maintain system security, as reflected in the events leading up to the 28 September blackout described above.

To address operational challenges arising from the changes to the generation mix, AEMO has established the Future Power System Security (FPSS) program, which seeks to identify opportunities for and challenges to power system security and stability. High priority challenges that have been identified by AEMO comprise frequency control, system strength, extreme power system condition management and visibility of the power system (information, data and models) (AEMO, 2016c).

Electricity market framework

In the NEM, the maximum spot price (or market price cap) is currently set at USD 10 700 per megawatt hour (MWh) (AUD 14 000/MWh), and is adjusted annually for inflation. The minimum spot price (market price floor) is USD -765/MWh (AUD -1 000/MWh). The AEMC reviews the market price cap and market price floor definitions every four years to ensure they align with the NEM reliability standard. Being an energy-only market, the intent of the relatively high market price cap is to incentivise sufficient investment (IEA, 2017b).

In addition to the wholesale trading process already described, the NEM also has competitive spot markets for frequency control ancillary services (FCAS). There are eight real-time FCAS markets: two regulation markets (regulation raise and regulation lower), and six contingency markets (6-second raise and lower, 60-second raise and lower, and 5-minute raise and lower).³¹ These services can be provided by generators or by large interruptible load registered with AEMO. During each dispatch interval of the market, AEMO enables a sufficient amount of each of the eight products, from the bids submitted, to meet the system requirement via a co-optimisation.

With regard to demand-side participation, “The Power of Choice” review conducted in 2013 suggested the introduction of a demand response mechanism in the ancillary market. The rules drafted in 2016 allow customers’ loads to participate in the FCAS markets (IEA, 2017b).

A number of measures are currently under discussion to address the rising share of variable generation in the system. These include the possible introduction of a new ancillary service with a quicker response time (fast frequency response) or requiring resources to provide synchronous inertial response. GE (2017) provides a discussion of the possible technical solutions to the challenges associated with low system inertia.

Retail level

Retail markets and the role of distribution grids in Australia are changing rapidly due to uptake of distributed energy resources, particularly small-scale solar PV systems.

³¹ Regulation services are continually used to correct for minor changes in the demand/supply balance. Contingency services are only occasionally used to cover contingency events, although the services are always enabled.

Local grid operations

The low- and medium-voltage (up to 66 kilovolt [kV]) grids are managed by the distribution network system providers (DNSPs). Several DNSPs operate in each transmission region in Australia and can be state owned or privately owned. The DNSPs' primary role is to ensure a safe and reliable supply of electricity to consumers. Under this role, the DNSPs have no mandate to actively manage the upstream or downstream flows of electricity, or to provide forecasts to AEMO regarding the load or unscheduled generators' production.

The exchange of data between AEMO and the DNSPs is ensured via the transmission network service providers (TNSPs)³² and is based on energy flows at the connection points between DNSPs and TNSPs. AEMO forecasts residential and business consumption using information from previous five-minute dispatch periods, extrapolated from historical behaviour, considering weather conditions, the hour and the day of the week. Information on the location of small-scale solar PV plants is available to AEMO for those plants that receive support under the Small-Scale Renewable Energy Scheme. AEMO aims to increase its interaction and data exchange with the DNSPs in the future, as the presence of distributed energy sources increase (AEMO, 2017b).

Given the shift toward greater residential solar PV in the grid and the emergence of new business models, the role of the DNSPs is likely to change. Currently, the AEMC is conducting a distribution market model project to explore how the operation and regulation of distribution networks may need to change to accommodate increased uptake of DER (AEMC, 2016).

In the NEM, most residential and small business customers, other than in Victoria, have manually read accumulation or interval meters. These meters are provided by the DNSPs as a regulated service. Nearly all customers in Victoria have a smart meter following a Victorian Government mandate. The Victorian Government committed to the Advanced Metering Infrastructure Program in 2006, and the rollout was largely completed by December 2013.

New rules, which introduce competition in metering services, will be in force in 2017, which removes the current role of DNSPs in providing basic meters for residential and small business customers. Retailers will be responsible for arranging metering services. The new rules require that all new meters are capable of delivering a set of minimum services, such as remote reading, connection and disconnection. The new metering rules will increase visibility and control, and are expected to result in improved system operation as well as, possibly, more conscious demand management in the residential sector (IEA, 2017b).

Retail market frameworks

Although consumers are allowed to choose their electricity supplier, retail markets in the NEM remain fairly concentrated, with three large generator-retailers ("gentailers") accounting for more than 70% of small electricity customers (AER, 2016).

Electricity retail prices for residential and small business customers have been deregulated in Victoria, South Australia, New South Wales and South East Queensland, while they remain regulated in the other regions. Most retailers in the deregulated markets are currently privately owned.

Retail tariff structures and prices vary by contract, DNSP and supplier; each tariff, however, includes fixed and variable charges. Fixed charges apply to all connected customers in a distribution zone irrespective of their energy consumption. They amount to between 10% and 20% of the average retail tariff, varying by retailer. In Queensland, customers can also opt to be

³² TNSPs are five state-based network businesses that manage the transmission grid for each state, linking generators to the DNSPs.

subject to a demand charge during peak periods in summer, to obtain lower fixed and variable charges.

Except in South Australia, retailers also offer time-of-use (TOU) options (with day/night tariffs, up to four time periods per day and/or seasonal differentiation). Most consumers remain on accumulation meters, limiting their ability to opt for TOU tariffs; however, an imminent rule change on the rollout of smart meters should enable more consumers to opt for TOU schemes, or other more sophisticated schemes.

Network charges account for around 50% of the average residential bill. Since 2014, the AEMC has required DNSPs to set more advanced network tariff structures that better reflect individual consumers' grid usage, in order to allow consumers to make better-informed decisions about their use of electricity. Network tariffs are based on the long-run marginal cost of providing the service; if consumers decide to reduce their peak demand, they are rewarded with lower network charges. With most consumers remaining on accumulation meters, this provision is still not fully applied (IEA, 2017b).

Planning and infrastructure development

Integrated planning frameworks

Electricity planning in the NEM is not fully integrated, although a number of documents link long-term electricity planning in the NEM, including the following:

- The Energy White Paper (EWP) provides a long-term vision for the energy policy framework set out by government. The most recent EWP was released in 2015, and is the fourth EWP. The first three EWPs were released in 1998, 2004 and 2012 respectively. The 2015 EWP emphasises the role of markets (Commonwealth of Australia, 2015). It does not focus on the generation mix, instead forecasting new mechanisms for achieving effective competition in the energy sector.
- The National Energy Productivity Plan (NEPP) 2015-30 sets a target of achieving a 40% energy efficiency improvement by 2030 across the whole country, from 2015 levels, setting out the means by which to achieve greater energy efficiency.
- The National Transmission Network Development Plan (NTNDP) provides an independent and strategic view of the expansion of the electricity infrastructure in the NEM over a 20-year period, based on a number of credible scenarios. The NTNDP is further discussed below.
- The Electricity Statement of Opportunity (ESOO) provides ten-year outlook of supply adequacy under a number of scenarios. The document provides technical data and market information that inform the decision making of market participants and jurisdictional bodies when assessing opportunities in the NEM.
- The National Electricity Forecasting Report (NEFR) provides forecasts of electricity consumption and maximum and minimum demand for the NEM over the next 20 years under a number of different scenarios.

The NTNDP, ESOO and NEFR are issued by AEMO as annual reports, updated according to recent developments. They are loosely connected to each other, sharing the generic national targets on renewable energy and the emission reduction targets set out in Australia's commitment at the 21st Conference of the Parties in Paris (COP21).

Individual states have developed their own energy plans. A federal government-backed integrated energy plan may help the Australian government meet the COP21 emission reduction targets in a cost-effective and holistic way.

Electricity grid planning

The main electricity grid planning process in the NEM occurs under the NTNDP, which is an annual process. The NTNDP scenarios are prepared using PLEXOS software.³³

The planning of the transmission network in Australia appears not to be fully integrated, since transmission planning is carried out by independent TNSPs in each state. Although AEMO publishes its NTNDP each year, it is largely based on the aggregation of plans from the TNSPs. It emphasises the importance of the states adopting a co-ordinated approach to grid planning, due to the variety of potential interventions in the NEM and the interdependencies between state transmission systems.

The 2016 NTNDP takes steps to better co-ordinate and integrate transmission network planning with other elements. It takes into account Australia's COP21 commitment, the federal Large-Scale Renewable Energy Target, and the Victorian Renewable Energy Target. It also attempts to better accommodate larger shares of VRE generation, and suggests a series of practical interventions in the transmission grid to avoid transmission congestion and to improve system resilience.

Demand-side participation, electric storage and thermal storage are considered in the NTNDP scenarios. Furthermore, the 2016 NTNDP highlights the importance of geographic and technical diversity among generation assets, which smooths variability and reduces reliance on mid-merit generation (AEMO, 2016d).

Uptake of innovative technologies

The NEM is experiencing significant changes due to the uptake of VRE generation and other DER. The government has pursued significant work to ensure that regulatory frameworks support and appropriately accommodate technological change, including policy reviews and the countrywide roll-out of smart meters starting in 2017. However, it also recognises that further assessment is required to ensure these frameworks remain sufficiently flexible to meet these challenges. Key priorities include ensuring consumers can confidently take advantage of new technologies through the introduction of appropriate consumer protections, and ensuring the stability and connectivity of the NEM.

Smart technologies

The importance of digitalisation is well recognised by AEMO, which advocates enhanced visibility of DER and distribution-level consumption, and the establishment of frameworks for the collection of data to optimise operational procedures (IEA, 2017b).

Flexible resources

AEMO expects the strong uptake of VRE to continue and this will increase the need for system flexibility, particularly in South Australia where there is already a large share of VRE. Together with a number of other factors, the growing share of VRE is changing the energy supply mix in the NEM and the role of existing thermal plants (Box 6.2).

³³ PLEXOS is a commercial energy market simulation package with capabilities for modelling power system operation and planning. It contains over 150 technical and economic characteristics, which can be defined for each individual generation asset. Simulations can be produced over different timeframes, ranging from long-term generation capacity expansion to short-term dispatch and unit commitment.

Currently, AEMO has no visibility of distributed (up to 5 MW) battery storage within the power system, and therefore does not include this new technology in its operational demand forecasts.

The AEMC's "Power of Choice" review recommended a number of changes to the NEM to improve the incentives and opportunities for demand-side participation in the NEM. Energy ministers subsequently submitted rule change proposals to the AEMC, relating to:

- Distribution network pricing, intended to improve cost-reflective pricing of network services.
- Competition in metering, intended to support a market-led deployment of advanced meters.
- Giving consumers better access to their energy data.
- Introducing a demand response mechanism in the wholesale market. The AEMC decided not to progress with the demand response mechanism, but did improve the access of demand-side resources to ancillary services markets.

This demand-side integration is an important step towards the transformation of power system, to a point where load will be able to follow the generation profiles (IEA, 2017b).

Following the 28 September blackout in South Australia and capacity shortages during a countrywide heat wave in early 2017, a number of storage projects and plans have been announced by state and federal governments (Guardian, 2017; Ars Technica, 2017).

Box 6.2 • Implications for the changing role of coal plants in Australia

Coal is the dominant fuel source for electricity generation in the NEM. However, most of the existing coal plants have been in operation for more than 20 years and many are now reaching their expected lifespan of around 40 to 50 years. These coal plants are likely to be retired rather than refurbished. The most significant retirement was the Hazelwood power station with 1 600 MW capacity, which was built during 1960s and was one of the least efficient power stations in the country. The last unit at Hazelwood was shut down in March 2017.

New investment in coal-fired power plants is unlikely in Australia due to high cost of capital and risk arising from the reputational damage of emissions-intensive investments (BNEF, 2013). Retirement of conventional capacity can present challenges for power system operation due to an increased share of non-synchronous generation. New generation capacity is likely come from wind and gas-fired power plants. Therefore it is important that new and existing generating plants are installed and operated in a system-friendly manner to provide the flexibility to accommodate the needs of the power system.

Resource-efficient technologies

Solar PV systems are the main form of distributed generation currently installed in Australia. Government subsidies and state feed-in tariffs (FITs), combined with rising electricity prices, encouraged almost 1.5 million Australian householders to install solar PV systems between 2009 and 2015. Installed solar PV capacity reached 3 700 MW in the NEM in 2014/15, equivalent to 8% of total installed generation capacity, and supplied 2.7% of the total electricity consumed in that year.

AEMO expects the strong uptake of solar PV to continue, estimating 20 GW of installed capacity in the NEM by 2035/36, providing 14% of electricity consumption.

TOU tariffs can be used to incentivise the more system-friendly deployment of residential PV. Electricity costs peak during the evening and therefore time-dependent tariffs may encourage the installation of west-facing panels (instead of north-facing). This aligns the PV generation

profile with typical residential use (at the expense of total energy generation) and thus with peak residential energy prices (AEMO, 2016e).

One important aspect of the Australian VRE generation fleet is the concentration of the plants in certain regions, such as South Australia. Technology and a better geographical spread of VRE capacity provide an opportunity to reduce the impacts of variability and uncertainty caused by variable generation.

Efficiency and sector coupling

Electrification of the transport sector

To date, no direct incentive for EVs has been put in place in Australia. The federal luxury car tax (paid by businesses that sell or import luxury cars) is applied to vehicles valued over a certain threshold (USD 49 352 [AUD 64 132] in 2016/17). This threshold is higher for energy-efficient vehicles such as EVs (up to USD 58 120 [AUD 75 526] in 2016/17), but this does not provide a strong incentive for the purchase of EVs. Certain state and territory governments offer a concession on stamp duty or vehicle registration charges for EVs and/or vehicles with low CO₂ emissions. Despite their potential impact on demand forecasts, AEMO presently has no visibility of charging stations for EVs.

Electrification of heating and cooling

The RET scheme provides incentives for the electrification of the heating and cooling sector. One renewable energy certificate equates to 1 MWh of electricity generated by eligible renewable energy power stations, or energy displaced by solar water heaters or heat pumps. For simplification, the certificates for small-scale projects are issued in advance based on the estimated amount of energy the system will generate or displace over its lifetime, thus providing an investment incentive instead of a production incentive. During 2015, the scheme incentivised the installation of 8 898 heat pumps and 42 525 solar water heaters (CER, 2016).

The deployment of heat pumps, together with the expected deployment of residential smart meters, is an effective way to trigger demand shaping in the residential sector.

Energy efficiency

The National Energy Productivity Plan (NEPP) is the main document establishing energy efficiency policies. It endorses a 40% improvement in productivity³⁴ up to 2030 and is due to meet 25% of Australia's Intended Nationally Determined Contribution (INDC). Harmonisation of state energy efficiency schemes is being progressed under the NEPP.

Electricity demand projections for Australia have far exceeded actual demand in recent years. Indeed, after a peak in 2009, AEMO consistently forecast an imminent increase in consumption, which never materialised. A number of factors are contributing to this trend, including restructuring of Australian industry and increases in energy efficiency. A further factor is that AEMO accounts for distributed solar PV as a negative load and therefore the uptake of distributed PV is shown as a reduction in demand. It is questionable the extent to which this practice will facilitate planning of the overall power and energy system in light of the rapidly growing contribution from rooftop solar PV installations.

³⁴ "Productivity" is, in this case, defined as the opposite of energy intensity, and is therefore expressed in units of gross domestic product per unit of energy consumed.

AEMO also forecasts that a combination of energy efficiency and rooftop solar PV will change the pattern of *grid-level* summer demand. Maximum summer demand for electricity is forecast to occur later in the day and not grow over the next 20 years. Measures to cope with the misalignment between solar PV production and air conditioning utilisation may therefore assist in avoiding steeper power system ramping.

Summary and main observations

Table 6.5 • Key attributes and options for Australia

Market and operations
Wholesale level
<p>Generators are dispatched in quasi-real time (five minutes before actual generation), via a re-optimisation that takes into consideration an array of economic and technical factors. Quasi-real-time dispatch enables adjustment to short-term fluctuations in weather conditions, in order to allow effective dispatch of VRE generators.</p> <p>Precise technical requirements for generators, both VRE and non-VRE, will play an important role in maintaining system security at high shares of VRE. In this way, VRE generators should be able to participate in the provision of system services.</p>
Retail level
<p>Given the shift towards greater residential solar PV in the grid and the emergence of new business models, the role of the DNSP is changing.</p> <p>The reform of network charges and the smart meter rollout that is due to occur will allow more conscious demand-side management (DSM) in the residential sector. Smart meters will enable more residential consumers to choose TOU tariffs, which can help to bring down demand during peak hours.</p> <p>Reform of distribution grid tariffs and institutional arrangements to increase co-ordination between transmission and distribution can be key to a greater uptake of DER.</p>
Planning and infrastructure development
Integrated planning frameworks
<p>The future of Australia's energy sector is planned in a number of documents. These plans are loosely connected to each other, most sharing the generic national targets on renewable energy and the COP21 emission reduction targets. Individual states have also developed their own strategic plans, which are independent of other states'. A federal government-backed integrated energy plan may help the Australian government to meet the COP21 emission reduction targets in a cost-effective and holistic way.</p>
Electricity grids
<p>Planning of the transmission network in Australia appears to be loosely integrated, since it is carried out by TNSPs in each state. However, the NTNDP, which is published annually, does attempt to aggregate and co-ordinate network planning between states by providing an independent, strategic view of the efficient development of the national transmission grid. Further emphasising the whole-system approach to the plan may increase its effectiveness.</p>
Uptake of innovative technology
Smart technologies
<p>From December 2017, smart meters with a set of advanced services, which include remote reading and remote connection and disconnection, will be deployed. They will allow remote data gathering, which in turn will permit enhanced visibility of the power system to AEMO.</p> <p>Data gathering and system visibility are considered crucial aspects of power system transformation to accommodate greater VRE and guarantee a continued safe, secure and reliable supply of electricity to consumers.</p>
Flexible resources
<p>No major policies currently incentivise the deployment of electric storage; government-backed research and development (R&D) activities are in place to analyse the impact of these technologies on the grid.</p> <p>The AEMC took a number of measures to trigger demand-side response and management, thus setting the scene for a more flexible power system, which will be able to accommodate higher shares of VRE. Mobilising demand-side flexibility appears to be an important priority for ensuring cost-effective evolution of the system.</p>

Resource-efficient technologies

Policies and market and regulatory frameworks to encourage the technological and geographical diversity of VRE deployment can smooth aggregated output, reducing flexibility requirements and delaying the need for grid reinforcements.

Efficiency and sector coupling

Electrification of the transport sector

Currently, EVs do not benefit from dedicated policies. Policies to encourage the use of EVs and appropriate charging strategies would trigger the deployment of a potential source of flexibility in the power system.

Electrification of heating and cooling

Heat pumps are subsidised through the RET scheme. Encouraging TOU tariffs for heat pump owners may trigger effective demand shaping in the residential sector.

Energy efficiency

Australia aims to reach 25% of its COP21 targets through energy efficiency. Its energy efficiency plans are delineated in the NEPP, which foresees the use of demand-response and transparency in price signalling as means for the deployment of new energy technologies.

Linking energy efficiency measures with VRE deployment, in particular rooftop solar PV, may allow the benefits of both to be realised.

References

- Anditya C. (2017), "Indonesia's policy on power sector", Directorate of Electricity, Ministry of Energy and Mineral Resources, presentation at IEA, Paris.
- AEMC (2017), *National Electricity Rules*, Version 90, Australian Energy Market Commission, www.aemc.gov.au/getattachment/b1cf4294-7128-49fc-a25b-dcf81afce93/National-Electricity-Rules-Version-89.aspx.
- AEMC (2016), *Distribution Market Model: Approach Paper*, Australian Energy Market Commission, Melbourne.
- AEMO (Australian Energy Market Operator) (2017a), "Generation information page", www.aemo.com.au/Electricity/National-Electricity-Market-NEM/Planning-and-forecasting/Generation-information (accessed 19 March 2017).
- AEMO (2017b), *Visibility of Distributed Energy Resources*, www.aemo.com.au/-/media/Files/Electricity/NEM/Security_and_Reliability/Reports/AEMO-FPSS-program---Visibility-of-DER.pdf.
- AEMO (2016a), *Visibility of the Power System*, www.aemo.com.au/-/media/Files/Electricity/NEM/Security_and_Reliability/Reports/AEMO-Fact-Sheet_Visibility-of-the-Power-System---Final.pdf.
- AEMO (2016b), *Australian Wind Energy Forecasting System (AWEFS)*, www.aemo.com.au/-/media/Files/PDF/Australian-Wind-Energy-Forecasting-System-AWEFS.pdf.
- AEMO (2016c), *Future Power System Security Program*, www.aemo.com.au/Electricity/National-Electricity-Market-NEM/Security-and-reliability/FPSS-Reports-and-Analysis.
- AEMO (2016d), *National Transmission Network Development Plan for the National Electricity Market*, www.aemo.com.au/-/media/Files/Electricity/NEM/Planning_and_Forecasting/NTNDP/2016/Dec/2016-NATIONAL-TRANSMISSION-NETWORK-DEVELOPMENT-PLAN.pdf.

- AEMO (2016e), *National Electricity Forecasting Report*, www.aemo.com.au/Electricity/National-Electricity-Market-NEM/Planning-and-forecasting/-/media/080A47DA86C04BE0AF93812A548F722E.ashx.
- AEMO (2015), *Guide to Ancillary Services in the National Electricity Market*, www.aemo.com.au/-/media/Files/PDF/Guide-to-Ancillary-Services-in-the-National-Electricity-Market.ashx.
- AEMO (2011), *Spot Market Operations Timetable*, www.aemo.com.au/media/Files/Other/electricityops/0100-0014%20pdf.pdf.
- AEMO (2010), *An Introduction To Australia's National Electricity Market*, www.abc.net.au/mediawatch/transcripts/1234_aemo2.pdf.
- AER (2016), *State of Energy Markets 2015*, Australian Energy Regulator, Melbourne.
- Ars Technica (2017), "Australian leaders pledge funds for energy storage after billionaire Tweet bet", <https://arstechnica.co.uk/tech-policy/2017/03/australian-leaders-pledge-funds-for-energy-storage-after-billionaire-tweet-bet/>.
- Bischof-Niemz, T., J. Calitz and J. G. Wright (2016), *Benefits of Solar PV Reserve Provision in South Africa*, Southern African Solar Energy Conference, www.sasec.org.za/full-papers/48.pdf.
- BNEF (2013), *Renewable Energy Now Cheaper than New Fossil Fuels in Australia*, Bloomberg New Energy Finance website, www.bloomberg.com/news/articles/2013-02-06/australia-wind-energy-cheaper-than-coal-natural-gas-bnef-says.
- CENACE (Centro Nacional de Control de Energía) (2016), *Informe que Presenta Transparencia Mexicana A.C. Como Testigo Social en el Procedimiento de Subasta de Largo Plazo* [report presented by Transparencia Mexicana A.C. on the long-term auction procedure], CENACE, Largo, www.cenace.gob.mx/Docs/MercadoOperacion/Subastas/2016/42%20Informe%20Transparencia%20Mexicana%20SLP01-2016%20v2016%2010%2006.pdf.
- CENACE (2015), "Manual de Pronósticos – Anteproyecto de fecha 24 de septiembre de 2015" [Forecasts Manual – draft dated 24 September 2015], public consultation draft, CENACE, Mexico City.
- CER (2016), *2015 Administrative Report and Annual Statement*, Clean Energy Regulator, www.cleanenergyregulator.gov.au/DocumentAssets/Documents/The%20Renewable%20Energy%20Target%202015%20Administrative%20Report.pdf.
- CNN (2015), *Bos PLN Tak Punya Rencana Hapuskan Listrik Prabayar* [PLN does not abolish prepaid electricity plan], CNN Indonesia, www.cnnindonesia.com/ekonomi/20150909160227-85-77670/bos-pln-tak-punya-rencana-hapuskan-listrik-prabayar/.
- Commonwealth of Australia (2015), *Energy White Paper 2015*, Australian Government.
- CRE (2016), "Código de Red" [Grid Code], *Diario Oficial de la Federación*, Comisión Reguladora de Energía, Mexico City.
- CSIR (2016), *Wind and Solar PV Resource Aggregation Study for South Africa*, Council for Scientific and Industrial Research, CSIR Energy Centre, Pretoria.
- CSIR (2013), "How to stimulate the rooftop PV market in RSA without putting munics' profit at risk", presentation, Council for Scientific and Industrial Research, Johannesburg.
- DLA (2017), *New Indonesian Feed-in Tariffs*, DLA Piper, www.dlapiper.com/en/france/insights/publications/2017/03/new-indonesian-feed-in-tariffs/.
- ESCOSA (Essential Service Commission of South Australia) (2016), "Inquiry into licensing arrangements under the Electricity Act 1996 for inverter-connected generators",

- www.escosa.sa.gov.au/projects-and-publications/projects/inquiries/inquiry-into-licensing-arrangements-for-inverter-connected-generators.
- Eskom (2017), *Small and Micro-Generation Connection Framework*, webpage, www.eskom.co.za/Whatweredoing/Pages/SmallMicroGeneration-.aspx.
- Eskom (2016), *Demand Response*, Eskom, www.eskom.co.za/sites/idm/ManageYourConsumption/Pages/DemandResponse.aspx (accessed 04 January 2016).
- Eskom (2015a), *Schedule of Standard Prices for Eskom Tariffs 1 April 2015 to 31 March 2016 for Non-Local Authority Supplies, and 1 July 2015 to 30 June 2016 for Local Authority Supplies*, Eskom, Johannesburg.
- Eskom (2015b), *Transmission Development Plan 2016-2025*, Eskom, Johannesburg.
- Finkel, A. (2017), *Independent Review into the Future Security of the National Electricity Market*, Department of the Environment and Energy, Australian Government, www.environment.gov.au/energy/publications/energy-market-preliminary-report.
- GE (2017), *Technology Capabilities for Fast Frequency Response*, General Electric Consulting, report prepared for AEMO, www.aemo.com.au/-/media/Files/Electricity/NEM/Security_and_Reliability/Reports/2017-03-10-GE-FFR-Advisory-Report-Final---2017-3-9.pdf.
- Guardian, The (2017), "South Australia to build battery storage and gas-fired power plant in \$550m energy plan", www.theguardian.com/australia-news/2017/mar/14/south-australia-to-build-battery-storage-and-gas-fired-power-plant-in-550m-energy-plan.
- IEA (International Energy Agency) (2017a), *World Energy Statistics 2016*, OECD/IEA, Paris.
- IEA (2017b), *Australian Response to the Energy Policy In-Depth Review*, questionnaire with local energy sector experts, OECD/IEA, Paris.
- IEA (2017c), *Global EV Outlook 2017*, OECD/IEA, Paris.
- IEA (2016a), *Next Generation Wind and Solar Power* (full report), OECD/IEA, Paris.
- IEA (2016b), "Overview and description of recent developments in energy policy", in-depth review questionnaire with local energy sector experts, OECD/IEA, Paris.
- IEA (2015a), *Energy Policies Beyond IEA Countries: Indonesia 2015*, OECD/IEA, Paris.
- IEA (2015b), *Development Prospects of the ASEAN Power Sector*, OECD/IEA, Paris.
- IRENA (2016), *Scaling up Variable Renewable Power: The Role of Grid Codes*, www.irena.org/DocumentDownloads/Publications/IRENA_Grid_Codes_2016.pdf.
- LBNL (2015), *Water Heater Technical Study to Improve MEPS – South Africa*, Lawrence Berkeley National Laboratory, Berkeley.
- LBNL (2013), *Energy Efficiency Country Study: Republic of South Africa*, Lawrence Berkeley National Laboratory, Berkeley.
- MEMR (2007), "Peraturan menteri energi dan sumber daya mineral nomor: 03 tahun 2007" [Regulation of the Minister of Energy and Mineral Resources No. 03/2007], Ministry of Energy and Mineral Resources, Jakarta.
- NERSA (2015), "Small-scale embedded generation: Regulatory rules", consultation paper, February 2015, National Energy Regulator of South Africa, Pretoria.

- NERSA (2014), *The South African Grid Code – The Scheduling and Dispatch Rules*, National Energy Regulator of South Africa, Arcadia.
- PLN (2016a), *Rencana Usaha Penyediaan Tenaga Listrik (RUPTL 2016-2025)* [Electricity Supply Business Plan (RUPTL 2016-2025)], PT PLN (Persero), Jakarta.
- PLN (2016b), *Statistik PLN 2015* [PLN Statistics 2015], PT PLN (Persero), Jakarta.
- PNNL (2016), *Integrating Renewable Generation into Grid Operations*, Pacific Northwest National Laboratory, www.pnnl.gov/main/publications/external/technical_reports/PNNL-25331.pdf.
- PPIAF (2014), *South Africa’s Renewable Energy IPP Procurement Program: Success Factors and Lessons*, Public Private Infrastructure Advisory Facility, Washington, DC.
- PQRS (2017), online database, Power Quality and Renewable Services, www.pgrs.co.za (accessed 29 March 2017).
- SA DEA (2016), “Cabinet approves gazetting of Renewable Energy Development Zones”, press release, South Africa Department of Environmental Affairs, Pretoria, www.environment.gov.za/mediarelease/cabinet_gazetting_redz.
- SA DOE (2015), “South Africa’s energy situation”, in Energy Advocacy, May 2015, South Africa, Department of Energy, www.energy.gov.za/files/media/Pub/Energy-Advocacy-May2015-Issue-1-newsletter.pdf.
- SA DOE (2011), *Integrated Resource Plan for Electricity 2010-2030*, South Africa, Department of Energy, Pretoria.
- SENER (2017), *Cuestionarios Anuales de la Agencia Internacional de Energía* [International Energy Agency Questionnaires], Secretaría de Energía, Mexico City.
- SENER (2016a), *Reporte de Avance de Energía Limpia 2015* [Progress Report on Clean Energy 2015], Secretaría de Energía, www.gob.mx/cms/uploads/attachment/file/118995/Informe_Renovables_2015_2.pdf.
- SENER (2016b), *Programa Especial de Transición Energética*, [Special Programme for Energy Transition], Edition under Regulatory Review, Secretaría de Energía, www.cofemersimir.gob.mx/mirs/41798.
- SENER (2016c), *Manual de Interconexión de Centrales de Generación con Capacidad Menor que 0.5 MW* [Interconnection Manual for Power Plants with Capacity up to 0.5 MW], Secretaría de Energía, www.cofemersimir.gob.mx/portales/resumen/41183.
- SENER (2016d), *Programa de Desarrollo del Sistema Eléctrico Nacional 2016-2030 (PRODESEN)* Secretaría de Energía, Mexico City.
- Shah, M. et al. 2016, *Clean Restructuring: Design Elements for Low-Carbon Wholesale Markets and Beyond*, National Renewable Energy Laboratory, www.nrel.gov/docs/fy16osti/66105.pdf.

Annex A. Details of technical measures to address power system challenges

Introduction

This annex provides details of the reliability and economic measures mentioned in Chapter 3 that have been used to address challenges in power system operation arising from VRE generation. The annex focuses particularly of measures that are employed during the later phases of VRE deployment (Phases 3 and 4).

Technical measures during the later phases of VRE deployment

Tools and techniques for enhancing transmission line capacity

Dynamic line rating

Dynamic line rating (DLR) calculates the capacity of transmission lines closer to real time by taking into account actual operating and ambient conditions instead of assuming a fixed capacity.

Typically, a transmission line is rated at a certain capacity to carry power. The capacity of a line is usually constrained by line sag, which happens due to current-related temperature increase. The conventional approach for determining the capacity of transmission lines is based on the worst-case assumptions (low wind speed, high ambient temperature, high solar radiation) (IEA, 2014). The line capacity determined under this assumption would then be used across a range of actual conditions. However, the actual ability of a line to carry power is influenced by temperature: at lower temperatures, the real capacity of the line is likely to be higher than the rating.

DLR allows flows in transmission lines to be well above the static rating for most of the time.³⁵ With DLR, system operators (SOs) can make use of additional capacity when available and thus reduce the need for network investment. At times of high winds and, in some cases, high levels of solar power generation, DLR can be an effective option to alleviate transmission congestion and thus reduce the risk of curtailment.

DLR has been implemented to great effect in many systems including, for example, Spain, the United Kingdom, Ireland, Texas and Australia (Box A.1) (US DOE, 2012). The impact of DLR depends on system-specific circumstances.

Recently, the US Idaho National Laboratory has been developing a software package to calculate real-time ampere capacity and thermal limit of transmission lines (INL, 2017). This tool uses power flow and weather information at sparsely located weather stations, rather than having a device physically attached to a line. It will enable SOs to accurately assess dynamic real-time limitation and adjust power production accordingly. This method may prove to be more cost-effective compared to traditional DLR.

³⁵ Taking into account a gentle wind of 1 metre per second can increase the line rating by as much as 44% (Aivaliotis, 2010). In many systems, DLR can be 30% higher than static line rating for 90% of the time (US DOE, 2012).

Box A.1 • DLR in the Snowy Region, Australia

DLR has been implemented by TransGrid, who is a transmission network service provider (TNSP) in New South Wales, in order to maximise transmission capacity and reduce the risk of congestion. The system utilises weather data that are monitored and recorded in real time by weather stations. These real-time data enable TransGrid to understand the conditions the line is experiencing and therefore manage and operate it more efficiently.

TransGrid expected high levels of wind generation to cause much of the future congestion in the 330 kilovolt (kV) transmission lines between the Snowy Region and Sydney. It is deploying DLR projects to assist in reducing potential congestion by allowing higher thermal limits that result from high wind speed. According to the Australian Energy Market Operator, DLR should make it possible to increase power transfer on the 330 kV transmission lines between the Snowy Region and Sydney by approximately 400 megawatts (MW)

Source: AEMO (2014), *Independent Planning Review: Attachment A – Transgrid Project Assessment Reports*.

Flexible alternating current transmission system devices

Flexible alternating current transmission system (FACTS) devices are high-power electronics-based technologies offering real-time controllability – their main benefit is to enhance transmission efficiency and reliability.³⁶ They are used to enhance controllability of the network, power system stability and increase power transfer capability at key points in the transmission grid. The condition of the network can be controlled by FACTS devices in a fast and flexible manner.

In this way, FACTS devices allow for better utilisation of the existing network by enabling transmission lines to be operated closer to capacity without causing disturbances in the system. They can help to address issues of network congestion that may be caused by VRE.

The effectiveness of a FACTS device depends on its type and rating, as well as on local network conditions. Utility-scale FACTS device applications have been implemented to manage congestion in a number of countries, including the United States, the United Kingdom, Japan, Thailand and Sweden. Experiences suggested that a FACTS device installed on the network can significantly enhance transmission capacity (Gupta et al., 2017). They have also been used to accommodate the integration of large balancing areas by enhancing the transfer capability of interregional interconnectors, particularly between Nordic countries, allowing greater shares of VRE to be deployed in the region.

Phase shifter

A phase shifter is used to improve the transfer capacity of existing transmission lines by controlling the direction and magnitude of power flow in specific lines of the network.³⁷ It is considered an economic and reliable approach to managing power flow using existing assets.

Phase shifters are important components in alternating current (AC) transmission networks. They can be used to control active power flow at the interface between two large and solid

³⁶ There are two main groups of FACTS device: thyristor-based and voltage source converter-based FACTS. The most common type of FACTS devices are Static VAR Compensator (SVC), Thyristor Controlled Series Capacity (TCSC), Static Synchronous Compensator (STATCOM), Static Synchronous Series Compensators (SSSC) and Unified Power Flow Controllers (UPFC).

³⁷ The basic function of a phase shifter is to control active power by adjusting the phase displacement between the input and the output voltage of a transmission line.

independent networks, and have increasingly been used to manage power transfers in systems and reduce bottlenecks in the grid caused by VRE power injection.

Advanced VRE technologies and design

Higher direct current to alternating current ratio for solar PV plants

The production limit for a solar PV plant (in AC terms) is dictated by the inverter size. As the output level of a solar array (in direct current [DC] terms) reaches the rated peak capacity only during a certain number of hours, depending on the climate, the nominal capacity of the solar array will generally exceed the inverter capacity by at least 10% (NREL, 2014).

The ratio between the nominal capacity of the solar array and the inverter size is referred to as the DC/AC ratio, or the inverter load ratio (ILR). A solar PV plant with a higher DC/AC ratio can run at full capacity more often than a plant with a lower DC/AC ratio. Although PV plants with a larger solar array face larger clipping losses,³⁸ at the same time they gain “additional” energy production during the shoulder hours.

The optimal DC/AC ratio is driven by a number of factors, such as the technical obligations prescribed by the grid code, the relative cost of solar panels to inverters, and the cost of connecting plants. Once the connection capacity (i.e. the size of the inverter) is set, the solar array size is optimised. The rapid decrease in PV module costs in recent years has supported the trend to install larger solar arrays in certain countries.

Higher DC/AC ratios for solar PV plants are increasingly evident in countries such as United States due in part to exposure to time-dependent revenue streams, which favour a higher DC/AC ratio if midday energy has a lower value.

In California, for example, time-of-delivery (TOD) factors have been used in power purchase agreement (PPA) prices, favouring solar PV production in the late afternoon (Figure A.1). In the current system, TOD factors are determined on the basis of the net load profile. Because net load is particularly low when solar PV production is at its peak, California’s Pacific Gas and Electric Company (PG&E) midday TOD adjustment for March to June in 2016 resulted in payment of only 28% of the standard PPA price. Exposure to real-time spot prices can have a similar effect.

Figure A.1 • Examples of utility TOD factors in California

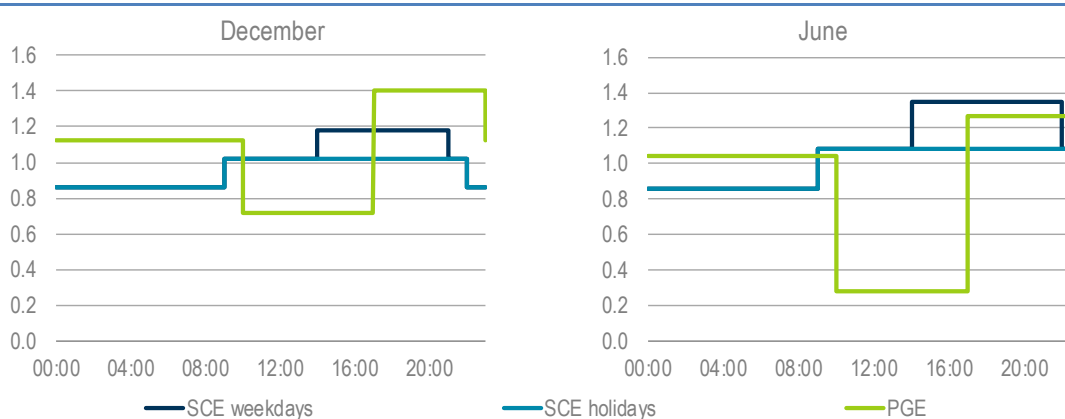

Note: SCE = South California Edison.

Source: Adapted from SCE (2015), *2015 Pro Forma Renewable Power Purchase Agreement*; PG&E (2015), *Renewables Portfolio Standard: 2015 Solicitation*.

Key point • Prices in California favour solar PV output in the late afternoon.

³⁸ Clipping losses are the amount of solar energy that is lost during the solar peak hours, because the inverter cannot manage the full peak production.

Changing orientations and tilt angle of solar PV panels

Solar PV panels in the northern hemisphere have traditionally been installed with a south-facing orientation in order to maximise electricity production. However, a westward orientation can shift peak production to later in the day when it has more value to utilities in many jurisdictions. This is because the solar generation profile corresponds better with the demand profile of the grid (Hartner et al., 2015).

Page | 144

In California, the Energy Commission has provided financial incentives for west-facing solar energy systems in PG&E, SCE, and San Diego Gas and Electric Company territories to encourage solar PV production at a time when electricity demand is greatest, in the late afternoon (CEC, 2014).

However, this change in orientation can reduce the total output from solar PV systems, presenting a trade-off between total energy losses and the value of a shift in the time of production to utilities.

Advanced wind turbine technology

Advanced wind turbine technology (“low wind speed turbines”) results in turbines that are taller and have a larger rotor per unit of generation capacity. This means that the turbine has a larger area with which to catch wind for each unit of generation capacity compared to the classical technology. They therefore produce a higher output at moderate wind speeds. This tends to make output less variable as compared to classical turbines (Figure A.2).

An additional benefit of advanced wind turbines is that they can be effective even when they are not installed at locations where wind resources are at their highest, yielding more value from economic and system operation perspectives. This enables wind power plants to be built across different geographical locations and smooth out the net variability of overall wind output.

Figure A.2 • Generation output profiles of classical versus advanced wind turbines

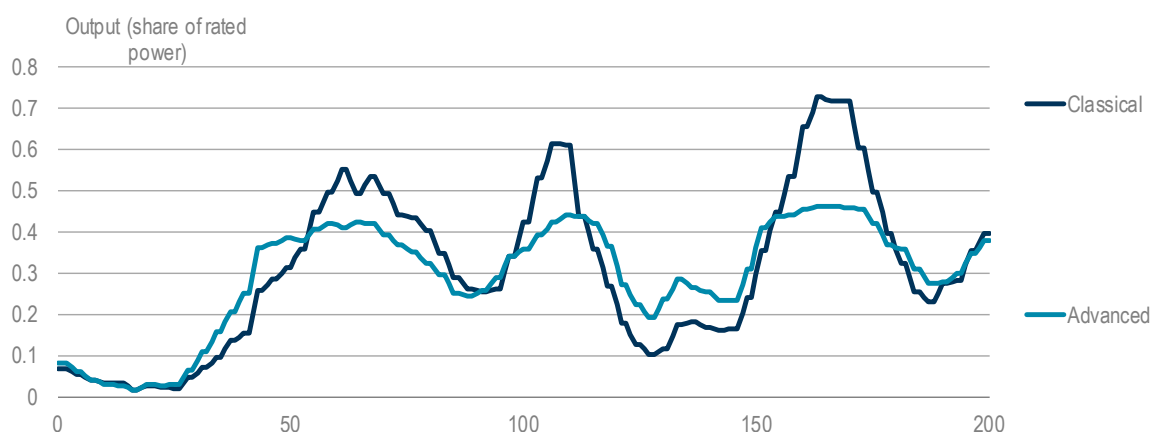

Source: Hirth and Mueller (2016), “System-friendly wind power: How advanced wind turbine design can increase the economic value of electricity generated through wind power”.

Key point • Advanced wind turbines have a more stable output and produce more power during periods of moderate wind availability.

Box A.2 • Denmark's feed-in premium scheme to incentivise more advanced wind turbine technologies

Denmark's latest revision to its premium system for wind power plants has been designed to promote the use of larger rotors per unit of installed generation capacity. The amount of energy that is eligible for support payments is set at 6 600 megawatt hours (MWh) for the project lifetime per MW of installed capacity, plus an additional 5.6 MWh for each square metre of rotor swept area. Consequently, installing a larger rotor on a wind turbine will result in higher overall support payments.

The design of the Danish feed-in premium system provides a direct incentive for advanced wind turbines, resulting in more stable and thus system-friendly power production.

Establish a limit on system non-synchronous penetration

System non-synchronous system penetration (SNSP) needs to be set in line with overall system performance levels, i.e. a limit that is appropriate in one system may be too high or too low in another system of the same size. The SNSP limit indicates the maximum share of non-synchronous generation, at any instance, that does not pose a security risk to the power system. This is considered a reliability measure.

Establishing the limit of SNSP requires in-depth studies, which typically involve detailed dynamic simulations of the power system at different demand levels and generation dispatches, taking into account expected development in the system. It is important to note that an SNSP limit is system specific and has to be established based on thorough analysis and testing.

Ireland/Northern Ireland have the most advanced systems for developing multi-year work programmes to integrate high levels of VRE into the power system. As part of this work, the two transmission system operators (TSOs) were able to identify and project the SNSP limit, increasing it from 50% to 75% by 2020 (Box A.3).

Box A.3 • Ireland's work programme for establishing a maximum SNSP limit

Eirgrid and SONI (System Operator Northern Ireland), which are the TSOs in Ireland and Northern Ireland respectively, have been undertaking studies to address the challenges of integrating high share of VRE onto the power system since 2010. The studies indicated that an SNSP below 50% would allow the system to operate in a reliable and efficient manner following a disturbance or frequency event. The issues identified include high rate of change of frequency (RoCoF) as a result of low synchronous inertia and transient stability.

As part of the "Delivering a Secure Sustainable Electricity System (DS3)" work programme, Eirgrid and SONI aim to gradually increase the SNSP limit from 50% to 75% by 2020. The work programme has identified pathways for achieving high SNSP (Figure A.3); these include the development of enhanced operational practice, system services arrangements (such as inertia, reserve, ramping, transient voltage and voltage regulation), additional control centre tools and additional investment in network infrastructure.

The work programme is well on track to achieving an SNSP limit of 75%. Since December 2016, Eirgrid has raised the SNSP limit to 60% and has experienced 64 consecutive hours with a maximum SNSP greater than 55%.

Source: Eirgrid/SONI (2016), *DS3 Programmed Operational Capability Outlook 2016*.

Figure A.3 • Projections of SNSP in Ireland/North Ireland

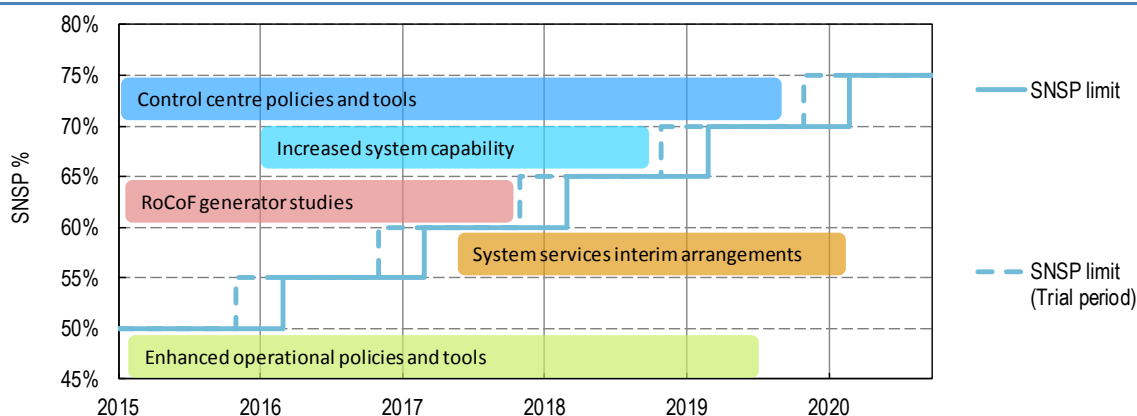

Source: Adapted from Eirgrid/SONI (2016), *DS3 Programmed Operational Capability Outlook 2016*.

Key point • A clear plan can help to identify options for increasing the share of VRE in the power system.

Inertia-based fast frequency response

Since modern VRE generators are connected to the grid via a power converter device, VRE generators only respond to deviations in system frequency according to the configuration of their power electronics. Reliably detecting a frequency event, extracting inertia from wind turbines, and managing the “re-charging” of the rotational energy of the turbine through the wind therefore requires sophisticated tuning of a synthetic inertia controller.

If appropriately tuned, inertia-based fast frequency response (IBFFR) can reduce the amount of synchronous inertia required by the grid. Note, however, that IBFFR cannot directly replace synchronous inertia provided by conventional generating units due to the fundamentally different characteristics in the nature of their response to high RoCoF events (Eirgrid/SONI, 2015).³⁹

The TSO in Quebec, Canada, has established technical requirements for physical inertia from wind power plants since 2006 (Box A.4), while Brazil and Ontario are considering similar mandates. In the middle of 2017, the National Electricity Market (NEM) in Australia will also be conducting a major trial in South Australia, where the share of VRE is around 40%, for a wind power plant to provide IBFFR. The trial will involve a new wind power plant to demonstrate its ability to provide fast frequency response to the system.

Box A.4 • Requirements for wind turbines to provide IBFFR in Quebec

The transmission grid of Quebec is relatively small, with a peak power demand lower than 40 000 MW. The loss of generation can cause a severe threat to system security. In 2005, the Canadian TSO, Hydro-Québec TransÉnergie, set requirements for synthetic inertia from wind turbines by introducing a new grid code. Since then, wind turbines are required to deliver a power boost equal to 6% of their rated capacity in situations where system frequency drops. The time of response is 1.5 seconds for the maximum power contribution and should last at least 9 seconds. This led to wind turbine manufacturers to develop new technical solutions. In case of a frequency deviation, it is possible to extract kinetic energy from the rotating mass of a wind turbine.

³⁹ It is important to recognise the trade-offs between the response provided and the recovery period, where active power from the wind turbines reduces temporarily. During this recovery period, the output from wind turbines can decrease by as much as 30% for as long as 40 seconds (DGA Consulting, 2016). This can create an adverse impact on the system’s frequency recovery.

In actual contingency events, wind turbines show a response within 1 to 2 seconds, with an active power increase of 6% to 10% of rated capacity, which extends for about 10 seconds. Wind turbines of various types (from a number of different manufacturers) have been shown to successfully deliver this response.

A low-frequency event in December 2015 showed that this enables about 126 MW of extra synthetic inertia to support the system. Due to a transformer failure, around 1 700 MW of generation disconnected from the system, when total demand was around 31 000 MW. Total remaining wind generation was around 2 060 MW and about 50% of the operating turbines were able to provide additional inertia of 126 MW. Although the frequency dropped to 59.1 hertz (Hz), it is estimated that it would have dropped up to 0.2 Hz more without the additional inertia from wind turbines.

Source: Asmine, M., C. Langlois, and N. Aubut (2016), "Inertial response from wind power plants during a frequency disturbance on the Hydro-Quebec System – Event analysis and validation".

Smart inverter

State-of-the-art smart inverters can provide five specific functions: ramp rate control, Volt/VAR (volt-ampere reactive) control, high-frequency power curtailment, voltage and frequency ride-through and grid monitoring. The electrical characteristics of inverters can be modified through software controls and parameter settings.

The use of smart inverters, whether at utility- or small-scale, may not be necessary during the initial phases of VRE deployment. However, at high shares of VRE, smart inverters can play an important role in facilitating the integration of VRE. Cost differences between smart and conventional inverters are not significant. Hence, smart inverters are starting to become common for new VRE installations even at a low share of VRE. Puerto Rico provides an example of the rollout of smart inverters (Box A.5).

Box A.5 • Smart inverter rollout in Puerto Rico

Puerto Rico has an ambitious plan to reduce the fossil-fuel intensity of its power system by installing 1 gigawatt (GW) of renewable energy into its 5.8 GW capacity system, with a peak demand of around 4 GW (NREL, 2015; IRENA, 2013). Being an island, the availability of external supply is limited for Puerto Rico. Among the requirements that the Puerto Rico Electric Power Authority (PREPA) has placed on new VRE plants is the capability to regulate real and reactive power output, as well as requiring a number of grid-friendly controls.

Solar photovoltaics (PV) operators complied with the grid codes by installing smart inverters with VAR control and fault ride-through capability, and by installing battery storage systems in parallel with PV plants.

Source: NREL (2015), *Energy Snapshot: Puerto Rico, Energy Transition Initiatives*; IRENA (2013), *Smart Grids and Renewables: A Guide for Effective Deployment*.

Advanced pumped hydropower operation

Certain pumped storage hydropower plants can operate in a special mode called hydraulic short-circuit pumped storage (HSCPS),⁴⁰ with the main feature of simultaneously generating and

⁴⁰ This operation mode is possible in ternary pumped storage units where a separate turbine and pump is located on a single shaft with an electrical machine that can operate in generator or motor mode. The electrical motor and generator is a synchronous machine.

pumping. It enables the plant to contribute to system inertia and frequency regulation. If the plant is operating in either generator or pump mode, it is capable of switching between operation modes very quickly, without having to reverse the rotation.⁴¹

The ability to simultaneously operate in both turbine and pump mode provides greater flexibility to the grid. The power plant is seen by the grid as controllable load, with a power regulation range equal to that of hydropower turbines in operation. The contribution to inertia depends on the inertia of the unit, while frequency regulation depends on the turbine response.

HSCPC has been in operation in hydropower plants in Austria, Switzerland, the Canary Islands and Wales (Cavazzini and Perez-Diaz, 2014; Koritarov and Guzowski, 2013).

Grid-level storage

The different fundamental storage mechanisms can be broadly classified into electrical, mechanical, chemical and electromechanical, each of which consists of different technology types. Storage technologies vary greatly in terms of size, response time and charging/discharging times, and more importantly their capacity to provide system services to the grid.

The PJM market in the Northeastern United States has been at the forefront of deploying storage technologies to provide fast frequency response (FFR). Through its incentive mechanisms, FFR assets such as batteries and flywheels receive higher revenues per MW for regulation compared to fossil fuel power plants. As of 2016, PJM has about 250 MW of electricity storage (excluding hydro) that is currently in operation (Glazer, 2016).

Other countries that have deployed grid-level storage to provide frequency response include Italy and Chile. In Italy, more than 40 MW of electric storage has been deployed, consisting of different kinds of storage technologies including lithium-ion (Li-ion) batteries, super-capacitors and sodium-sulphur (NaS) in order to alleviate congestion and improve system inertia. Chile has also deployed batteries to provide frequency response (Box A.6).

Despite their benefits, storage technologies, other than pumped hydropower, generally remain expensive in many countries and therefore financial incentives must be provided. In addition, many power systems with high shares of VRE can still operate the grid reliably without the need for storage.

Box A.6 • Chile's grid level storage

In Chile, energy storage has been used to provide frequency response to maintain the security of the system. AES, which is a developer of advanced battery technology applications, has developed a storage solution to perform reserve capacity functions for grid support in Chile's systems. AES owns 4.5 GW of generation capacity in Chile and developed a solution using Li-ion batteries to meet part of the obligation to provide frequency response.

The battery units are programmed to sense frequency deviations and ramp to full output instantaneously to provide support to the local grid and restore frequency. The first grid storage project, with a storage capacity of 12 MW/4 MWh, was developed to operate in both dispatch and autonomous mode, responding directly to significant frequency deviations, from ± 0.3 Hz.

A specific example was during a loss of 640 MW of generation in the system in 2013. Two energy storage units rapidly injected 32 MW to arrest frequency decline, in conjunction with other system services, until other generators were brought online.

Source: Kumaraswamy, K. (2016), "Energy storage is the smart choice to meet primary frequency response needs".

⁴¹ The transition time between the mode of operation is in the range of 0.5 to 1 minute compared to 1.5 to 5 minutes in normal pumped storage (Koritarov and Guzowski, 2013).

References

- AEMO (2014), *Independent Planning Review: Attachment A – Transgrid Project Assessment Reports*, Australian Energy Market Operator.
- Aivaliotis, S. (2010), *Dynamic Line Ratings for Optimal and Reliable Power Flow: Enhanced Power Flow for the Smart Grid*, FERC Technical Conference, www.ferc.gov/CalendarFiles/20100623162026-Aivaliotis,%20The%20Valley%20Group%206-24-10.pdf.
- Asmine, M., C. Langlois, and N. Aubut (2016), “Inertial response from wind power plants during a frequency disturbance on the Hydro-Quebec System – Event analysis and validation”, 15th International Workshop on Large-Scale Integration of Wind Power, Vienna.
- Cavazzini, G. and J. Perez-Diaz (2014), *Technological Developments for Pumped Hydro Energy Storage*, Joint Programme on Energy Storage, European Energy Research Alliance (EERA).
- CEC (2014), *California Moves to Improve Solar Incentive Program for New Homes*, California Energy Commission.
- DGA Consulting (2016), *International review of frequency control adaptation: A report to the Australian Energy Market Operator (AEMO)*, DGA Consulting.
- Eirgrid/SONI (System Operator Northern Ireland) (2015), *DS3 RoCoF Alternative Solutions Phase 1 Concluding Note*, EIRGRID/SONI.
- Eirgrid/SONI (2016), *DS3 Programme Operational Capability Outlook 2016*, EIRGRID/SONI.
- Hartner, M. et al. (2015). “East to west – The optimal tilt angle and orientation of photovoltaic panels from an electricity system perspective”, *Applied Energy*, Vol. 160, pp. 94-107.
- Glazer, C. (2016), “Integrating energy storage in PJM: Growing market opportunities”, Energy Storage Conference, Argonne National Laboratory, 30-31 August.
- Gupta, M. et al. (2017), “Mitigating congestion in a power system and role of FACTS devices”, *Journal of Advances in Electrical Engineering*, Vol. 17, Hindawi Publishing Corporation.
- Hirth, L. and S. Mueller (2016), “System-friendly wind power: How advanced wind turbine design can increase the economic value of electricity generated through wind power”, *Energy Economics*, Vol. 56, pp. 51-63.
- IEA (International Energy Agency) (2014), *The Power of Transformation: Wind, Sun and the Economics of Flexible Power Systems*, OECD/IEA, Paris.
- INL (2017), “General Line Ampacity State Solver (GLASS) Factsheet”, Idaho National Laboratory, www4vip.inl.gov/research/general-line-ampacity-state-solver/ (accessed 05 May).
- IRENA (2013), *Smart Grids and Renewables: A Guide for Effective Deployment*, International Renewable Energy Agency.
- Koritarov, V. and L. Guzowski (2013), *Modeling Ternary Pumped Storage Units*, Argonne National Laboratory, Illinois.
- Kumaraswamy, K. (2016), “Energy storage is the smart choice to meet primary frequency response needs”, *IEEE SmartGrid Newsletter*, January.
- NREL (2015), *Energy Snapshot: Puerto Rico, Energy Transition Initiatives*, National Renewable Energy Laboratory, Golden.
- NREL (2014), *PVWatts Version 5 Manual*, National Renewable Energy Laboratory, Golden.

PG&E (2015), *Renewables Portfolio Standard: 2015 Solicitation*, Pacific Gas & Electric.

SCE (2015), *2015 Pro Forma Renewable Power Purchase Agreement*, Southern California Edison, https://scerps.accionpower.com/scerps_1501/documents.asp?Col=DateDown (accessed 04 March 2017).

US DOE (2012), *Dynamic Line Rating Systems for Transmission Lines*, Smart Grid Demonstration Program, US Department of Energy, www.smartgrid.gov/sites/default/files/doc/files/Global_Smart_Grid_Federation_Report.pdf.

Abbreviations and acronyms

AC	alternating current
ACER	Agency for the Cooperation of Energy Regulators
ADMS	advanced distribution management system
AEMC	Australian Energy Market Commission
AEMO	Australian Energy Market Operator
AER	Australian Energy Regulator
AGC	automatic generation control
ASEAN	Association of Southeast Asian Nations
ASEFS	Australian Solar Energy Forecasting System
AWEFS	Australian Wind Energy Forecasting System
CACM	capacity allocation and congestion management
CAES	compressed air energy storage
CAISO	California Independent System Operator
CEC	clean energy certificates
CECRE	Centro de Control de Energía Renovable (Control Centre of Renewable Energies)
CENACE	Centro Nacional de Control de Energía
CER	Clean Energy Regulator
CET	clean energy technologies
CFE	Comisión Federal de Electricidad (Federal Electricity Commission)
CRE	Comisión Reguladora de Energía (Energy Regulation Commission)
DAM	day-ahead market
DC	direct current
DER	distributed energy resources
DLR	dynamic line rating
DNSP	distribution system network providers
DSM	demand-side management
DSO	distribution system operator
EFR	enhanced frequency response
EIM	energy imbalance market
EMS	energy management system
EPC	energy production cost
ERCOT	Electric Reliability Council of Texas
ESMAP	Energy Sector Management Assistance Program
ETS	emissions trading scheme
EU	European Union
EV	electric vehicle
FACTS	flexible alternating current transmission system
FCAS	frequency control ancillary services
FCR	frequency control reserves
FERC	Federal Energy Regulatory Commission
FIT	feed-in tariff
FPSS	Future Power System Security
FRR	frequency restoration reserves
FRT	fault ride-through
HSCPS	hydraulic short-circuit pumped storage
HV	high voltage

IBFFR	inertia-based fast frequency response
ICT	information and communication technology
IEA	International Energy Agency
IFC	International Finance Corporation
IPP	independent power producer
IRENA	International Renewable Energy Agency
IRP	integrated resource plan
ISGAN	International Smart Grid Action Network
ISO	independent system operator
JAMALI	Java-Madura-Bali
LMP	locational marginal pricing
LV	low voltage
MEMR	Ministry of Energy and Mineral Resources
MISO	Midcontinent Independent System Operator
MV	medium voltage
NEM	National Electricity Market
NREL	National Renewable Energy Laboratory
NTNDP	National Transmission Network Development Plan
OCGT	open-cycle gas turbine
OECD	Organisation for Economic Co-operation and Development
ORDC	operating reserve demand curve
PECC	Programa Especial de Cambio Climático (Special Climate Change Programme)
PG&E	Pacific Gas and Electric Company
PLN	Perusahaan Listrik Negara
PNNL	Pacific Northwest National Laboratory
POSOCO	Power System Operation Corporation
PPA	power purchase agreement
PRODESEN	Programa de Desarrollo del Sistema Eléctrico Nacional (National Energy System Development Plan)
PRONASE	Programa Nacional para el Aprovechamiento Sostenible de la Energía (National Programme for the Sustainable Use of Energy)
PSH	pumped storage hydropower
PV	photovoltaic
PVPS	Photovoltaic Power Systems Programme
REDZ	Renewable Energy Development Zone
REE	Red Eléctrica de España
REIPPPP	Renewable Energy Independent Power Producer Procurement Programme
RTE	Réseau de Transport d'Électricité
RTM	real-time market
RUEN	Rencana Umum Energi Nasional (National Energy Master Plan)
RUKN	Rencana Umum Ketenagalistrikan Nasional (National Electricity Master Plan)
RUPTL	Rencana Usaha Penyediaan Tenaga Listrik (Electricity Supply Plan)
SAARC	South Asian Association for Regional Cooperation
SANEDI	South African National Energy Development Institute
SCADA	supervisory control and data acquisition
SCE	Southern California Edison
SENER	Secretaría de Energía
SHS	solar home system
SIN	Sistema Interconectado Nacional (National Interconnected System)
SNSP	system non-synchronous system penetration

SO	system operator
SPS	special protection scheme
TNSP	transmission network service provider
TOD	time of delivery
TOU	time of use
TSO	transmission system operator
TYNDP	Ten-Year Network Development Plan
USD	United States dollar
VRE	variable renewable energy

Units of measure

GW	gigawatt
GWh	gigawatt hour
Hz	hertz
km	kilometre
kmc	kilometre of circuit
kV	kilovolt
kW	kilowatt
kWh	kilowatt hour
MVA	megavolt ampere
MW	megawatt
MWh	megawatt hour
MW/hr	megawatts per hour
tCO ₂	tonne of CO ₂
TWh	terawatt hour
VAR	volt-ampere reactive

Online bookshop

www.iea.org/books

PDF versions at 20% discount

E-mail: books@iea.org

International Energy Agency



Secure Sustainable Together

Global Gas Security series

Energy Technology Perspectives series

World Energy Outlook series

Energy Policies of IEA Countries series

World Energy Investment series

Energy Statistics series

Oil

Energy Policies Beyond IEA Countries series

Gas

Coal

Renewable Energy

Energy Efficiency

Market Report Series

This publication reflects the views of the IEA Secretariat but does not necessarily reflect those of individual IEA member countries. The IEA makes no representation or warranty, express or implied, in respect of the publication's contents (including its completeness or accuracy) and shall not be responsible for any use of, or reliance on, the publication.

Unless otherwise indicated, all material presented in figures and tables is derived from IEA data and analysis.

This document, as well as any data and any map included herein are without prejudice to the status of or sovereignty over any territory, to the delimitation of international frontiers and boundaries and to the name of any territory, city or area.

IEA Publications,
International Energy Agency
Website: www.iea.org
Contact information: www.iea.org/aboutus/contactus

Typeset and printed in France by IEA, June 2017

Cover design: IEA. Photo credits: © PhotoObsession.

IEA/OECD possible corrigenda on: www.oecd.org/about/publishing/corrigenda.htm

