



OMAX®

JetMachining® Center User's Guide

OMAX Corporation
21409 72nd Avenue South
Kent, WA USA 98032

Information:
Fax:
Customer Service:
E-Mail:
Web:

253-872-2300 x3
253-872-7446
1-800-298-4036
techsupport@omax.com
<http://www.omax.com>



This document contains subject matter to which OMAX® Corporation has proprietary rights. Recipients of this document shall not duplicate, use, or disclose information contained herein, in whole or in part, for any use other than the purpose for which this manual was provided.

OMAX Corporation believes the information described in this manual is accurate and reliable. From time to time, design improvements will be made to the OMAX JetMachining Center. Photographs, text, and sketches within the body of this manual may not exactly represent your equipment. In general, this manual contains the most up-to-date information available. However, OMAX Corporation cannot accept any responsibility, financial or otherwise, for any consequences arising out of the use of this material. The information contained herein is subject to change, and revisions may be issued to advise of such changes or additions. OMAX strives to continually improve their user documentation. If you have any questions or concerns about the content of this service and maintenance guide, we want to hear from you. Please e-mail us at tech_writing@omax.com or contact us by mail at:

OMAX Corporation
Technical Publications
21409 72nd Avenue South
Kent, WA, USA 98032

OMAX Corporation is continually improving their equipment to bring you the best in abrasivejet machining technology. For that reason, your OMAX JetMachining Center may differ slightly from what is described in this document. If you have any questions, please feel free to contact us at 1-800-838-0343 or e-mail us at techsupport@omax.com. You can also receive technical support on-line at:
<http://www.omax.com/support> (user name and password required for access)

OMAX®, MAXJET®5, Intelli-MAX®, Tilt-A-Jet®, MAXJET4®, 2626|xp®, and JetMachining® are registered trademarks of OMAX Corporation.

Intelli-TRACE™ is a trademark of OMAX Corporation.

Windows® is a registered trademark of Microsoft Corporation

The OMAX Machine tool apparatus and linear motion track are covered by U.S. patent number 5,472,367.
The OMAX motion control with precompilation is covered by U.S. patent number 5,508,596.
Other patents pending.

Original instructions
September 2010
© 2010 OMAX Corporation

Contents

	Page
Chapter 1	
Safety First	
Safety Labels	1 - 1
Safety Precautions	1 - 4
Table Safety Requirements	1 - 4
Pump Safety Requirements	1 - 5
Equipment Safety Features	1 - 5
Emergency Stop Switch (E-Stop)	1 - 5
Overpressure Protection	1 - 5
Electrical Protection	1 - 5
Access Control Circuit	1 - 5
Lock-out/Tag-out Procedure	1 - 6
Disposing of Waste Materials	1 - 6
Adequate Shop Ventilation	1 - 6
OMAX JetMachining Center Safety Checklist	1 - 7
Chapter 2	
The OMAX JetMachining Center	
The OMAX JetMachining Center	2 - 1
Description of JetMachining Center Components	2 - 1
PC-based Controller	2 - 2
Front Panel	2 - 2
Control Panel Operator Switches	2 - 3
Internal PC-based Controller Components	2 - 3
Windows® PC	2 - 5
PC Rear Panel	2 - 5
X- Y- Z-axis Motion System	2 - 5
Abrasivejet Delivery System	2 - 7
Abrasivejet Nozzle	2 - 7
The Abrasive Hopper	2 - 8
High-pressure Plumbing	2 - 9
Swivels	2 - 9
The Dual ON/OFF Valve	2 - 10
Catcher Tank	2 - 10
Chapter 3	
Introduction to the OMAX Pump	
Description of the OMAX Pump	3 - 1
Pump Components	3 - 2
Pump Viewed from Front and Right Side	3 - 2
Front Pump View with Front Panel Removed	3 - 2
Rear Pump View with Rear Panel Removed	3 - 3
Top Pump View with Lid Opened	3 - 3
Pump Side View with Right Panel Open	3 - 4
Pump Control Panel	3 - 4
High-pressure Pump ON/OFF Switch	3 - 4
Charge Pump ON/OFF Switch	3 - 5
Emergency Stop Switch (E-stop)	3 - 5
Operator Keypad and Display Screen	3 - 5
Display Screen	3 - 5
Run Button	3 - 6
Stop Button	3 - 6
Reset Button	3 - 6
Up/down Arrow Buttons	3 - 6
Fault Messages	3 - 6
Pump Operating Characteristics	3 - 6
How the OMAX High-pressure Pump Works	3 - 7
How the OMAX Charge Pump Works	3 - 8
How the Pump's Electrical Circuits Work	3 - 9
Pump Specifications	3 - 11

Chapter 4

Operating the OMAX JetMaching Center

About Abrasivejet Machining	4 - 1
The OMAX Software	4 - 2
OMAX Layout Program	4 - 2
OMAX Make Program	4 - 2
OMAX Interactive Reference	4 - 3
Operating the High-pressure Pump	4 - 3
Start the Pump	4 - 3
Set the Pump RPM	4 - 4
Set the Adjustable Dump Orifice (ADO)	4 - 4
Stopping the Pump	4 - 8
Emergency Shutdown Procedures	4 - 8
Operating the JetMachining Center	4 - 8
Configure Your Drawing	4 - 8
Determine a Cutting Quality	4 - 9
Clamp and Position Your Materials for Cutting	4 - 9
Use Tabs for Holding Small Parts	4 - 10
Set Machine Limits	4 - 10
Cut Your Parts	4 - 11
Set Up the Hardware	4 - 11
Configure the Make Software	4 - 19
Cut the Material	4 - 19
Shutting Down the JetMachining Center	4 - 21
Ensuring Clean and Quiet Machining	4 - 22
Keep the Abrasivejet Nozzle Under Water	4 - 22
Place a Muff on the Abrasivejet Nozzle	4 - 22
Keep Extra Sponges on Hand	4 - 23
Washing Heavy Garnet Deposits from Parts	4 - 23
Tips for Effective Cutting	4 - 23
Startup Checkoff Sheet	4 - 25
Shutdown Checkoff Sheet	4 - 26

Chapter 5

OMAX Pump Maintenance

Consumable Pump Parts	5 - 1
Maintenance Schedules	5 - 1
General Maintenance	5 - 1
High-pressure Wet End Maintenance	5 - 2
Routine Maintenance Schedule	5 - 2
Less Frequent Maintenance Schedule	5 - 2
Minor Maintenance Detail	5 - 3
Major Maintenance Detail	5 - 3
Overhaul Detail	5 - 4
Maintenance Log	5 - 5
Maintenance of the Wet End Pump Assembly	5 - 6
Tools Required for Wet End Maintenance	5 - 6
Removing the High-pressure Wet End Assembly	5 - 8
Disassembling the Wet End Assembly	5 - 10
Inspecting the Backup-Support Ring Assembly	5 - 13
Inspecting the Liquid Displacers	5 - 14
Disassembling and Inspecting the Check Valve Assembly	5 - 15
Reassembling the Check Valve Assembly	5 - 18
Replacing the High-pressure Port Adapter Seals and Filter	5 - 21
Reassembly of the Pump Wet End Assembly	5 - 23
Replacing the Water Coolant Housing Seal	5 - 25
Removing Plunger Assemblies	5 - 26
Reinstalling Plunger Assemblies	5 - 28
Assembling the Dynamic Seal Assembly	5 - 28
Reassembling the Pump	5 - 29
Maintenance of the Water Filtration System	5 - 32
Changing Water Filter Cartridges	5 - 34
Cleaning the Pump White Water Tank	5 - 35
Changing Crankcase Oil	5 - 36
Maintaining the Pump Motor Belt	5 - 37
Lubricating the Electric Motor	5 - 38
Replacing the Electrical Enclosure Air Filters	5 - 40
Resealing the Safety Valve	5 - 40

Chapter 6

OMAX Table Maintenance

Maintenance Schedule	6 - 1
Maintenance Log	6 - 2
Tools Required for Table Maintenance	6 - 3
Maintaining the High-pressure Plumbing System	6 - 3
Creating a High-Pressure Seal	6 - 5
Using Blue Goop® Thread Lubricant	6 - 5
Assembling the UHP Fitting	6 - 5
Three Thread Rule	6 - 6
Working with High-Pressure Systems	6 - 6
Tank Maintenance	6 - 7
Cleaning Tips	6 - 7
Removing Garnet Accumulation	6 - 7
Solids Removal System Clean Out Software	6 - 8
Cleaning the Filter Screen for the Tank's Water Outlet	6 - 8
Controlling Tank Odor	6 - 8
Slat Replacement	6 - 9
Maintaining the X-Y Carriage Bellows	6 - 9
Timing Belt Inspection and Tensioning	6 - 10
Timing Belts for Cantilever Tables	6 - 10
Locating the Timing Belts	6 - 10
Inspecting and Adjusting Timing Belts	6 - 11
Timing Belts for Bridge-style Tables	6 - 12
Locating the Timing Belts	6 - 12
Adjusting Timing Belts: Y-axis	6 - 13
Adjusting Timing Belts: 80160 X-axis	6 - 13
Lubricating the JetMachining Center	6 - 14
Grease Fittings and Couplers	6 - 15
Identifying Lubrication Points	6 - 15
Lubrication Points for Cantilever Style X, Y Carriages	6 - 16
Greasing the X and Y Carriages	6 - 16
Lubrication Points for the Motorized Z-Axis	6 - 17
Greasing the Z-axis Bearings	6 - 17
Lubrication Points for Bridge Style X, Y Carriages	6 - 20
Lubricating the Y-axis Carriages for the 80160, 60120 and 80X	6 - 20
Lubricating the 80160 X-axis Rails	6 - 21
Lubricating the X-axis Rails for the 120X	6 - 23
Rebuilding the Abrasivejet Nozzle	6 - 24
Identifying When to Repair and Rebuild the Nozzle	6 - 24
Preparing for Nozzle Repair/rebuild	6 - 24
Removing a MaxJet® 5 Nozzle Assembly from a Tilt-A-Jet	6 - 25
Removing the Nozzle Mixing Tube	6 - 25
Removing the Nozzle Body from the Inlet Body	6 - 26
Removing the Filter Seal Assembly from the Inlet Body	6 - 26
Removing the Orifice Assembly	6 - 27
Removing the Mixing Chamber Disc	6 - 27
Removing the Mixing Chamber	6 - 27
Removing the Nozzle Body O-Ring	6 - 28
Cleaning and Inspecting Nozzle Components	6 - 28
Cleaning	6 - 28
Inspecting	6 - 29
Mixing Chamber Disc	6 - 30
Mixing Tube	6 - 31
Nozzle Filter Seal Assembly	6 - 32
Mixing Chamber	6 - 33
Reassembling the Nozzle Assembly	6 - 33
Nozzle Filter Seal Assembly	6 - 33
Mixing Chamber	6 - 34
Mixing Chamber Disc and Orifice Assembly	6 - 35
Nozzle Body	6 - 36
Mixing Tube	6 - 38
Nozzle Tests	6 - 39
Maximizing Nozzle Life	6 - 39
Removing and Reinstalling the Inlet Body on a Tilt-A-Jet	6 - 40
Cleaning the Inlet Body	6 - 43
Reinstalling the Inlet Body	6 - 43
Removing and Reinstalling a Mini-MaxJet 5 Nozzle Assembly	6 - 46
Disassembling a MiniJet Nozzle	6 - 46

Step 2: Remove the MiniJet Nozzle Body from the Inlet Body Extension	6 - 46
Step 3: Remove the Inlet Body Extension from the Inlet Body	6 - 47
Step 4: Remove the MiniJet Dummy Orifice from the Inlet Body	6 - 48
Step 9: Remove Ring Seals and O-Rings	6 - 48
Reassembling the MiniJet Nozzle Assembly	6 - 49
Mini-Maxjet 5 Installation and Operation	6 - 51
Installing the Mini-Maxjet 5	6 - 51
Operating the Mini-MAXJET 5	6 - 51
Rebuilding the Dual ON/OFF Valve	6 - 52
Removing the Dual ON/OFF Valve	6 - 52
Disassembling the Dual ON/OFF Valve	6 - 55
Reassembling the Dual ON/OFF Valve	6 - 56
Installing the Dual ON/OFF Valve	6 - 58
PC-based Controller Maintenance	6 - 59
Cleaning the OMAX Industrial Keyboard and Mouse	6 - 59
Cleaning the LCD Monitor Screen	6 - 59
Replacing the Cabinet Air Filter	6 - 60
Replacing the CMOS Battery	6 - 60
The role of the CMOS battery	6 - 60
What happens when the CMOS battery fails	6 - 60
Clues to a CMOS battery failure	6 - 60
Rebooting Windows	6 - 61
Running the Disk Defragmenter Utility	6 - 61
Upgrading Your OMAX Software	6 - 61

Chapter 7

Troubleshooting the OMAX Table

Troubleshooting the OMAX JetMachining Center	7 - 1
Problems	7 - 1
Abrasivejet Nozzle Doesn't Move	7 - 1
Parts are Too Short, or Flat Spots Appear When Cutting Curves	7 - 1
Home Position or Soft Limits are Lost	7 - 1
Poor Surface Finish	7 - 1
Holes Too Large and Undersized Parts	7 - 2
Excessive Taper on Part Edges	7 - 2
Holes are Not Round	7 - 2
Abrasivejet Not Piercing Material	7 - 2
Abrasivejet Quit Cutting	7 - 2
80160 Not Cutting Square Parts	7 - 2
Accuracy Errors	7 - 2
Water is Forced Up the Abrasive Tube	7 - 2
The Jet Looks Wide and Fuzzy	7 - 3
No Abrasive Flow	7 - 3
No Abrasive Flowing from the Abrasive Tube	7 - 3
Abrasive Material Pours Out the Top of the Abrasive Tube	7 - 3
Water Spurts Out of the Tank	7 - 3
Abrasive Piles Up on the Work Piece	7 - 3
The Table Has an Unpleasant Odor	7 - 3
Keyboard or Mouse Fail to Work	7 - 3
Blue Screen Errors	7 - 3
"Babysit Triggered" Message	7 - 3
Solutions	7 - 4
Correcting Water Leaks in the Nozzle Assembly	7 - 8
Correcting Water Leaks in the ON/OFF Valve	7 - 9

Chapter 8

Troubleshooting the OMAX Pump

Keypad Display Messages	8 - 1
Normal Operation Messages	8 - 1
Pump Fault Messages	8 - 1
Fault Message – "Charge Pressure Low"	8 - 2
Fault Message – "Charging Pump Contactor"	8 - 2
Fault Message – "Dead Head"	8 - 4
Fault Message – "Variable Drive Fault"	8 - 4
General Pump Problems	8 - 4
Low or Fluctuating Pump Output Pressure	8 - 5
No AC Power at Pump Unit	8 - 6
Pump Does Not Start	8 - 6
No Keypad Display	8 - 7



Fuses F1/F2 Blowing	8 - 8
Circuit Breaker CB1 Tripping	8 - 9
Pump Runs but Display Reads "0.3 KSI", or "0 KSI"	8 - 9
Correcting Water Leaks in the Wet End Assembly	8 - 10

Chapter 9

Customer Service

Contacting OMAX Customer Service	9 - 1
Ordering Parts	9 - 1
Returning Parts	9 - 1
Returned Material Procedures	9 - 1
Parts Ordered in Error	9 - 2
Unused Parts	9 - 2
Parts Shipped in Error	9 - 3
Parts Returned for Repair	9 - 3
Parts Returned for Warranty Repair or Replacement	9 - 3
Two Year Limited Warranty	9 - 4



Safety First

This chapter describes safety labels that may appear on your OMAX JetMachining Center. These labels provide information essential for safe equipment operation. This chapter also emphasizes important safety precautions that must be observed while operating or servicing and maintaining this equipment, and identifies the safety devices built into this equipment.

Safety Labels



Machine Safety



MANDATORY ACTION! Wear Gloves.

Bacteria in the tank water can build up. Even a seemingly minor break in the skin can introduce harmful bacteria into a wound. Always wear protective gloves if you have cuts or open wounds on your hands. When setting up material for cutting, always wear gloves that provide protection against sharp metal edges.



MANDATORY ACTION! Read the operator manuals

Refer to your OMAX JetMachining[®] Center Operator's Guide, P/N 400433, for additional safety requirements.



MANDATORY ACTION! Eye Protection

Always wear approved safety goggles whenever cutting. Regular glasses do not provide sufficient eye protection!



MANDATORY ACTION! Ear Protection

Always wear hearing protection while in the vicinity of the OMAX. When cutting in air, noise levels can exceed 120 dB.



WARNING! Flying Debris/Loud Noise

Eye and ear protection are always required during operation.

⚠ WARNING	
	WATCH YOUR HANDS AND FINGERS

WARNING!
Never place your hands or fingers in areas where they are in danger of becoming pinched or crushed during equipment operation.

⚠ WARNING	
	WATCH YOUR HANDS AND FINGERS

⚠ WARNING	
	KEEP GUARDS IN PLACE

WARNING!
 Never operate the OMAX with any of its protective guards or covers removed or rendered inoperative.
 Never make unauthorized alterations to the equipment or components.

⚠ WARNING	
	KEEP GUARDS IN PLACE

	⚠ WARNING
	Keep hands away from jet.

WARNING!
Never place your hands in the vicinity of the nozzle while cutting.

Seek immediate medical attention in the event of a waterjet injury. Injuries caused by high-pressure waterjets are serious. Do not delay!

	⚠ WARNING
	Keep hands away from jet.

	⚠ WARNING
	Worn slats can collapse under load causing injury. Do not step, stand, or walk on slats.

WARNING!
Never step, stand or walk on the support slats. They are weakened with continued cutting and may collapse under your weight.

	⚠ WARNING
	Pinch points. Keep hands clear!

WARNING!
Never place your hands or fingers in areas where they are in danger of becoming pinched during equipment operation.

⚠ WARNING
STAY CLEAR
 If you can read this sign, a cover is missing. Do NOT Operate with cover missing.

WARNING!

Never operate the equipment with the protective covers missing, exposing yourself to dangerous mechanical and electrical hazards. Never make unauthorized alterations to the equipment or components.

⚠ WARNING
STAY CLEAR!
 If you can read this sign, a cover is missing. Do NOT operate with cover missing.

⚠ WARNING



Do not disconnect abrasive hose with system pressurized.

WARNING!

Removing the abrasive feed hose from the nozzle while still under pressure will blow abrasive particles into the room air, getting into eyes and contaminating tools and machines.



Electrical Safety



WARNING! Electrical Hazard

Indicates the presence of life-threatening voltages. Never access areas labeled as such without first taking appropriate safety precautions: locking out power, verifying no voltage present on circuits prior to maintenance activities, etc.



MANDATORY ACTION! Lock out power

Never do maintenance on the OMAX equipment with the main AC disconnect ON, unlocked, or while the pump is in operation. Always follow standard lockout/tag-out procedures.

Attention! Prevent Equipment Damage

NOTICE
 Avoid machinery damage.
 Only use OMAX Grease
 part number 202335

Caution: If the grease used for lubrication is not compatible with OMAX Grease, a chemical reaction can occur that separates both grease types and impairs the lubrication qualities of both. Once this happens, a premature failure of a bearing or associate part is probable.

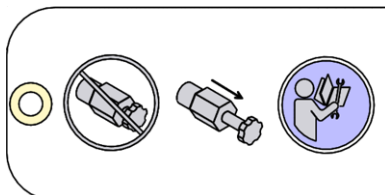

Caution: The Adjustable Dump Orifice was not designed to close completely as a “needle valve” would. NEVER screw the adjustment knob all the way in clockwise, forcing and jamming the stem into the tapered seat. Unjamming the stem requires that the ADO be disassembled. Read the OMAX ADO operator instructions!

Safety Precautions

Always observe the following safety precautions while operating your OMAX equipment. Carefully operated, the OMAX is a safe, productive tool. When operated carelessly, serious injury can easily result.

Table Safety Requirements

Do

- Be careful when handling materials in the tank. Fingers can be caught between heavy parts and the sharp edges of the support slats.
- Wear hearing protection while in the vicinity of the OMAX. When cutting in air, noise levels can exceed 120 dB.
- Cut under water whenever possible. When water covers both the material being cut and the nozzle tip, the noise level measured in the operator's area drops to approximately 80 dB.
- Wear approved safety goggles whenever cutting. Regular glasses are not sufficient eye protection!
- Have an eyewash station located near the OMAX in the event abrasive spray splashes into your eyes. The garnet abrasive is not a chemical irritant, but if not quickly washed out, it can injure an eye just as any sand would. In addition, tank water could contain chemicals irritants.
- Treat all injuries with caution. Because bacteria in the water can build up, even a seemingly minor break in the skin can introduce harmful bacteria into the wound. Any injury involving contact with the water should receive immediate attention. Use antibacterial chemicals in the tank water (exception is with EBBCO Closed Loop) to reduce this hazard, and always wear protective gloves if you have cuts or open wounds on your hands.
- Seek immediate medical attention in the event of a waterjet injury. Injuries caused by high-pressure waterjets are serious. Do not delay! Inform the physician of the cause of the injury, what type of waterjet project was being performed at the time of the accident, and the source of the water.
- When setting up material for cutting, wear gloves that provide protection against sharp metal edges and waterborne microorganisms.
- Dispose of cutting wastes properly and in accordance with all local and federal regulations. The OMAX produces two types of waste: the water used for cutting and the solid material that accumulates in the catcher tank. Although the garnet abrasive itself is inert, the waste deposited from the kerf material may require special handling.
- Because of inevitable water spills, cover the floor around the operator area with a nonslip material such as a textured rubber mat or nonslip paint.
- Use only approved work platforms. Never climb on or around the equipment using makeshift devices.
- Always use the muff on the abrasivejet nozzle. It helps keep the noise level low during machining and reduces splashing of water and abrasive.
- Always use proper lifting equipment to handle heavy work materials.
- Always remove power from the equipment when finished using the JetMachining Center for the day.

Don't

- Don't operate the OMAX JetMachining Center without first being adequately trained on how to operate it correctly and safely.
- Don't allow nozzle movement while handling material in the tank. Stop the abrasivejet before making any adjustments. Nozzle movement can exert up to 1,000 lbs (4.4 kN) of force, easily crushing any hands or fingers caught between it and another object.
Note: It's possible that the nozzle may move or become active during machine adjustments while power is still applied.
- Don't stand on the support slats. They are weakened by continued cutting and may not support your weight.
- Don't operate the OMAX with any of its protective guards or covers removed or rendered inoperative.
- Don't operate the OMAX in an explosive atmosphere. Machining titanium and certain other materials can produce sparks. Never allow explosive or flammable vapors to accumulate in the area of the OMAX.
- Don't allow unauthorized personnel access to the machining area without providing proper supervision.
- Don't switch tank chemicals for bacterial control without first reading the manufacturing warnings on the labels. Mixing different chemicals can create a hazardous situation.
- Don't use silica sand as a cutting abrasive. Fine silica dust produced by the cutting process can lead to silicosis, a serious lung disease.



- Don't operate the machine in close proximity to other machines or electrical equipment as water can spray or splash out of the cutting table area.

Pump Safety Requirements

Do

- Operate the OMAX pump only after reading this manual and receiving instruction from a qualified operator.
- Stay in a location within easy reach of the emergency stop switch.
- Start the pump only when all side panels are securely in place.
- Maintain all protective guards and shutdown devices around the OMAX pump.
- Immediately notify responsible repair personnel whenever leaks are detected in high-pressure fittings or connections.
- Follow the manufacturer's recommendations for servicing the equipment and use only original manufacturer replacement parts.
- Follow a periodic maintenance schedule that ensures proper equipment operation.
- At the conclusion of maintenance activities, clear all tools and rags from around the OMAX pump before operating the equipment.

Don't

- Don't start the OMAX pump unless you know how to stop it.
- Never open or do maintenance on the OMAX pump with the main disconnect ON or unlocked, or while the pump unit is operating. Always follow standard lockout/tag-out procedures.
- Don't apply power to this pump while maintenance work is in progress. Always lock the main power to the OMAX pump OFF at its source.
- Don't make unauthorized alterations to the equipment or components.
- Don't operate the abrasive waterjet for more than a few seconds when the standoff distance between the water level and nozzle tip is greater than 1.5". Above this height, the entrapped air can allow the jet stream to easily travel through the water and strike the tank bottom with sufficient force to cut through it.

Equipment Safety Features

The OMAX equipment provides several built-in safety features.

Emergency Stop Switch (E-Stop)

Both the pump unit and PC-based controller are equipped with an emergency stop switch. The E-Stop is engaged by pushing it in. Once engaged, it immediately shuts down the pump unit and abrasivejet. Refer to Figure 2-4 for an illustration of the E-Stop switch and its location on the controller front panel.

Overpressure Protection

During operation, pump pressure is monitored to prevent an overpressure condition. If the pump exceeds the factory set maximum pressure limit, the control shuts down the pump unit and displays the message "Dead Head of Pump". In addition to the software maximum pressure limit, all OMAX pumps are equipped with a factory set "Safety Valve" to provide a hard-plumbed, over-pressure limit.

Electrical Protection

The variable frequency drive (VFD) provides electrical protection as well as speed control for the pump's main drive motor. The DIN rail-mounted contactor and circuit breaker provide short circuit protection to the charging pump motor. Circuit breakers protect the internal transformer and a 0.5 Amp fuse protects the pump keypad.

Access Control Circuit

The OMAX Access Control Circuit (ACC) is designed to create a designated safety zone around an OMAX JetMachining Center that protects operators from injury when using the OMAX equipment. The access control circuitry continually monitors the closure status of two external switch contacts. The

breaking of contact with either switch immediately trips the safety circuit, disabling the cutting process until the cause of the violation is corrected and the access control circuit reset.

Note: *The ACC is an optional accessory but comes as standard equipment on OMAX machines sold in some countries.*

Lock-out/Tag-out Procedure

When powering down your equipment to perform required maintenance and service activities, OMAX recommends that standard lock-out/tag-out practices and procedures be implemented that isolate the equipment from its energy source(s) and prevent the release of potentially hazardous energy.

Note: *OMAX recommends the implementation of practices and procedures to shut down equipment, isolate it from its energy source(s), to prevent the release of potentially hazardous energy while maintenance and servicing activities are being performed.*

Disposing of Waste Materials

In abrasivejet cutting, garnet particles are accelerated with high-pressure water to strike the material creating a residue of abrasive grit and eroded particles from the work-piece. Eventually, this residual sludge settles to the catcher tank bottom and accumulates until it must be removed for disposal. Depending upon the material makeup of this sludge, different disposal constraints will be imposed by the various local and federal regulations. For example, when cutting toxic materials, such as lead or radioactive metals, appropriate measures for the safe disposal of this type of contaminated water and sludge must be rigidly followed. Always consult with your local utilities company about sewage or water treatment requirements and proper sludge disposal procedures.

Adequate Shop Ventilation

Machining certain types of material such as titanium with a waterjet will produce sparks. Do not operate a waterjet in an explosive atmosphere or allow explosive or flammable gasses to accumulate in the work area. Proper shop ventilation will assist in dissipating the accumulation of gas, vapor, and fumes. When cutting aluminum, the fine particles in the tank react with the water to generate hydrogen gas which bubbles to the surface and escapes into the shop in harmless, low concentrations; however, it can also accumulate in the air dome used for water level control. Air dome gases are purged when the water level is raised and lowered during normal operation, so that no large amount of gas can accumulate anyway. It is recommend that during the course of turning the machine ON or OFF (at a shift change or between jobs), the machine operator lower the water level completely to expel gasses which may have accumulated in the air dome. And, if you periodically check on equipment operation during lengthy continuous use (e.g., checking for smooth operation during a long job), use that opportunity to also completely lower the water level. Always ensure that an ignition source (e.g., open flame, electrostatic discharge) is not nearby when operating features on your OMAX or MAXIEM abrasivejet system.

OMAX JetMachining Center Safety Checklist

Safety Checklist Topics	
Safety Labels and what they mean	
	Wear Gloves
	Electrical Hazard
	Lock Out Power
	Eye Protection
	Ear Protection
	Flying Debris/Loud Noise
	Danger – Watch your Hands and Fingers
	Warning – Keep hands away from jet
	Warning – Worn slats
	Warning – Pinch points
	Danger – 480 Volts
Safety Precautions (Do)	
	Material handling
	Hearing protection
	Cutting under water
	Approved Safety goggles/ Eyewash Station
	Treat injuries with caution – wear protective gloves
	WJTA Warning Card – medical attention for any waterjet injury
	Special handling of hazardous materials
	Prevent slipping
	Use adequate ventilation
	Use only approved work platforms
	Use the splash guard (muff)
	Use proper lifting equipment
	Remove power from equipment when not in use
	Operate equipment after reading equipment manuals and receiving qualified instruction
	Be able to quickly access the emergency stop switch
	Start pump only when all side panels are in place
	Maintain protective guards and shutdown devices on/around pump
	Immediately notify repair personnel if leaks are found in pump fittings or connections
	Follow manufacturer's recommendations for servicing and use only original manufacturer replacement parts
	Follow periodic maintenance schedule that ensures proper equipment operation
	Following maintenance activities, clear all tools and rags from around the equipment before starting
Safety Precautions (Don't)	
	Don't start equipment unless you know how to stop it
	Never open or do maintenance on the equipment with the main disconnect ON or while the pump is operating. Always follow lockout/tag-out procedures
	Don't make unauthorized alterations to the equipment or components
Equipment Safety Features	
	Emergency (E-Stop) Switch (PC-based controller and pump)
	Overpressure Protection safety valve and software shutdown
	Electrical Protection
	VFD / DIN rail mounted contactor and circuit breaker (short circuit protection to the charge pump motor)/ Circuit breakers protect internal transformer/ 0.5 Amp fuse protects pump keypad

Date _____

Students Name _____ Signature¹ _____

¹ By signing this document, I acknowledge receipt and review of this OMAX Safety Checklist and understand items contained within. This document will be kept on file at OMAX in the Customer file.





The OMAX JetMachining Center

This chapter provides an overview of the JetMachining Center. It identifies each major component and describes its function.

The OMAX JetMachining Center

The OMAX JetMachining Center is a precision abrasivejet machining tool operating under software control and able to cut complex parts out of most materials including metal, plastic, glass, ceramics, stone and composites using standard CAD drawing files.

Nine different Models of the JetMachining Center are currently available from OMAX: the Models 2626, 2626|xp, 2652, 5555, 55100, 60120, 80160, 80X and 120X.

Description of JetMachining Center Components

OMAX JetMachining Centers can be divided into these major sections:

- **PC-based controller** (Figure 2-3, page 2-2)
- **X- Y and Z-axis motion system** (Figure 2-10, page 2-6)
- **Abrasivejet delivery system** (Figure 2-13, page 2-7)
- **Catcher tank** (Figure 2-20, page 2-11)
- **High-pressure pump** (see Chapter 3: Introduction to the OMAX Pump)

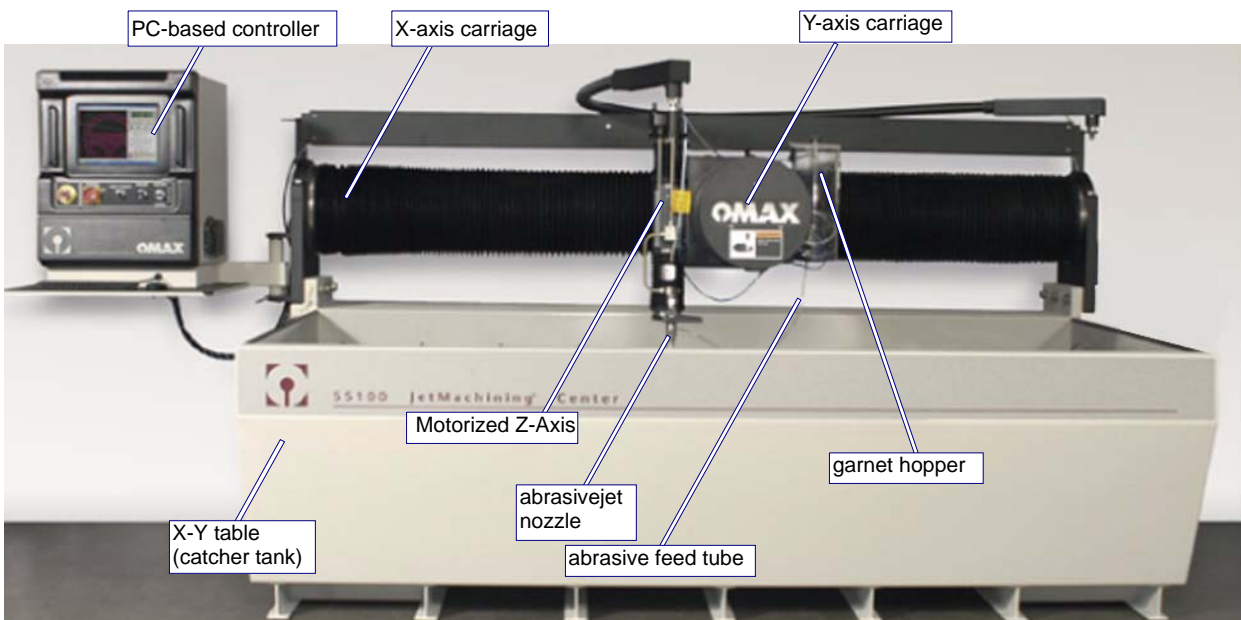

Figure 2-1: Components of the JetMachining Center Cantilever Style Models 2626, 2626|xp, 2652, 5555, and 55100 (illustrated)

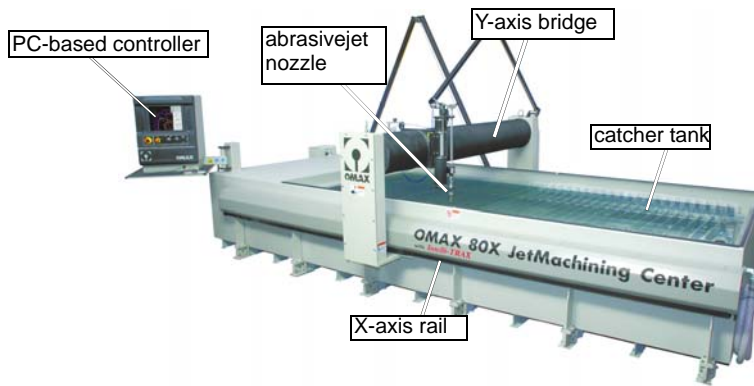

Figure 2-2: Components of the JetMachining Center Bridge Style Models 60120, 80160, 80X (illustrated), and 120X

PC-based Controller

The JetMachining Center PC-based controller (Figure 2-3) is identical for all OMAX models. It contains a standard video monitor with a Windows-based computer (PC) running the OMAX software that is responsible for starting and stopping the high-pressure water pump, turning the water and abrasive flow ON and OFF, and maneuvering the abrasivejet nozzle along its precise cutting path. This internal PC is easily accessed by lifting up the controller's bottom access panel. User access typically is required when inserting media into the CD/DVD drive or flash drive memory into one of the two USB ports (Figure 2-8). Directly below the monitor is the operator's control panel used in conjunction with the keyboard to run the JetMachining Center. The keyboard and mouse are designed specifically to withstand exposure to the water and abrasive particles presented in an abrasivejet environment. The controller's hinged arm allows it to be positioned in accordance with an operator's viewing requirements.

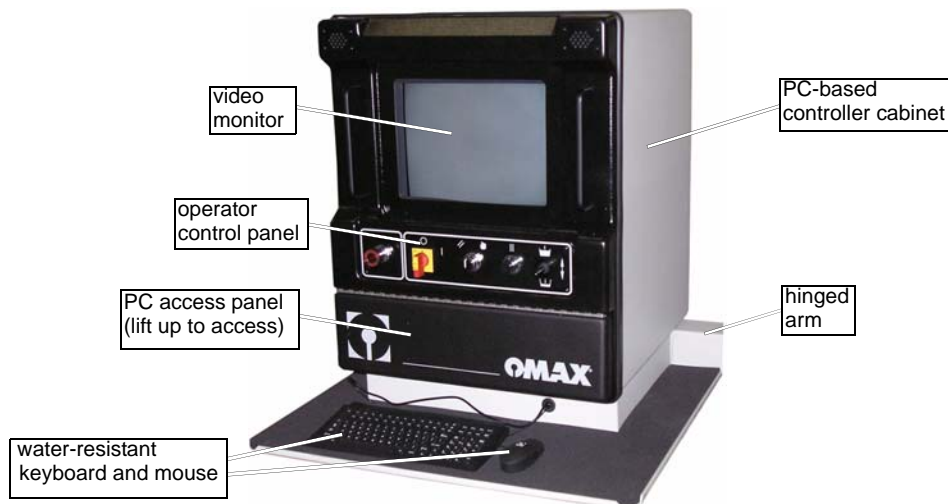

Figure 2-3: The JetMachining Center PC-based Controller

Front Panel

The JetMachining Center's Front panel provides five function switches for JetMachining Center operation (Figure 2-4):

- **Emergency stop (E-stop)**
- **Power ON/OFF**
- **Reset/override**
- **Pause**
- **Water level up/down**

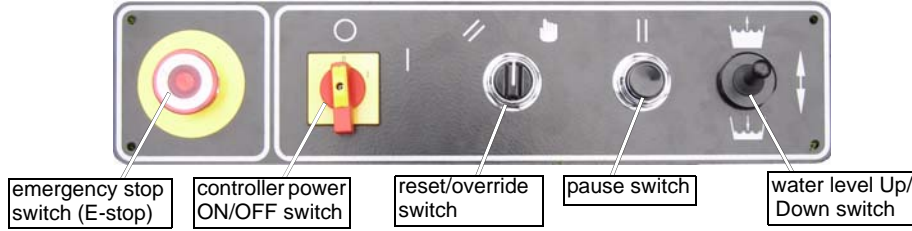

Figure 2-4: Control Panel Operator Switches

Control Panel Operator Switches



Emergency Stop

Immediately shuts down the high-pressure water pump and stops all abrasivejet operations. The emergency stop (E-stop) should be used only for real emergencies. When pressed, the OMAX not only stops cutting but also loses important machine positioning data.

Caution: *The abrasive feed line must always be cleaned out following an E-stop!*



Power ON/OFF

Turning the power switch to the ON (|) position on the front of the controller after the pump has been powered up, automatically starts the computer.



Reset

Disables all servo axis drives and resets any faulted drive.



Servo Motor Override

A manual override for diagnostic uses only and **not required** for normal operation.



Pause

Halts motion of the abrasivejet and shuts down operation of the abrasivejet nozzle. Machining can be restarted without loss of machine positioning information.



Water Level Up/Down Control

Raises (↑) and lowers (↓) the water in the catcher tank to cover/uncover the material being cut.

Internal PC-based Controller Components

WARNING! *The PC-based controller's electrical cabinet contains potentially lethal voltages. Prior to doing any service or maintenance activities inside this electrical enclosure, always turn OFF and lockout the OMAX AC power source and verify no circuit voltage is present.*

Access to the PC-based controller's internal components is via the locked handle on the rear of the enclosure. Components inside the controller are divided into two basic sections: the data control circuits and pneumatic control valves installed inside the rear panel door (Figure 2-5), and the PC and monitor units mounted inside the controller cabinet itself (Figure 2-6). At the bottom of the controller is a filter (Figure 2-7) allowing the air to be circulated and cool the internal components.

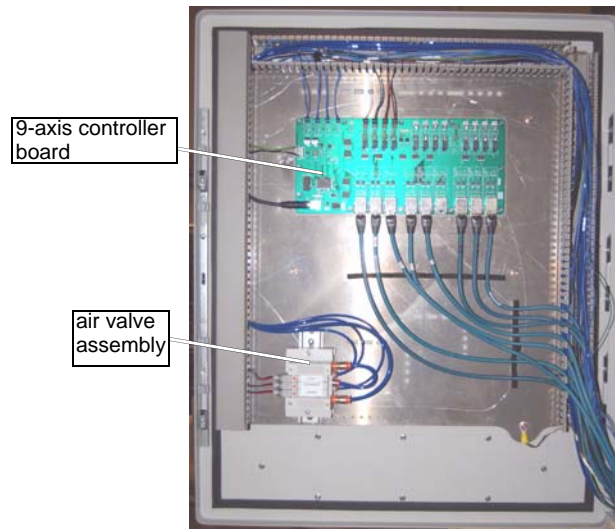

Figure 2-5: PC-based Controller 9-axis Back Panel

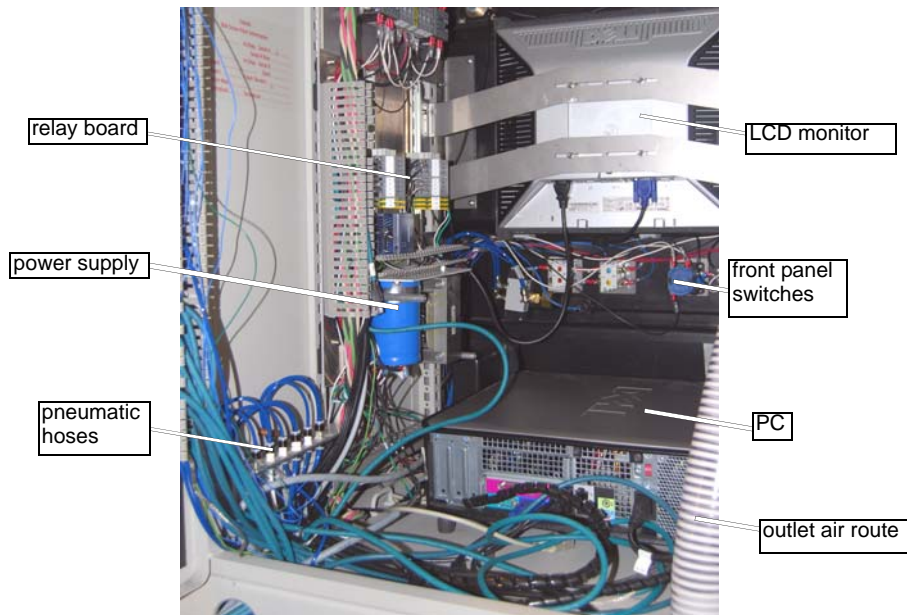

Figure 2-6: Internal Components of PC-based Controller Cabinet

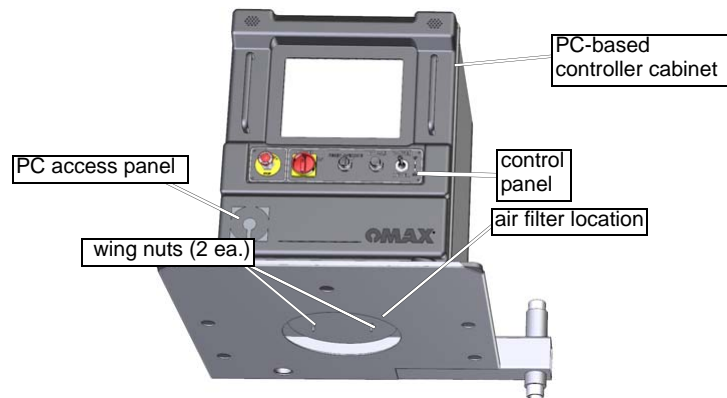

Figure 2-7: Air Filter Location Beneath the Controller Cabinet

Windows® PC

Inside the OMAX controller (Figure 2-6) is a standard PC with the Windows operating system running the OMAX **Make** and **Layout** software. To access the front of this PC, lift up the PC access panel (see Figure 2-3 for location).

The PC front panel presents the following devices to the OMAX operator (Figure 2-8):

- **CD/DVD drive**
- **CD/DVD drive open/close button**
- **USB ports (2 ea.)**
- **Power ON/OFF button**

Note: The PC automatically powers up when the controller ON/OFF switch (Figure 2-4) is ON. Use of the PC front panel Power ON/OFF switch is not required.

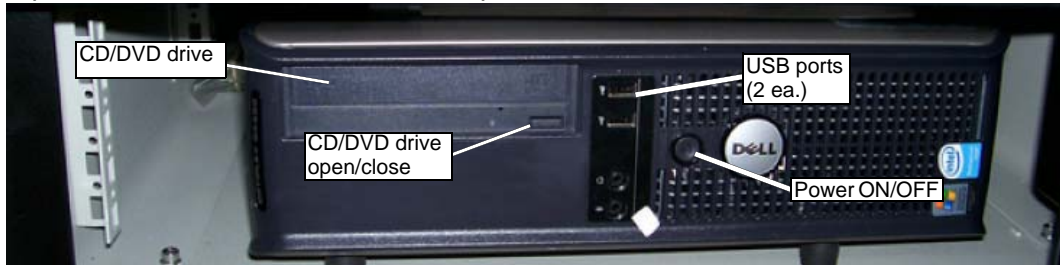

Figure 2-8: User Components on Front Panel of PC

PC Rear Panel

The back of the PC is accessible by opening the PC-based controller's rear door. During normal operation, there are few reasons for the user to access to the PC rear panel. Cabling to the PC rear panel is identified in Figure 2-9 below:

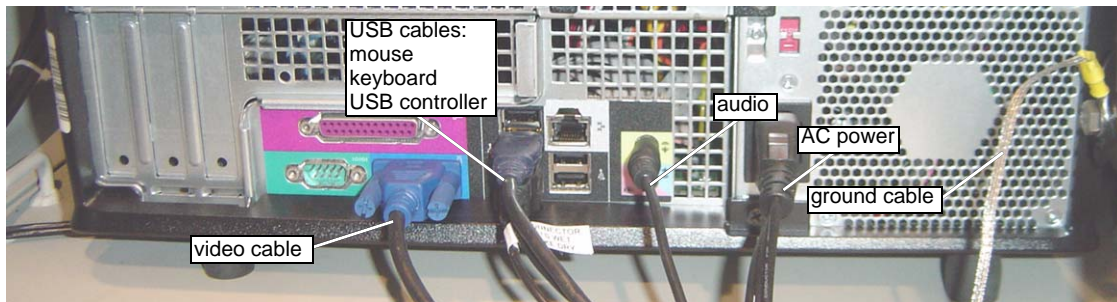

Figure 2-9: PC Rear Panel Cable Connections

X- Y- Z-axis Motion System

The precision X- Y-axis motion system installed on OMAX models 2626, 2626|xp, 2652, 5555, and 55100 consists of a bridge X-axis and a cantilever Y-axis rigidly mounted to the cutting table (see Figure 2-10). Both X and Y carriages ride on rigidly mounted linear rolling bearings. The carriages are moved by preloaded ball screws driven by steel reinforced timing belts from brushless digital servo motors that provide position feedback. Each step command to a servo amplifier moves the carriage approximately 0.0005" (0.013 mm).

The entire bearing and drive mechanisms are surrounded and sealed in urethane bellows that prevent water and abrasive particles from entering and severely damaging critical mechanical components.

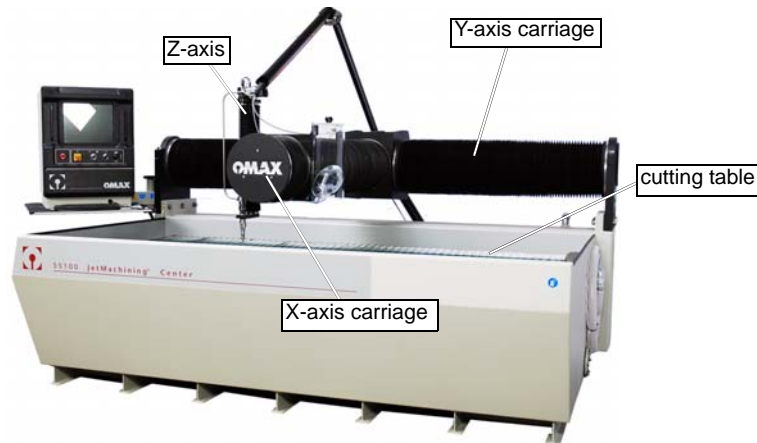

Figure 2-10: X-Y Carriage Components of the JetMachining Center Models 2626, 2626|xp, 2652, 5555, and 55100 (illustrated)

The 60120, 80160 and 80X motion systems consist of a Y-axis bridge attached to dual X-axis rails rigidly mounted to the catcher tank (see Figure 2-11).

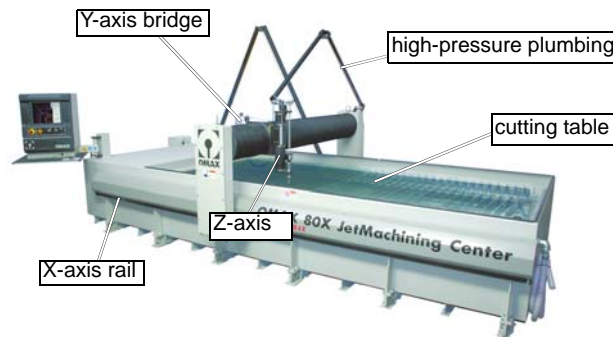

Figure 2-11: X-Y Components of the JetMachining Center Models 60120, 80160, 80X (illustrated), and 120X

The Y beam connects to the carriage that moves along the X-axis rail. X-axis movement for the 80160 is driven using the typical OMAX ball screw configuration. X-axis movement for the 60120, 80X, and 120X utilize a high-precision traction drive coupled with position feedback from magnetic encoding tape. In addition, their X-axis rails do not require lubrication and are resistant to garnet contamination.

The OMAX Z-axis motion system is responsible for nozzle movement in the up/down direction. The design of the Z-axis is practically identical for all OMAX tables. A manually operated Z-axis comes standard with a hand crank for position control. The optional Motorized Z-Axis is more common, using a synchronous motor under software control to drive a lead screw that allows height adjustments in 0.001" (0.0254 mm) increments (Figure 2-12). Both the manual and Motorized Z-Axis units are completely protected against water and grit contamination using urethane bellows.

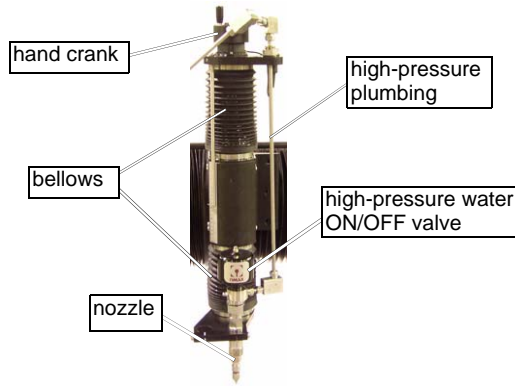

Figure 2-12: Motorized Z-Axis

Abrasivejet Delivery System

The abrasivejet delivery system consists of the high-pressure plumbing and swivels, a high-pressure nozzle, and an abrasive feed system (hopper).

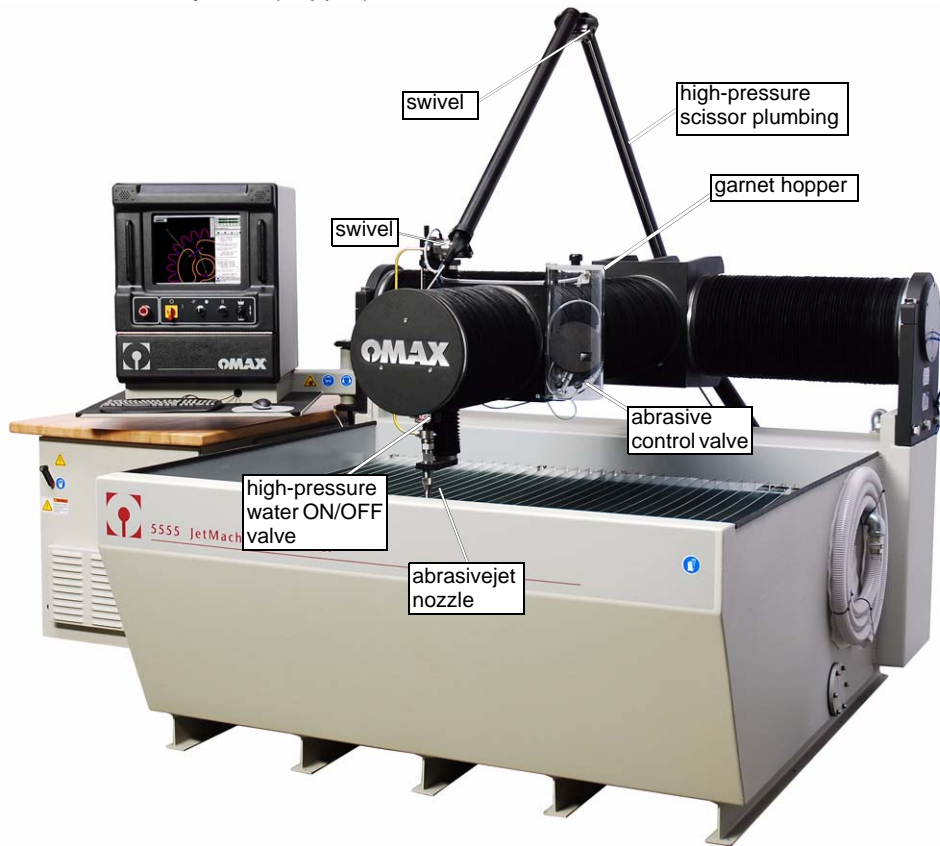

Figure 2-13: JetMachining Center Abrasivejet System Components (5555 illustrated)

Abrasivejet Nozzle

In an abrasivejet nozzle (Figure 2-14), when the high-pressure water is allowed to pass by the ON/OFF control valve, it is forced through a small hole in a jeweled orifice typically made of sapphire or diamond (Figure 2-15).

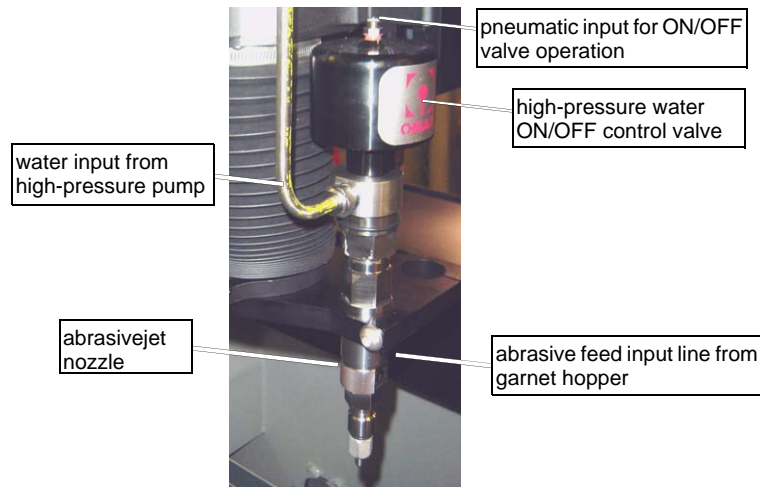

Figure 2-14: Components of an OMAX Abrasivejet Nozzle Assembly

This narrow stream of water exits the jeweled orifice travelling up to 2500 feet per second (760 m/s). As it moves into a larger chamber, the high-velocity stream of water draws in the abrasive from the abrasive feed tube. This stream of water with the acquired abrasive then moves into a mixing tube where the water and abrasive combine to form the abrasivejet stream which exits the mixing tube at the bottom of the nozzle to strike the material being machined.

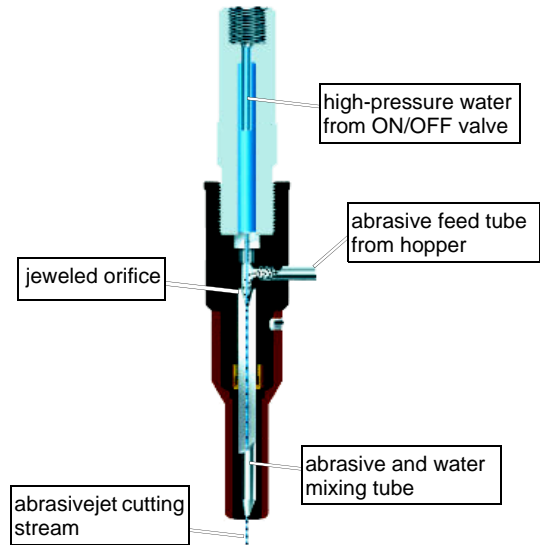

Figure 2-15: Internal Workings of the Abrasivejet Nozzle

The Abrasive Hopper

The abrasive hopper mounts to the OMAX Y-carriage and holds up to 25 pounds (11 kg) of abrasive. A hinged lid prevents dirt and other shop contaminants from mixing with the abrasive. The abrasive rate of flow is regulated by a computer-controlled pneumatic valve and orifice located at the bottom of the hopper.

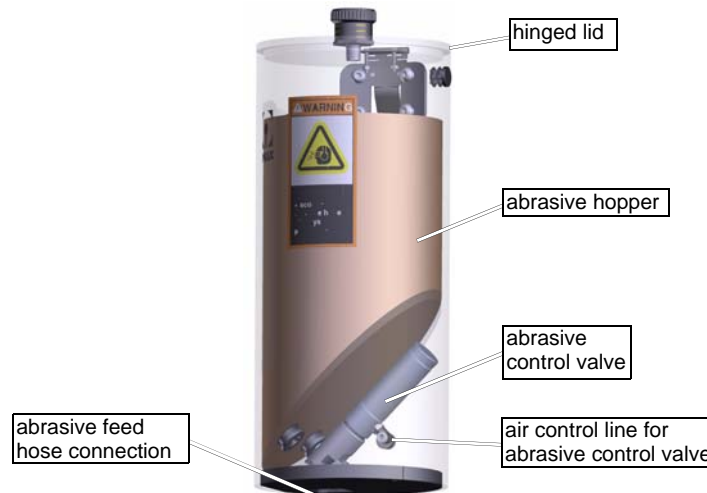

Figure 2-16: Abrasive Hopper Components

Caution: *The abrasive material in the hopper must be kept clean and dry. If moisture enters the hopper, the abrasive material will clump and clog the feed tube which will require cleaning. Even very small particles of dirt will clog the mixing tube. Always store your abrasive material in a covered, dry location protected from metal chips and other machining debris.*

When choosing abrasives, always pick a high-quality abrasive for your OMAX JetMachining Center. High-quality abrasives are much more consistent in abrasive particle size. Inconsistency in particle sizes makes it difficult to maintain quality and precision when cutting and also increases the likelihood of your mixing tube becoming plugged. High-quality abrasives also contain less dust. When dust is present, static electrical charges can build up, causing the abrasive particles to clump together, hindering good flow.

High-pressure Plumbing

The high-pressure plumbing routes the water from the OMAX pump to the abrasivejet nozzle. This system of plumbing includes the tubing, high-pressure fittings, swivels, and nozzle ON/OFF valve. Properly prepared and connected, ultra high-pressure (UHP) tubing and fittings are critical in maintaining a safe and leak-free, high-pressure system.

Swivels

Swivels are a key component in the OMAX high-pressure plumbing system. They allow the abrasivejet nozzle to move across the table surface when cutting and prevent water from leaking from the high-pressure plumbing system. Two different styles of swivels have been used on OMAX JetMachining Centers (see Figure 2-17): the **bulkhead swivel** and the **high-pressure swivel**. Bulkhead swivels were used on earlier OMAX table models; currently, they have been replaced by high-pressure swivels using the scissor-style plumbing and are no longer found on newer machines. The Model 2626 does not use swivels.

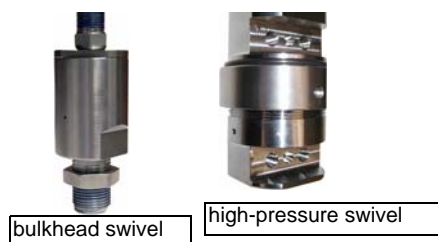

Figure 2-17: The OMAX Swivels

The Dual ON/OFF Valve

The Dual ON/OFF Valve controls water flow through the cutting nozzle (Figure 2-18) and operates in conjunction with the adjustable dump orifice (Figure 2-19) installed in the OMAX high-pressure pump.



Figure 2-18: Dual ON/OFF Valve with the OMAX MAXJET®5 Nozzle

When the nozzle is no longer cutting and the high-pressure water shuts OFF, the software automatically re-routes this water through the pump's dump valve orifice until the nozzle is again turned on to resume cutting. The dump valve then shuts off. This action allows a continual pump operation during times when the nozzle is not cutting and assures that the water pressure always remains the same, allowing the starting and stopping of the waterjet stream to take place without delay. This technique also enables dual pressure operations, as required for low-pressure glass piercing, for example, by opening both the dual ON/OFF valve and the dump valve simultaneously.

Matching the pressure of the nozzle to the pressure of the adjustable dump orifice is important in preventing damage to ultra high-pressure components. Ideally, at the end of a cut, water pressure gently falls to the traverse pressure, and, at the end of the traverse, the pressure rises to the cutting pressure without overshooting the mark.

The cutting head pressures observed when the machine is actually cutting should be 3-5 KSI above the adjustable dump orifice pressure. Dump orifice pressures are observed when the machine is traversing towards the next cut. For example, a cutting head pressure observed at 50 KSI should see traverse pressures of about 46 KSI.

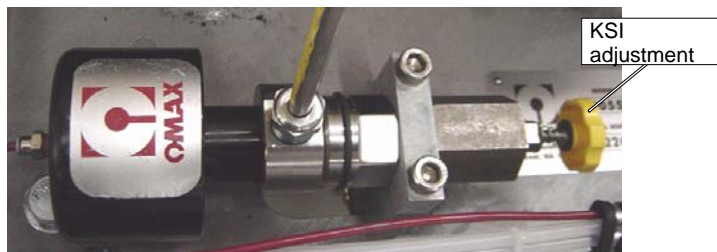

Figure 2-19: The Adjustable Dump Orifice used in OMAX Pumps

Catcher Tank

The JetMachining Center's large catcher tank stores the water from the cutting nozzle and provides a settling tank for the spent abrasive and cut away material (see Figure 2-20). Excess water exits the catcher tank by traveling through a water outlet filter screen (Figure 6-3) that can be raised or lowered to determine the tank's maximum water level.

A series of steel slats positioned above the catcher tank form the cutting surface that supports the part being machined. The Model 2626|xp high-precision JetMachining Center features a stainless steel tank, stainless steel slats, and stainless steel slats holders.



Figure 2-20: JetMachining Center Catcher Tank

Pressurized air is required to operate the valves that raise and lower the tank water level and turns On and OFF the nozzle water and abrasive flow. Tank water level is controlled using OMAX's Rapid Water Level Control (Figure 2-21).



Figure 2-21: OMAX's Rapid Water Level Control

The Rapid Water Level Control requires an auxiliary air source with the following specifications:

Pressure: 75 - 120 psi (517 - 827 kPa)

Flow Rate: 16.0 cfm (453 l/m) minimum

Internal air connections to the Rapid Water Level Control are identified in Figure 2-22:

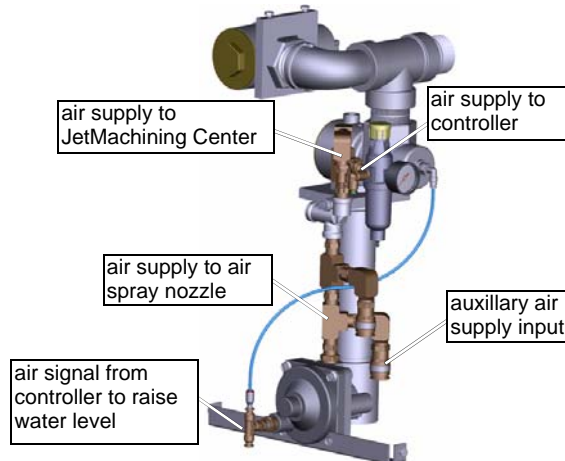

Figure 2-22: Rapid Water Level Control Internal Pneumatic Connections



Introduction to the OMAX Pump

This section introduces the OMAX high-pressure water pump unit and provides the following information:

- Describes the OMAX pump unit
- Identifies the pump components
- Provides an overview of the water circuit
- Explains how the OMAX pump works
- Provides an overview of electrical circuit
- Lists specifications for all OMAX pump models



Figure 3-1: OMAX High-pressure Water Pump

Description of the OMAX Pump

The OMAX variable speed, high-pressure pump is an electrically driven, variable speed, positive displacement, crankshaft drive triplex pump that provides the high-pressure water required by the OMAX JetMachining[®] System to operate.

The pump's major drive components include the variable frequency drive (VFD), the main electric motor, the belt drive between the motor and the high-pressure pump, and the crankshaft drive for the high-pressure pump. The electronic VFD varies the electric motor speed, and therefore the pump speed, by varying the frequency of the motor's electric power. The variable frequency drive accommodates slight variations in nozzle flow characteristics, produces no current surge upon starting, and provides high power factors and VFD/motor efficiencies throughout the useful power range.

All electrical control components and VFD are located in the electrical enclosure mounted on the right-hand end of the pump unit.

The main electric drive motor, belt drive, and OMAX high-pressure crankshaft drive pump assembly are mounted on a welded steel tray connected to a steel pump frame with anti-vibration mounts. The water module is mounted on a steel tray and consists of the water tank and charge pump.

Removable covers are provided on the front, back, and left-end of the pump unit. The pump's laminated wood top can be raised, allowing easy access to the water filters and pump's high-pressure wet end.

The charging pump brings water from the water tank to the filters. Cooling water is recycled back to the water tank.

Pump Components

Pump Viewed from Front and Right Side



Figure 3-2: OMAX Variable Speed High-pressure Pump Front View

Front Pump View with Front Panel Removed

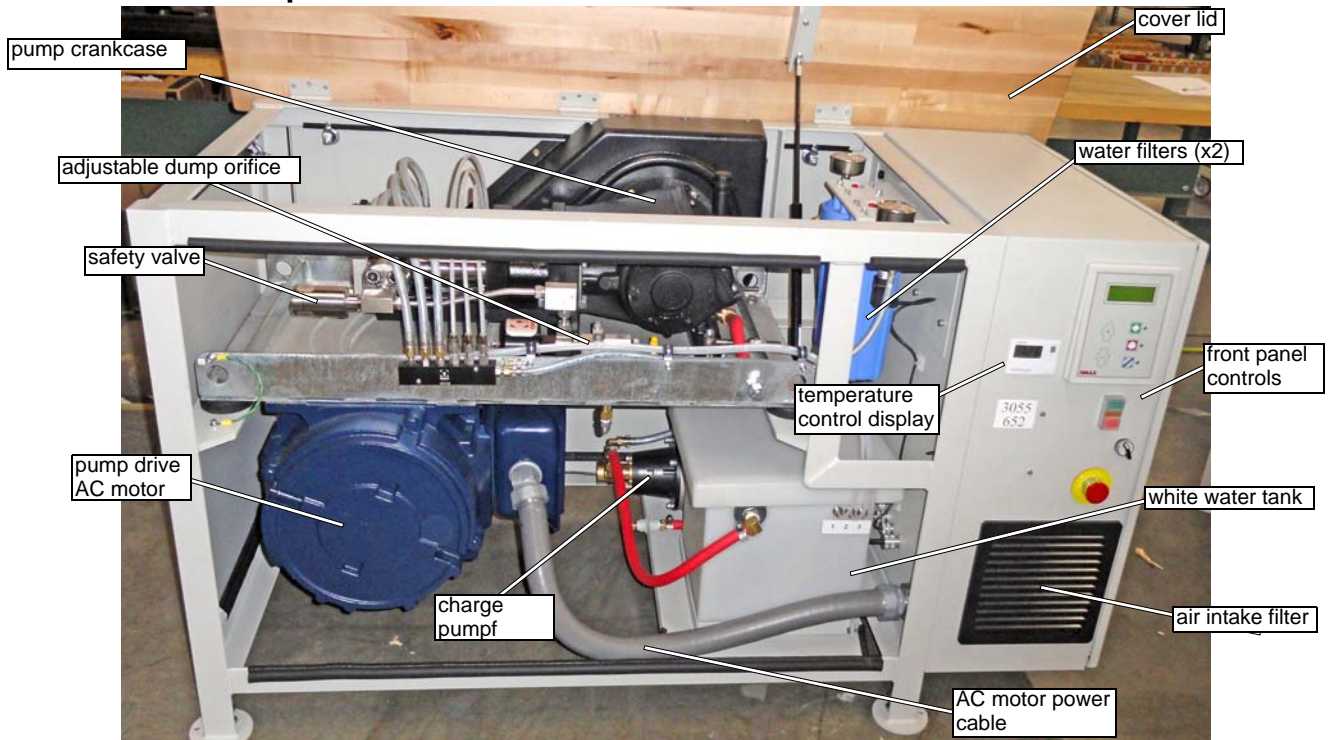

Figure 3-3: Pump with Top Lid Open and Front Panel Removed

Rear Pump View with Rear Panel Removed

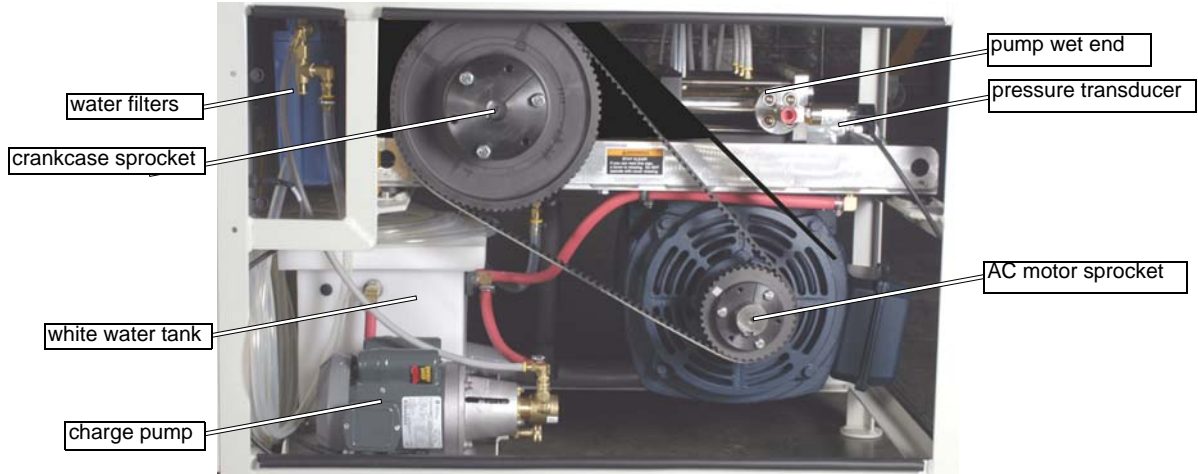

Figure 3-4: Pump with Rear Panel Removed

Top Pump View with Lid Opened

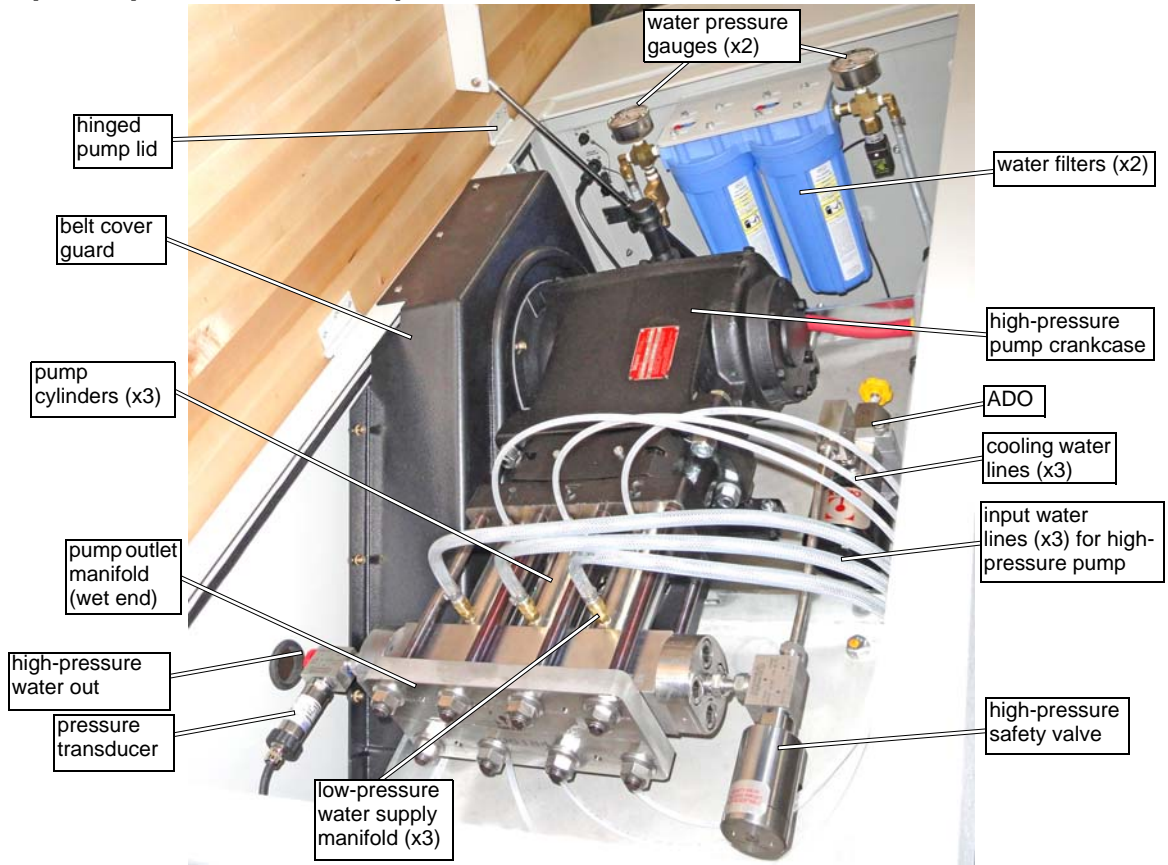

Figure 3-5: Top View of Pump with Lid Open

Pump Side View with Right Panel Open

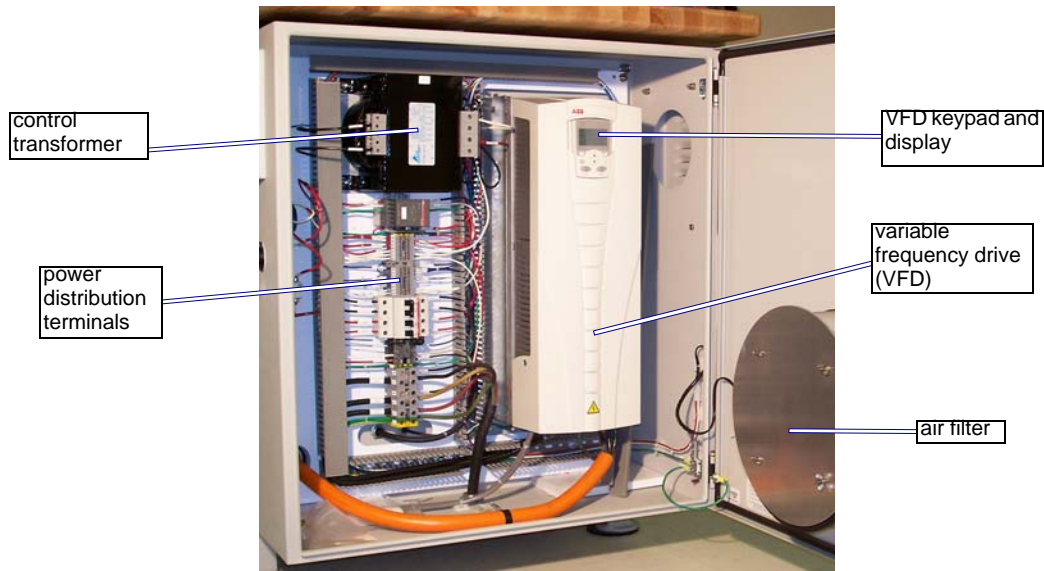

Figure 3-6: Pump Internal Components on the Right Side

Pump Control Panel

The pump's operator controls are located on the front panel at the right-hand end of the pump. See Figure 3-2, page 3-2, for illustration. The panel has a 5-button keypad with display, pump ON/OFF Switch, Manual Charge Pump Switch, and an Emergency Stop Switch (E-Stop).

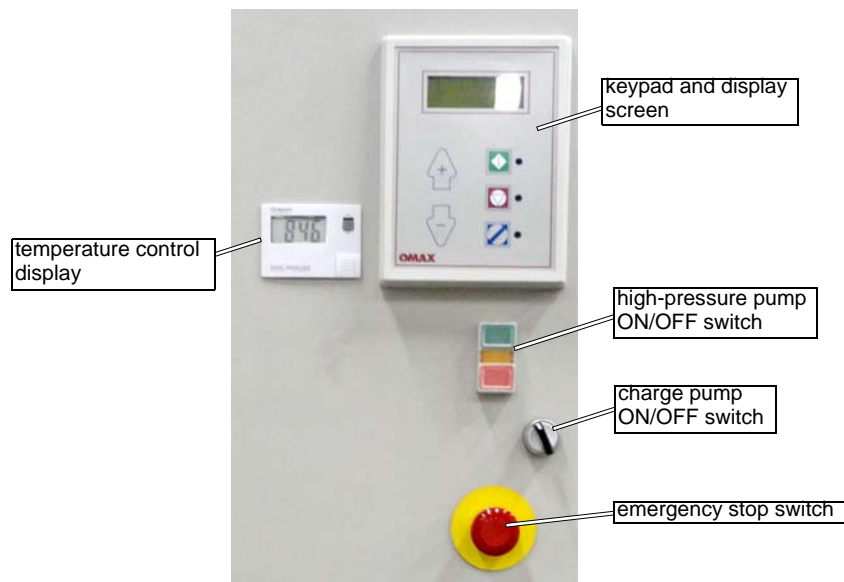

Figure 3-7: Pump Control Panel

The pump control panel has two modes of operation: **Keypad** and **Remote**. If the pump unit operates as a standalone pump, control is via the keypad only. If the pump unit operates with an OMAX JetMachining Center, control is shared between the JetMachining Center Controller and the pump's keypad.

High-pressure Pump ON/OFF Switch

The pump ON/OFF switch controls power to the keypad and display. When switched OFF, the keypad is disabled, the display goes blank, and the pump immediately stops. When switched ON, the keypad and display both become enabled; the pump is also enabled but starts only when either the **Run** button is

pressed if the pump is in a standalone mode, or a remote command is received from the OMAX JetMachining Center.

WARNING! *The pump ON/OFF switch will not remain in the ON position unless power to the pump unit is received from the AC main power disconnect. Whenever power at the main disconnect is ON, there is always live AC power on the DIN rail and at the terminals inside the pump electrical enclosure even when the pump ON/OFF switch is OFF.*

Charge Pump ON/OFF Switch

The charge pump is responsible for the pre-circulation of water through the pump reservoir tank and cooling lines. This flow purges warm water from the reservoir tank and the pump cooling lines before the high-pressure pump starts. Cooler water increases the life of the high-pressure pump seals.

The charge pump ON/OFF switch on the pump's front panel, controls power only to the charge pump; however, the charge pump must be ON for the high-pressure pump to start. If an attempt is made to start the high-pressure pump from the PC-based controller without the charge pump running, the high-pressure pump will not start and an error message appears on the pump's front panel display.

Emergency Stop Switch (E-stop)

Pushing the E-Stop switch in immediately shuts down both the pump and display. The E-Stop is disengaged (reset) by manually pulling it back to its original position. The pump cannot be restarted until the E-Stop is reset.

Note: *If the pump is connected to an OMAX JetMachining Center, pushing E-Stop in at any time (either the E-Stop on the pump itself, or the E-Stop on the JetMachining Center) immediately shuts down both the pump and the JetMachining Center. If the computer and controls are being powered from an alternative 115 VAC source, the pump E-Stop stops only the pump and not the controller.*

Operator Keypad and Display Screen

The keypad provides five function buttons and a four-line message display screen. See Figure 3-8, below, for illustration.

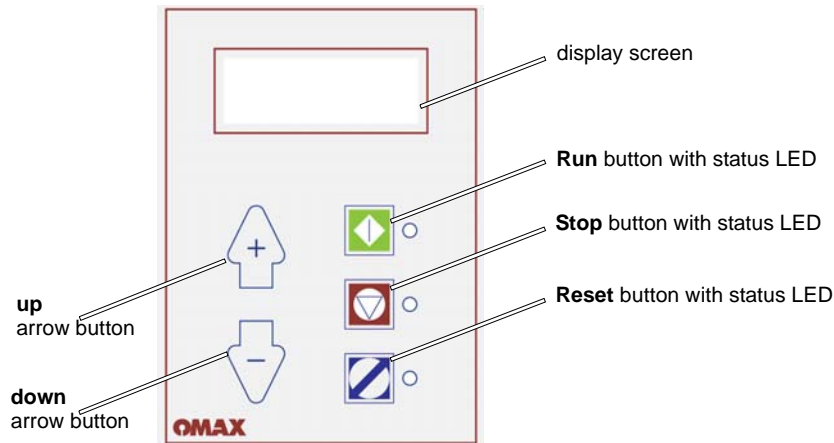

Figure 3-8: Front Panel Keypad and Display Screen

Display Screen

When the pump is operating normally, these four lines of text appear:

Water Pres	xx.x KSI	-	pump output pressure in KSI
High PreSet	xxxx RPM	-	preset drive motor high RPM
Low PreSet	xxxx RPM	-	preset drive motor low RPM
RunTime	xxx HRS	-	accumulative number of pump run hours

Water Press T

Pump output pressure in kpsi - the "T" appears when the value displayed is from the pressure transducer

Note: A "T" appears with the water pressure information ("Water Pres T") if a pressure transducer is connected and recognized by the pump controller card.

Hi Pre Set

Preset drive motor high RPM

Low Pre Set

Preset drive motor low RPM when low-pressure mode is invoked by the OMAX JetMachining Center Controller.

RunTime

Hour Meter, accumulative number of hours the drive motor/pump has run. It is not resettable.

The five buttons on the OMAX Keypad function as follows

**Run Button**

Starts the pump when pressed if operating in a standalone mode (not being controlled by the OMAX JetMachining Center). When started, the motor RPM (pump pressure) will return to the last value of **Hi Pre-Set**. The red status LED to the right of this button is lit when the pump is in the "run" mode.

**Stop Button**

Immediately stops pump operation whenever pressed if in standalone keypad or remote mode. When held down for 3 seconds, displays the pump's operational mode, the rated pressure, and software version. The red status LED to the right of this button is lit while the pump is stopped.

**Reset Button**

Clears a pump fault condition. Pressing either the **up** or **down arrow** while also pressing the **Reset** button, sets the **Low Pre-Set** pump motor RPM (low pressure). The red status LED to the right of this button is lit whenever the pump is in a fault condition. A reset is required for recovery.

**Up/down Arrow Buttons**

Pressing the **up arrow** increases the pump's RPM which increases water pressure. Neither pressure nor RPM can be increased above their maximum allowable limits. Pressing the **down arrow** at any time decreases pump RPM and pressure down to the minimum RPM.



Fault Messages

If a fault occurs, the pump shuts down, and a fault message indicating the type of fault is displayed on the first three lines of the OMAX keypad screen. Refer to Keypad Display Messages, page 8-1, for complete details.

Pump Operating Characteristics

- The pump's electric motor should always be operated at or above the minimum RPM to ensure sufficient lubrication of the pump crank within the crankcase. The pump control will not permit sustained operation below the minimum RPM.
- The maximum design output pressure is limited to 50,000, or 55,000 psi, depending on the specific pump model. The pump control does not allow sustained operation above these limits.
- **Low PreSet** is the factory set value of motor RPM for low-pressure operation and can be changed at anytime by the user. When operating with the OMAX JetMachining Center, this is the operating pressure for piercing and etching and is activated from the JetMachining controller.
- **Hi PreSet** is the factory set motor RPM value for high-pressure operation and also can be changed at anytime by the user until the maximum allowed output pressure of the pump is reached. The Hi PreSet value can be adjusted up to, but not above, the Operating Point output pressure value, or a maximum of 2000 RPM. Hi PreSet is the motor RPM value that the pump normally returns to when started. When operated with the JetMachining Center, it is the high-pressure mode.

- **Operating Point** is the motor RPM corresponding to maximum performance and maximum horsepower available.

How the OMAX High-pressure Pump Works

The OMAX pump works as follows (refer to Figure 3-9 below):

1. The **PLUNGER** is drawn back (to the right in the figure) by motion of the crank.
2. This draws water in through the **WATER INLET PORT**, past the **INLET CHECK VALVE BALL**, and into the **CYLINDER**. During this suction stroke the **OUTLET CHECK VALVE BALL** prevents high-pressure water entering the **CYLINDER** from the **OUTLET PASSAGE**.

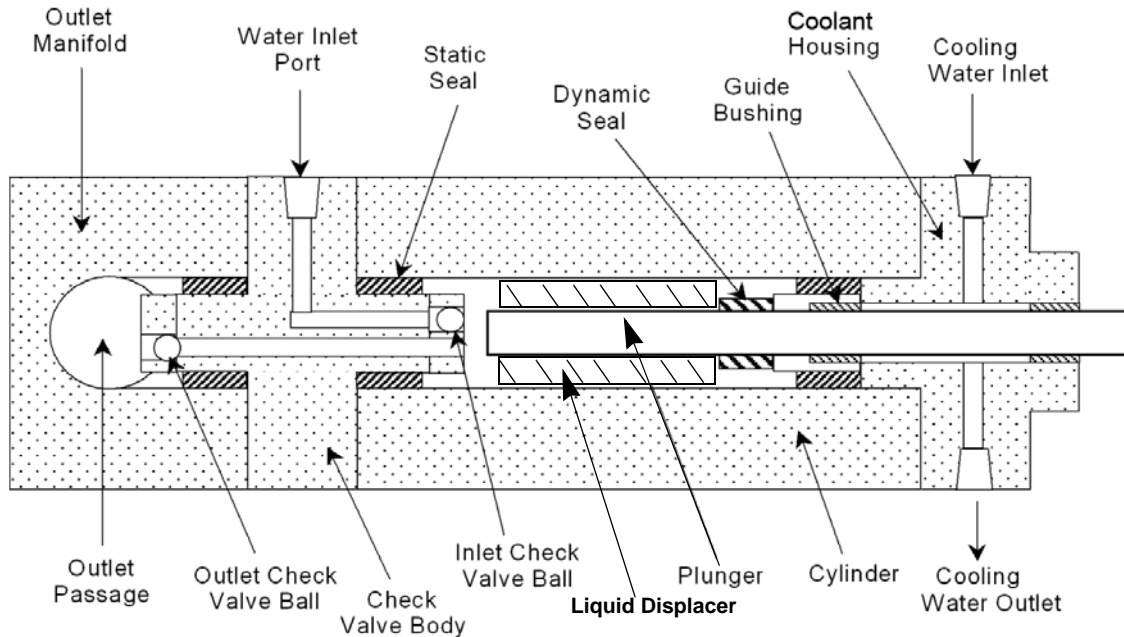

Figure 3-9: Details of the Pump wet end

3. At the bottom of the **PLUNGER** stroke, the **CYLINDER** fills with water.
4. As the **PLUNGER** moves back, pressure inside the **CYLINDER** increases as the water is compressed. The **INLET CHECK VALVE BALL** prevents the compressed water from flowing back out the **WATER INLET PORT**. The **LIQUID DISPLACER** occupies dead space within the cylinder and improves volumetric efficiency.
5. When pressure in the **CYLINDER** reaches the same pressure as in the **OUTLET PASSAGE**, the **OUTLET CHECK VALVE BALL** moves away from its seat, allowing the water to pass into the **OUTLET PASSAGE**.
6. When the **PLUNGER** slows and stops at its original top-dead center position (step 1), the pressure inside the **CYLINDER** falls, and the **OUTLET PASSAGE** closes OFF. This cycle then repeats.
7. High-pressure **STATIC SEALS** prevent water from leaking between the **CYLINDER** and the **CHECK VALVE BODY**, between the **CYLINDER** and the **BUSHING HOUSING**, and between the **CHECK VALVE BODY** and the **OUTLET MANIFOLD**.
8. A high-pressure **DYNAMIC SEAL** prevents water from escaping around the **PLUNGER**.
9. To prolong the life of the **DYNAMIC SEAL**, **GUIDE BUSHINGS** are used to maintain alignment of the **PLUNGER** through the **DYNAMIC SEAL**.
10. The **BUSHING HOUSING** has a **COOLING WATER INLET** port and **COOLING WATER OUTLET** port which allow water to flow through the **BUSHING HOUSING** to cool the **PLUNGER** and lubricate the **GUIDE BUSHINGS**. The cooling water also picks up any leakage from the **DYNAMIC SEAL** and recycles it back to the water tank.

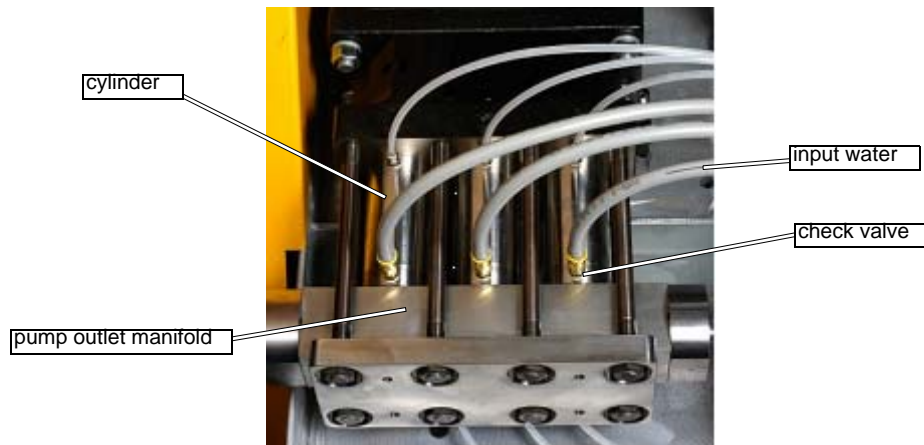

Figure 3-10: The High-pressure wet end for the OMAX Pump.

How the OMAX Charge Pump Works

The OMAX pump unit contains a manually switched charge pump and filter system that must provide at least 50 psi of inlet water pressure to the crankshaft drive high-pressure pump. Water pressure readings at the water filter gauges (see Figure 5-52) typically range from 90-120 psi.

The charge pump allows the OMAX pump unit to be connected to low-pressure water sources that may vary over a wide range of available pressures. Part of the water supplied to the OMAX pump unit functions as cooling water for the high-pressure seals and plungers. When a chiller is installed to cool the water source, this cooling water is recycled back through the white water tank for reuse rather than going to the waste water drain.

Manual control of the charge pump allows it to be run independently at any time to purge the tank and water lines with cooler water prior to starting the main high-pressure pump. This increases the life of the high-pressure seals.

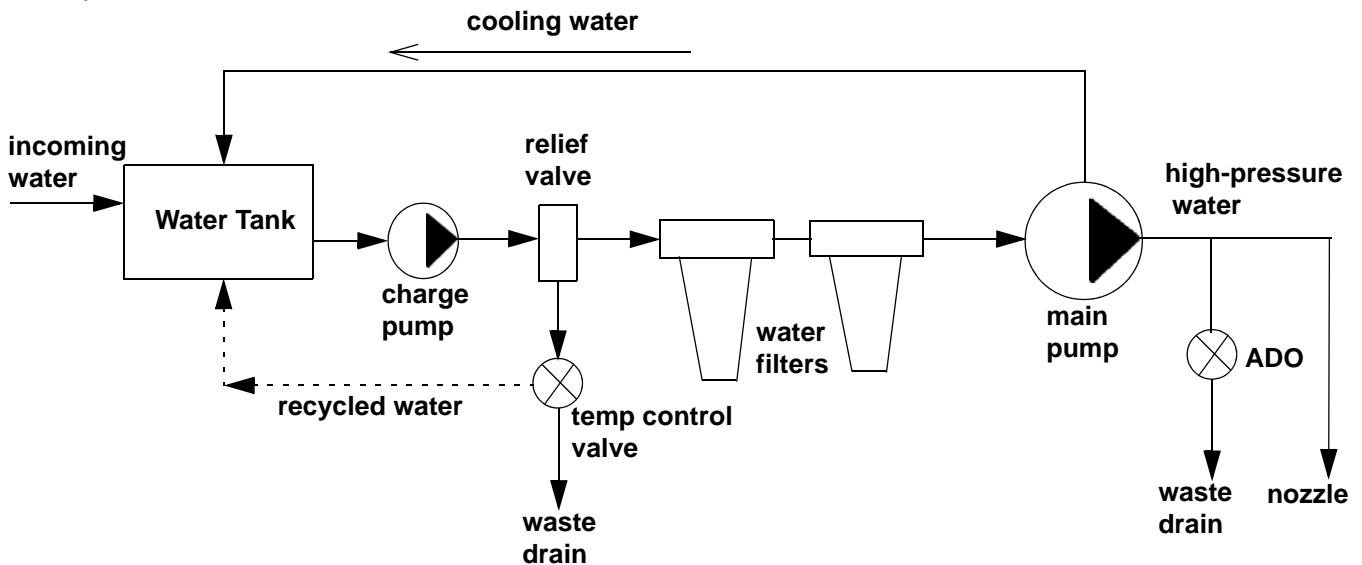

Figure 3-11: The Charge Pump Low-pressure Water Circuit

How the Pump's Electrical Circuits Work

The simplified diagram shown below provides an overview of the electrical components and electrical logic of the OMAX pump.

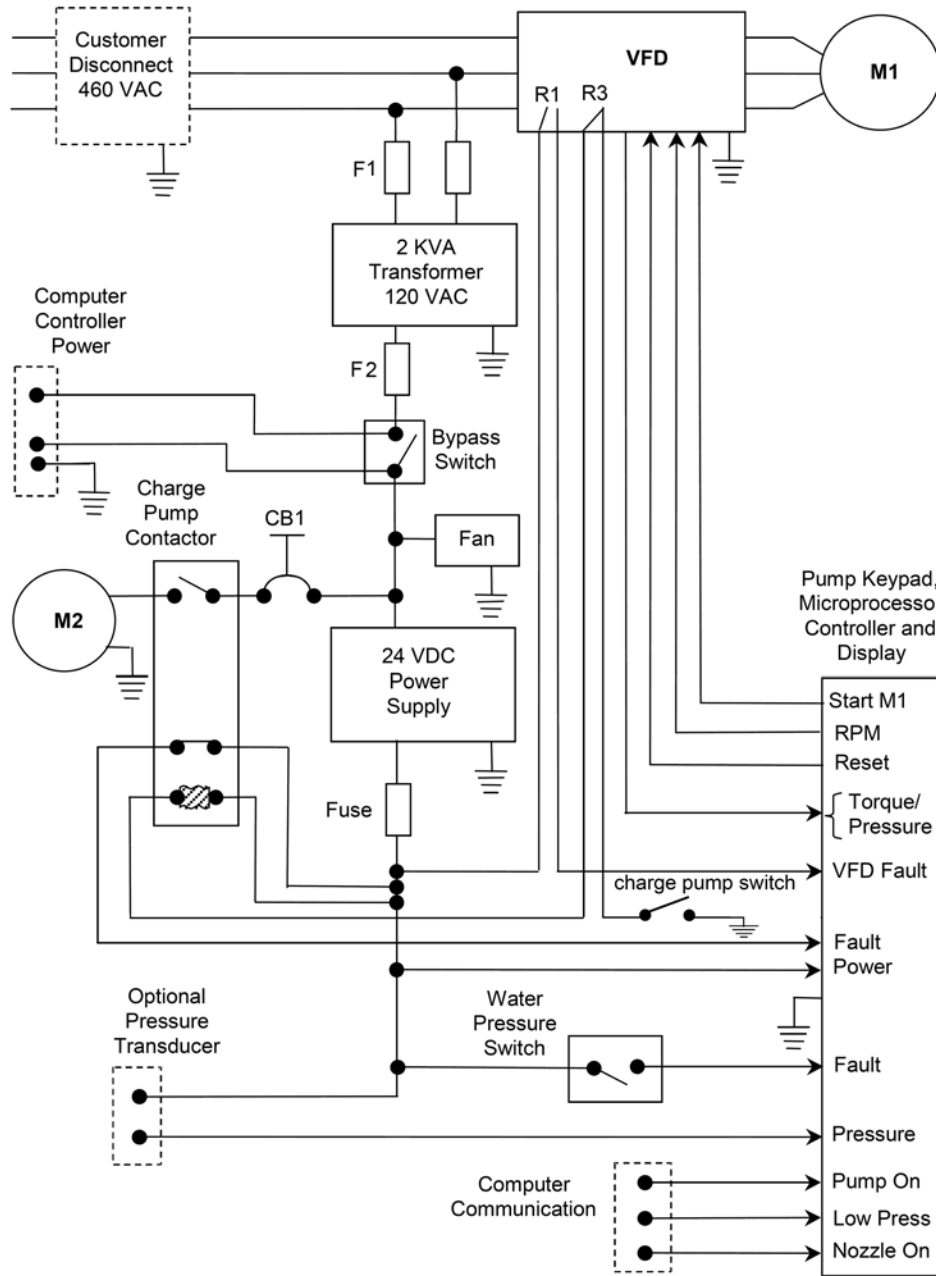

Figure 3-12: Simplified Pump Electrical Diagram

Note: When troubleshooting electrical or control problems with your OMAX pump, the detailed electrical schematics that are provided in addition to this document should be consulted.

- The main 460 VAC three-phase power (380 or 415 VAC for international applications) comes into the OMAX electrical enclosure from the CUSTOMER DISCONNECT and supplies power directly to the VFD.
- The VFD in turn, when given the command from the OMAX pump MICROPROCESSOR CONTROLLER, starts and runs the main pump motor, M1.
- The VFD is protected from line voltage surges by internal transient voltage surge suppression.

- Two legs of the 3-phase power the 2 KVA TRANSFORMER that steps the voltage down to 120 VAC.
- The 2 KVA TRANSFORMER (and everything downstream of it) is protected by the two-pole circuit breaker, CB1. Turning OFF CB1 kills the power to the 2 KVA TRANSFORMER and all the 120 VAC and 24 VDC power in the OMAX pump. The only component within the pump powered is the VFD. Immediately downstream of the 2 KVA TRANSFORMER is the fuse, F2. Removing F2 kills all 120 VAC and 24 VDC power in the OMAX pump with the exception of the VFD and the 2 KVA TRANSFORMER.
- The electrical enclosure cooling FAN, the Jet Machining Center COMPUTER CONTROLLER, the charge pump motor, M2, and the 24 VDC POWER SUPPLY are powered with 120 VAC from the 2 KVA TRANSFORMER.
- Connecting the COMPUTER CONTROLLER for the OMAX Jet Machining Center externally, completes the 120 VAC circuit within the OMAX pump to power the FAN, the charge pump motor, M2, and the 24 VDC POWER SUPPLY.
- Without the COMPUTER CONTROLLER connected, the BYPASS SWITCH must be closed to complete the 120 VAC circuit and power the FAN, the charge pump motor, M2, and the 24 VDC POWER SUPPLY.
- Through the COMPUTER CONTROLLER power circuit, the emergency stop switches (not shown in the simplified diagram) on the COMPUTER CONTROLLER, and the OMAX pump are in series. Pressing either emergency stop shuts down both the OMAX pump and the COMPUTER CONTROLLER.
- Manually closing the Charge Pump ON/OFF Switch starts the charge pump at any time.
- Charge pump motor, M2, is protected by the circuit breaker, CB1. Turning OFF CB1 prevents the charge pump motor, M2, from starting even though the CHARGE PUMP SWITCH may be ON and the CHARGE PUMP CONTACTOR closed.
- The entire 24 VDC portion of the electrical circuit is protected with the 0.5 amp FUSE immediately after the 24 VDC POWER SUPPLY.
- The pump MICROPROCESSOR CONTROLLER and control circuit operate with 24 VDC power provided by the 24 VDC POWER SUPPLY.
- The WATER PRESSURE SWITCH protects the OMAX pump from running without a water supply, or without sufficient charge pressure. It closes at charge pressures below 50 psi and provides a 24 VDC signal to the pump's MICROPROCESSOR CONTROLLER.
- If a PRESSURE TRANSDUCER is installed on the OMAX pump, it is powered by the 24 VDC POWER SUPPLY and the pressure signal is sent directly to the pump MICROPROCESSOR CONTROLLER.
- If an OMAX Jet Machining Center COMPUTER CONTROLLER is connected through the COMPUTER COMMUNICATION, control of the OMAX pump is via the Jet Machining Center COMPUTER CONTROLLER. It controls PUMP ON and OFF. It also commands the OMAX pump LOW-PRESSURE mode, which can be commanded only from the OMAX Jet Machining Center COMPUTER CONTROLLER.
- The OMAX pump MICROPROCESSOR CONTROLLER handles operation of the pump. It consists of a microprocessor, display, and keypad. It is powered by the 24 VDC POWER SUPPLY.
- The OMAX pump MICROPROCESSOR CONTROLLER provides three commands to the VFD:
 - Start M1
 - Set the RPM for the main motor, M1
 - Clear a VFD fault
- The pump MICROPROCESSOR receives two signals from the VFD: the main motor M1 torque (which is representative of pump pressure) and the VFD FAULT signal.
- If for some reason the VFD faults, the VFD shuts OFF the main motor M1, opens relay R2 which shuts OFF the charge pump, and closes relay R1 which sends a VFD FAULT signal to the pump MICROPROCESSOR CONTROLLER. The MICROPROCESSOR CONTROLLER then reports on the pump DISPLAY that a VFD FAULT has occurred. To clear the fault, the MICROPROCESSOR CONTROLLER can be commanded to clear the fault condition of the VFD by pressing the RESET button on the keypad. The pump can then be restarted.
- In addition, the pump MICROPROCESSOR CONTROLLER detects and reports a FAULT status of the CHARGE PUMP CONTACTOR if it should be closed but remains open. It also detects and reports a FAULT status if the charge pressure is less than 50 psi when the charge motor M2 is running.
- When connected to the OMAX Jet Machining Center COMPUTER CONTROLLER, the pump MICROPROCESSOR CONTROLLER receives and interprets the PUMP ON or OFF, LOW PRESSURE, and NOZZLE ON or OFF signals from the COMPUTER CONTROLLER.

Pump Specifications

	P3055V	P4055V
Dimensions		
Height	38.5 in (97.8 cm)	38.5 in (97.8 cm)
Width	66 in (167.6 cm)	66 in (167.6 cm)
Depth	36 in (91.5 cm)	36 in (91.5 cm)
Weight	1700 lb. (773 kg)	1750 lb. (750 kg)
Pump Unit		
Type	Fixed displacement, triplex	Fixed displacement, triplex
Inlet water	0.5 gpm (1.8 lpm) at 3 to 150 psi (20-100 Kpa)	1.3 gpm (4.9 lpm) at 3 to 150 psi (20-100 Kpa)
Charge water tank	5 gal. with float valve	5 gal., with float valve
Filtration provided	0.2 micron	0.2 micron
Output Pressure	55 KSI (380 MPa)	55 KSI (380 MPa)
Electric Motor		
Type	Marathon 30 hp (22 kW)	Marathon 40 hp (30 kW)
RPM	600 to 2000	600 to 2000
Voltage	380, 415, or 460 VAC 3-phase *	Voltage 460 (380 or 415 International) VAC 3-phase *
Frequency	50/60 Hz	50/60 Hz
Variable Speed Drive		
Type	ABB ACS550 Pulse Width Modulated (PWD), variable frequency	ABB ACS550 Pulse Width Modulated (PWD), variable frequency
Voltage	380-480 3-phase	380-480 3-phase
Frequency	50/60 Hz	50/60 Hz
Crankcase (see Changing Crankcase Oil, page 5-36, for additional oil specifications)		
Oil	SAE 30 Non-detergent (ISO 100)	SAE 30 Non-detergent (ISO 100)
Capacity	2 quarts (1.9 L.)	2 quarts (1.9 L.)



Operating the OMAX JetMaching Center

This chapter provides information and instructions supporting operation of the OMAX JetMaching Center. It explains how the pump and abrasivejet system work and provides instructions on starting and stopping the system and doing an emergency shut-down. It also discusses the JetMaching software, explains important tasks to be performed in configuring the machine prior to cutting, lists tips for effective use of your equipment, and outlines the steps involved in the cutting process from equipment power-up to power-down.

Note: *This manual does not provide detailed information on the operation of the OMAX **Make and Layout** software. For instructions on using this software, refer to the OMAX Interactive Reference (the software help screens).*

About Abrasivejet Machining

Industrial abrasivejets have been in use since 1982. An abrasivejet uses water that is pressurized to more than 40,000 pounds per square inch (psi) (2760 bar). This high-pressure water enters at the top of the cutting nozzle and is forced through an orifice assembly containing a round jewel with a small hole in it (see Figure 4-1). Forcing the water through the hole in the jewel accelerates the stream of water up to 2500 feet per second (760 m/s). This fast moving stream moves into a larger chamber, where the speed of the water creates a suction that draws in the flow of abrasive. The abrasive is stored in a hopper on the moving head of the X-Y table. An air-controlled abrasive valve releases a stream of abrasive into a feed tube where it flows to the nozzle. This stream then moves into the mixing tube. The mixing tube has a small hole through the center that serves to contain the water and abrasive as they mix to form an abrasivejet. The mixing tube is made from a hard, brittle material designed to resist abrasion. The water and abrasive are combined into a high-speed slurry at the bottom of the mixing tube. This slurry becomes the cutting tool as the tube focuses the jet stream at high velocity out of the bottom of the tube and onto the material being machined.

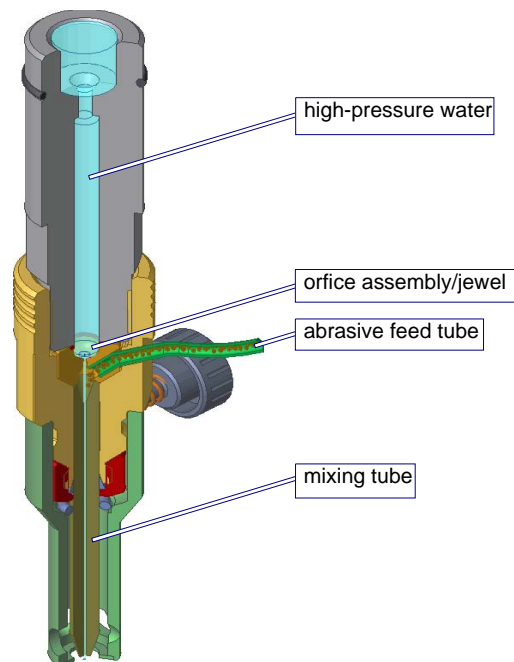

Figure 4-1: The Abrasivejet Nozzle

WARNING! *Keep your hands away from the nozzle whenever it is moving or cutting. The abrasivejet's high-pressure stream can cause serious injury. In addition, nozzle movement can crush fingers and hands caught between it and another object. Cutting with the nozzle out of water is extremely noisy and can damage your hearing! Always wear ear and eye protection when cutting.*

Caution: *Do not operate the abrasive waterjet for more than several seconds when the nozzle is above the water surface at a distance greater than 1.5" (38.1 mm). Air entrapment in the water increases with nozzle height, eventually allowing the jet stream to strike the tank bottom with sufficient force to cut a hole through the bottom. This applies to using "Test Nozzle" and cutting thick materials at a high-quality setting. Always make sure that cutting is done either under water or with the water level immediately below the work piece.*

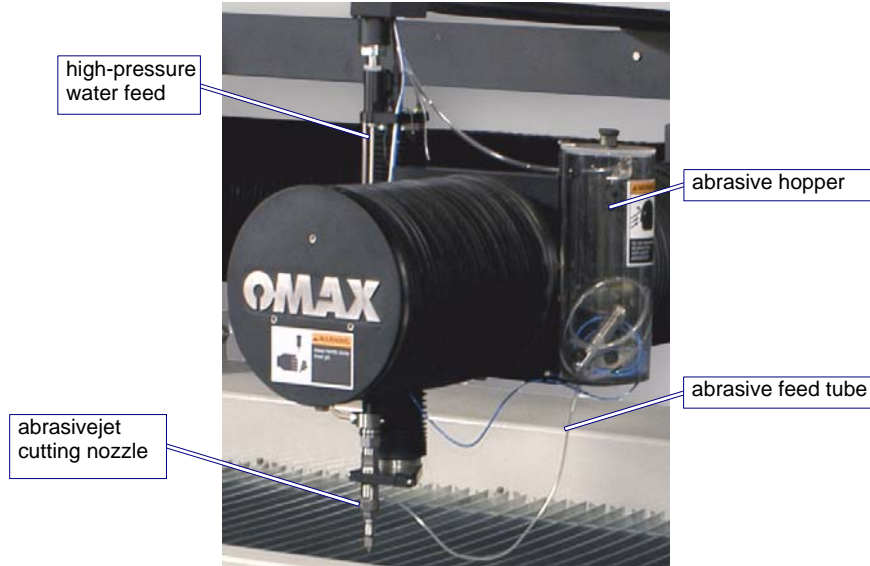

Figure 4-2: The Abrasive Waterjet System

The OMAX Software

OMAX software is used to create part drawings (OMAX **Layout**) and to cut the part (OMAX **Make**). The OMAX software completely controls the operation of the JetMachining Center.

In addition to OMAX **Layout** and **Make**, many other useful utilities are supplied with your OMAX software. Consult the online OMAX Interactive Reference (online help files).

OMAX **Layout** Program

The OMAX CAD module called **Layout** creates parts for cutting. This drawing software includes a full range of drawing and editing tools. DXF files from other CAD programs can be imported into **Layout**. In addition, DXF files can be exported from **Layout** to other CAD programs. The end result of **Layout** will be the creation of an OMAX Routed Data file (ORD), which also contains the machine cutting instructions.

OMAX **Make** Program

The OMAX **Make** software prepares the **Layout** drawing for the cutting process. It calculates the speed of the abrasivejet for optimum results and controls all machining operations. **Make** can calculate how much time and abrasive material will be required to machine the part, and allows you to review the exact path of the abrasivejet, even when not connected to the OMAX JetMachining Center.

OMAX Interactive Reference

The OMAX Interactive Reference (OIR) is an extensive set of **Help files** that document all the features of **Layout** and **Make**. The OIR provides a wealth of information—not only about the commands in the software, but also practical, real-world tips on how to effectively use your OMAX.

There are several ways to access the OIR:

1. Click the **Help** button when using a command.
Many **Layout** and **Make** commands provide a Help button that starts the OIR and opens the page describing that command.
2. Press the **F1** key while in either **Layout** or **Make**.
3. Double-click the desktop **OIR** icon (“OMAX Reference”).
4. Click **HELP** in the **Layout** or **Make** main menu.

Operating the High-pressure Pump

WARNING! *When operating this equipment, always observe the safety precautions listed in Chapter 1 of this document. Failure to do so can result in bodily injury or death.*

When attached to an OMAX JetMachining Center, control is shared between the JetMachining Center Controller and the pump keypad. The JetMachining Center turns the high-pressure pump ON to begin a cut and turns it OFF between cuttings.

Before starting the pump unit:

1. Check the pump's maintenance log and other records for any ongoing service activities. Verify that no “Out of Service” tags are posted on the pump's main electrical disconnect or on its ON/OFF switch. If service is scheduled and necessary, have it completed before resuming pump operation.

WARNING! *Before powering the pump for operation, verify that equipment service is not in progress.*

2. Visually inspect the pump components for damaged parts, leaks, and other conditions that could prevent safe and proper operation. Ensure that the area around the pump is clear of tools and other objects that could block immediate access to controls functions, hindering safety.
3. Verify that the oil level in the pump crankcase is sufficient for operation.
4. Ensure that all pump side panels and enclosures are in place and properly secured.
5. Familiarize yourself with the location and function of the controls identified previously in Figures 3-7 and 4-5.

Start the Pump

WARNING! *Prior to starting the pump, verify that everyone is clear of the high-pressure cutting nozzle.*

1. Open the building's inlet valve that provides water to the pump.
2. Place the main electrical disconnect in the **ON** position.
3. Turn the pump ON/OFF switch to the **ON** position (“I”).
4. Turn the charge pump ON/OFF switch to the **ON** position.

Note: *Always run the charge pump for a few minutes following an initial power up. This flushes out the warmer water, ensuring that the seals are cooled prior to high-pressure pump operation.*

Caution: *The ideal inlet water temperature to operate the pump is between 45° F (7° Celsius) and 60° F (16° C). As the inlet water temperature rises above 70° F (21° C), the pump dynamic seal life begins to drop. Cylinder temperature will begin to rise immediately following a shutdown with the charge pump OFF. Excessive temperatures could easily be reached during a prolonged shutdown. As a precaution following an extended shutdown such as during a lunch break, always run the charge pump for as long as it takes to lower water temperature in the white water tank to that of the inlet water temperature prior to resuming cutting.*

5. Verify that the PC-based controller starts and stops the pump as required for operation.
6. Once the pump starts, verify that the red LED next to the **Run** button on the keypad is lit (see Figure 3-7), and the RPM reading on the display achieves the "Hi PreSet" value.

Set the Pump RPM

The pump RPM, which determines cutting pressure, may be adjusted up or down using the keypad's **arrow** buttons while the pump is either running or not running. Generally, both the high and low-operating pressures are preset with the pump operating in a test mode.

1. To increase the high-pressure value, press the keypad's **up** arrow.
The "Hi PreSet" RPM value will increase. If the pump is running when this arrow button is pressed, the pressure shown on the keypad display also increases. When the pump is running and the "Hi PreSet" RPM results in an output pressure greater than the maximum allowed, the RPM value decreases to conform to the maximum allowable pressure. The display screen will then repeatedly flash the message "@MAX".
2. To decrease the high-pressure value, press the keypad's **down** arrow.
The "Hi PreSet" RPM value decreases. If the pump is running when this arrow button is pressed, the pressure shown on the keypad display also decreases.
3. The pump control has a "Low PreSet" RPM mode for low-pressure operations with the OMAX JetMachining Center. This is useful for piercing brittle materials or etching and scribing materials at reduced pressure.
4. The "Low PreSet" RPM value is set by pressing and holding the keypad's **Reset** button while also pressing either the **up** or **down** arrow button. Attempts to set the RPM lower than 700 RPM causes the display to repeatedly flash the message "@MIN". The low RPM mode can be activated only by a signal from the JetMachining Center controller.

Set the Adjustable Dump Orifice (ADO)

The Dual ON/OFF Valve controls water flow through the cutting nozzle (Figure 4-3) and operates in conjunction with the adjustable dump orifice (Figure 4-4) installed in the OMAX high-pressure pump.



Figure 4-3: Dual ON/OFF Valve with MAXJET®5 Nozzle

When the nozzle is no longer cutting and the high-pressure water shuts OFF, the software automatically re-routes this water through the pump's dump orifice until the nozzle is again turned on and resumes cutting. This action allows a continual pump operation during times when the nozzle is not cutting and assures that the water pressure always remains the same, allowing the starting and stopping of the waterjet stream to take place without delay. This technique also enables dual pressure operations, as required for low-pressure glass piercing, for example, by opening both the dual ON/OFF valve and the valve for the dump orifice simultaneously.

Matching nozzle pressure with the pressure of the adjustable dump orifice is important in preventing damage to ultra high-pressure components. Ideally, at the end of a cut, water pressure gently will fall to the traverse pressure, and, at the end of the traverse, the pressure will rise to the cut pressure without overshooting the mark.

The cutting head pressures observed when the machine is actually cutting should be 3-5 KSI above the dump orifice pressure. Dump orifice pressures are observed when the machine is traversing towards the next cut. For example, a cutting head pressure observed at 50 KSI should see traverse pressures of about 46 KSI.

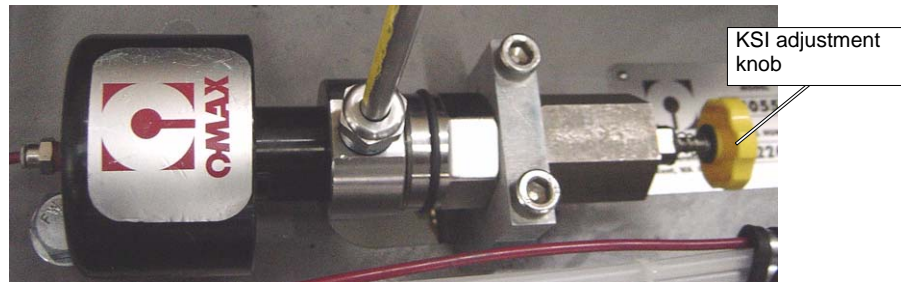

Figure 4-4: The Adjustable Dump Orifice used in OMAX Pumps

To equalize the ADO pressure with the nozzle cutting pressure, follow these procedures:

1. Power up both the pump and PC-based controller.
2. Open the pump's top lid to access the knob on the ADO.
3. To ensure the valve stem is correctly positioned once the pump starts, screw the wing nut towards the knob until the spring makes initial contact with both the wing nut and knob (Figure 4-5).
4. Screw the knob into the ADO body until the wing nut makes contact with the ADO body.
5. Hold the knob, preventing it from turning, and screw the wing nut back towards the knob, leaving approximately a 1/4th inch gap between the ADO body and wing nut. This gap provides the necessary adjustment room for the knob. If not enough gap is available, the wing nut will contact the ADO body too soon, preventing the knob from being adjusted any further. If this happens, simply unscrew the wing nut away from the ADO body to allow more adjustment travel.

Caution: *The Adjustable Dump Orifice was not designed to close completely as a "needle valve" would. NEVER screw the adjustment knob all the way in clockwise and force the tapered stem into the tapered seat. Doing so may jam the stem into the seat, requiring that the ADO be disassembled to unjam the stem.*

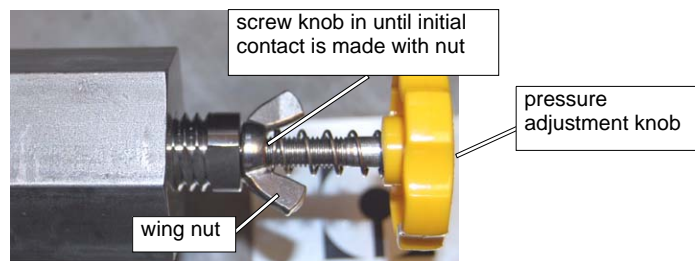

Figure 4-5: Prior to Applying High Pressure, Position the Knob to Just Touch Its Spring

Caution: *The safety valve may fire due to excessive pressure if the pump runs with the nozzle shut OFF and the ADO valve completely closed.*

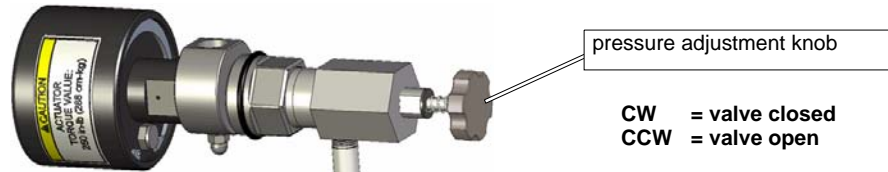

Figure 4-6: The ADO Pressure Adjustment Knob

6. Launch the OMAX **Make** software and position the nozzle to accommodate a high pressure, water-only test.
7. In **Make**, click the **Test** button to view the **Test Pump and Nozzle** window options:

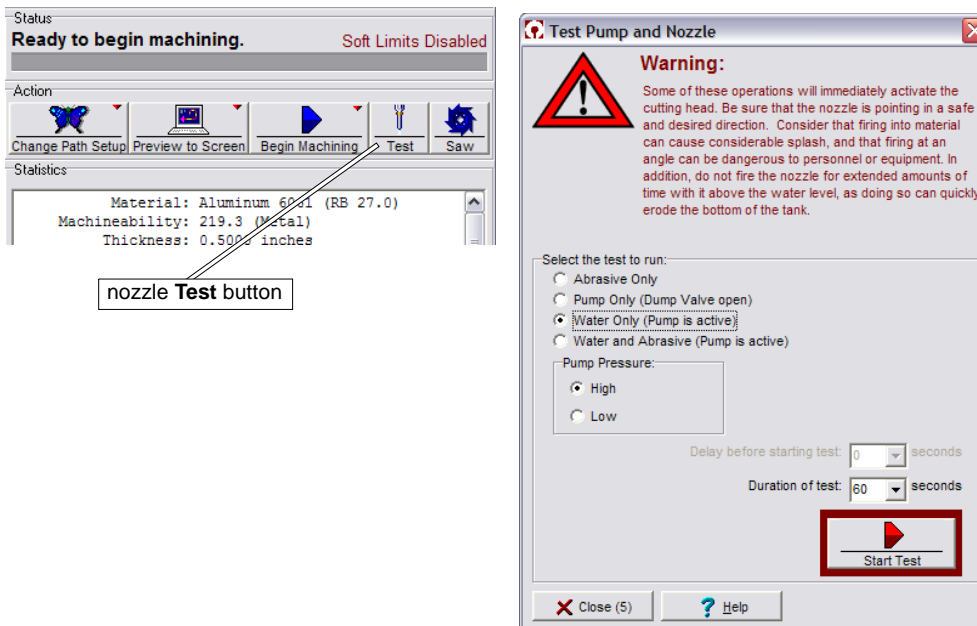

Figure 4-7: Click the Test button to open the Test Pump and Nozzle dialog box

8. In **Test Pump and Nozzle**, select **Water Only (Pump is active)** and either **Low** or **High** depending on your desired cutting pressure.

WARNING! *The cutting head is about to turn ON. For safety, ensure that the nozzle is positioned correctly and everyone is clear of the cutting area.*

9. Click the **Start Test** button to start the pump and fire the nozzle.
10. On the pump control panel, use the **UP** and **DOWN** arrow keys to set your desired cutting pressure while the nozzle test is active:



Figure 4-8: Set the KSI for **WaterPres** on the Pump's LCD

- When your desired water cutting pressure is set, click **STOP** to halt the test and remove nozzle pressure:

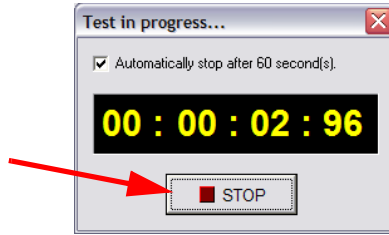

Figure 4-9: Click the Test **STOP** Button After Setting Your Desired Pump Pressure

- Again, click the **Test** button (Figure 4-7) and this time select **Pump Only (Dump Valve open)** and either **Low** or **High** depending on your previous selection (step 8).

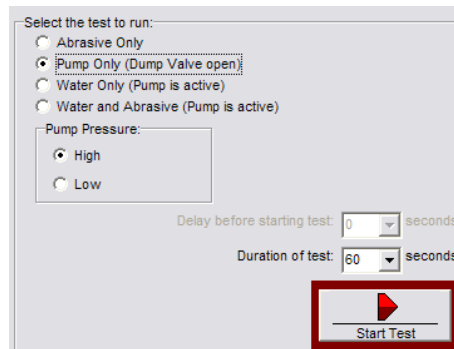

Figure 4-10: Click **Start Test** to Pressurize the Adjustable Dump Orifice

- Click the **Star Test** button to activate the pump.
- At the ADO, turn the Pressure Adjustment Knob (Figure 4-11) until the pressure indicated on the pump's control panel LCD (Figure 4-8) equals the **KSI** set previously in Step #10 above.

Note: A 3/16" Allen wrench inserted into the end of the knob will assist in fine tuning the ADO pressure adjustment.



Figure 4-11: Using a 3/16" Allen Wrench to Adjust the ADO Pressure

Note: The ADO pressure should equal the nozzle pressure, but must never be allowed to exceed nozzle pressure. Also, ADO pressure should not be more than 2 KSI below nozzle pressure.

WARNING! *Never continue unscrewing the adjustment knob until it's able to detach itself from the ADO body while the water is under pressure.*

- Once the correct pressure is set, hold the knob in place to prevent it from rotating, then tighten the wing nut to lock the knob in position.
- Click the **Stop** button (Figure 4-9) to halt the test.

17. Replace all removed pump panels and close the pump lid.
18. Adjustment of the ADO pressure is complete.

Note: *The ADO pressure will require readjusting anytime a different sized orifice is installed in the nozzle, or a defective or worn jewel is replaced with a new one.*

Stopping the Pump

1. Press the keypad's **Stop** button.
2. If the pump is connected to an OMAX JetMachining Center, the PC-based controller automatically starts and stops the pump as required during operation.

Note: *The pump may be stopped at any time by pressing the **emergency stop switch**, either on the pump or on the JetMachining Center controller.*

3. When the pump stops, verify that the red LED next to the keypad's **Stop** button is lit (see Figure 3-8).
4. Turn the charge pump switch to its **OFF** position.
5. Turn the pump ON/OFF switch to its **OFF** position.

Emergency Shutdown Procedures

Pushing the emergency stop switch in, immediately shuts down both the pump and the JetMachining Center. The emergency stop switch is reset by manually pulling it back to its original position. The pump cannot be restarted until the emergency stop switch is reset.

Operating the JetMachining Center

Note: *The following guidelines for operating the JetMachining Center assume that the OMAX operator has received the factory training provided as part of the original equipment purchase and installation.*

Configure Your Drawing

1. Import your part file (.dxf) into **Layout**, the OMAX drawing tool.
2. Use the **Clean** command to clean up the drawing file by removing any unnecessary dots, closing any gaps, and removing any duplicate entities.
3. Define the quality of the cut needed for each part entity (see Determine a Cutting Quality on page 4-9):
 - Quality 1 is the lowest quality cut and the fastest.
 - Quality 5 is the highest quality cut and the slowest.
4. Add nozzle **lead ins** and **lead outs** to the cutting path.
 - Lead ins are typically drawn longer; lead outs are drawn shorter.
 - The side of the entity where you placed your lead in/outs determines whether the nozzle cuts on the left or right side of the entity.
 - The nozzle travels in the direction of the least sharp turn (the widest angle) on the lead in.
 - Always verify your lead in and lead out configurations in **Layout**.
 - Use a 90° lead in and lead out on square corners.
 - Use a narrow angle on the lead in/lead out to minimize witness marks or blemishes.
5. Save the completed version of your .dxf file.
6. Use the **Layout** Path Special Tool to specify the machine path.
 - Configure the path either manually or automatically.
 - Render as a Solid to verify the outcome.

- Run collision detection and correct any found.
7. Save your final path drawing. **Layout** automatically saves it as an OMAX ORD file.

Note: Consult the OMAX Interactive Reference for a detailed **Layout** tutorial and any additional drawing information.

Determine a Cutting Quality

Each entity in a drawing is assigned a quality value (1-5) which controls how quickly the abrasivejet nozzle moves when it cuts the piece. The slower the abrasivejet nozzle moves, the higher the quality of a cut. At the highest quality (5), the abrasivejet nozzle moves the slowest. Quality also takes into account the material being cut. When working with a softer material such as polypropylene, for example, a quality of 5 moves the abrasivejet nozzle much faster than a quality of 5 would while working with steel. Quality is always relative to the machineability of the material.

Figure 4-12 shows how the surface finish changes with the quality assigned. As the quality number goes lower, the cutting speed becomes faster, and the cut surface becomes less and less smooth.

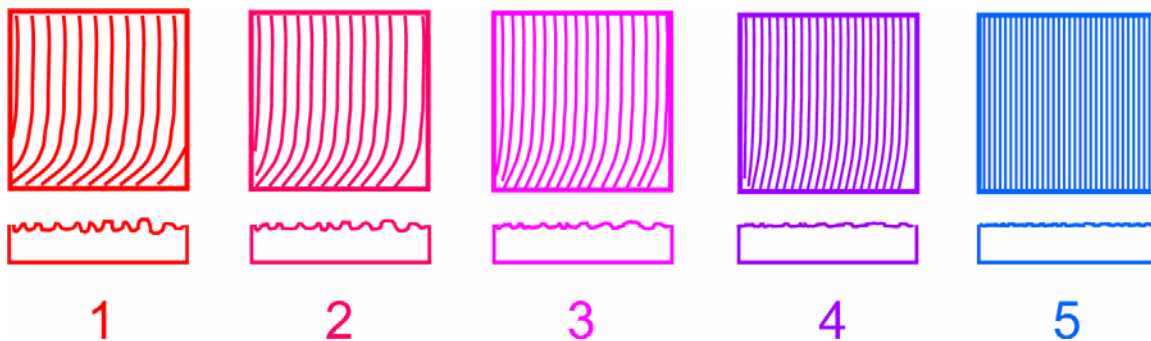

Figure 4-12: Quality Examples

In most cases, setting the cutting quality is a compromise between achieving the best surface finish in the least amount of time. When deciding which quality to use on a new material, a quality of 3 is a good choice. If the finish is too rough, increase the quality number. If the finish is acceptable, try lowering the quality to see if the part can be made in less time.

Four of the available types of qualities—Etch, Scribe, Water Only, and Lead—are different types of qualities. Etch and Scribe are designed to mark the surface of a material (to add a part number, for example). Water Only is designed for materials that can be machined without add an abrasive. Lead is assigned to a cutting path's lead ins and lead outs.

Clamp and Position Your Materials for Cutting

Large clamping forces are not ordinarily needed to secure material to the cutting table, but the material must not be allowed to move as it is being machined. One of the primary causes for out-of-tolerance parts is allowing the material to move while being cut.

WARNING! *Always be careful when handling material in the OMAX tank. During normal usage, the abrasivejet cuts into the support slats and their edges can become extremely sharp. Avoid situations where your fingers can become pinched between the cutting material and a support slat. Wear protective gloves!*

A small downward force (about one pound or 4 newtons) is exerted on the material from the abrasivejet stream; however, a much larger upward force is exerted from all the air forced down with the abrasivejet stream. Once released, this air pushes upwards against the material.

The best way to secure material is to clamp it against the frame or tank. Never clamp material to the slats themselves. Slats can sway back and forth slightly, moving the material with them. Use the slats only for

vertical support. The larger the surface area of the material being cut, the more securely it must be clamped since the upward force from the jet stream's captured air will have more material to push upon.

Note: *The size of the high-pressure water pump also affects the clamping required. If the pump power is doubled, the amount of force exerted on the material will also double.*

WARNING! *Always use the proper lifting equipment when handling heavy materials.*

Use Tabs for Holding Small Parts

When cutting small parts, design them using small holding tabs that prevent the part from detaching and slipping past the slats and down into the tank. Slats in the OMAX are spaced 1" (2.5 cm) apart. Small parts can easily slip between these slats once cut free. Designing tabs to hold a part to the cutting material prevents this. After the cut is complete, it can be broken free and the tab filed smooth. Tabs can be as thin as 0.030" (0.8 mm), depending on the material being used. Several tabs may be used on small parts to hold them steady if the part requires intricate detail work.

Note: *Using Waterjet Brick for holding small parts is an effective alternative to designing tabs.*

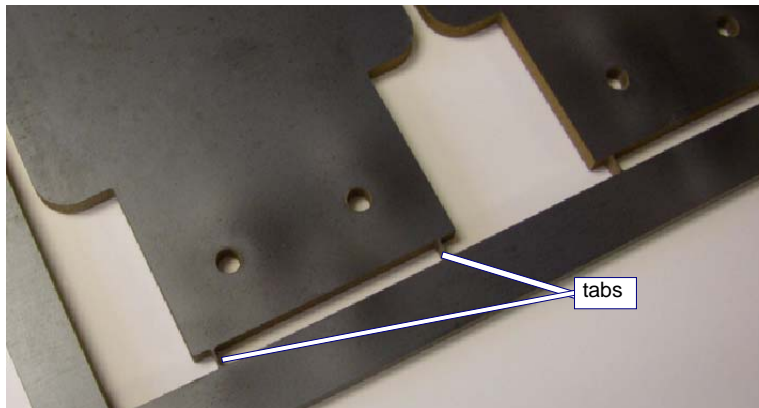

Figure 4-13: Using Tabs Prevents Small Parts from Falling in the Tank

WARNING! *Never place your hands in the tank for any reason while the nozzle is operating. Never hold a part with your fingers while the nozzle is operating!*

Set Machine Limits

In the OMAX, there are two types of limits that restrict the area of nozzle movement on a table's cutting surface: *absolute* limits (hard) designed into the machine's hardware and user-defined *soft* limits.

Absolute Limits define the maximum cutting area that is available on a particular table. These are hardware limits that are set using physical stops installed on the ends of the ball screw threads or traction drive rails for both the X and Y-axis (Y=0, X=0 points). Although the cutting head can be commanded to reach these absolute limits, this seldom is done since this frequently is where the cutting head would crash into the side of the table and cause serious equipment damage, especially if the crash is done at full speed.

Soft Limits are software defined to prevent the cutting head from reaching the table's absolute limits or to avoid hitting other fixtures placed within the cutting area. These limits can be set to create a smaller working area within the available maximum cutting area. When a soft limit is reached, a controlled stop is immediately initiated that prevents further cutting head movement. Whenever a nozzle movement is commanded that will exceed a defined soft limit, a window pops up warning the operator that set limits will be exceeded. When using the keyboard to move the cutting head manually and a soft limit is reached, the software immediately halts head movement using a controlled slowdown and stop that prevents the nozzle from exceeding a user-defined soft limit.

Cut Your Parts

WARNING! *Safe operation of this equipment requires that you have read and can practice all the safety “dos” and “don’ts” presented in “Chapter 1: Safety First.”*

Set Up the Hardware

1. Before powering up this equipment, ensure that you and other operators have access to the required protection devices (safety glasses, ear plugs, and rubber gloves).
2. Switch the main power breaker **ON** for your OMAX equipment.
3. If installed, close the bleed valves on the bulk hopper and common water air tank.
4. Switch the air supply valve **ON**.
5. Switch the water supply valve **ON**.
6. Check the white water tank inside the pump (Figure 4-14) to verify the water level is between one-half and three-fourths full.
7. Power up the OMAX high-pressure pump as follows:
 - a. Turn the pump control panel switch **ON**. Verify pump operation by checking for valid RPM and KSI readings on the pump's LCD screen.
 - b. Turn the charge pump control panel switch **ON**. Inspect the cooling flow from the three hoses in the white water tank for a similar flow from each. When holding each horizontally, the water should stream out 2-4" before dropping.

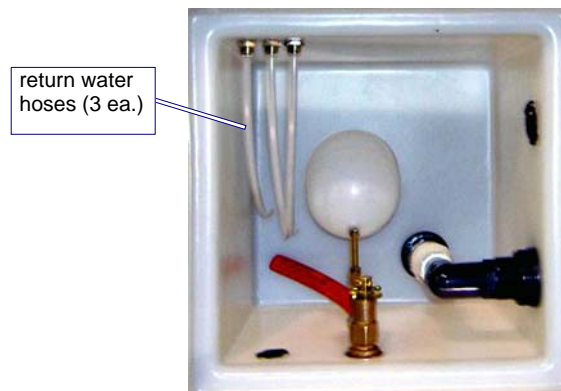

Figure 4-14: White Water Tank Internal View

WARNING! *Always run the charge pump for approximately 15 minutes following its initial power up and when the pump has been inactive for 30 minutes or more. This allows cool water to circulate and cool off the dynamic seal area of the pump, ensuring that pump seals are cooled down prior to high-pressure operation.*

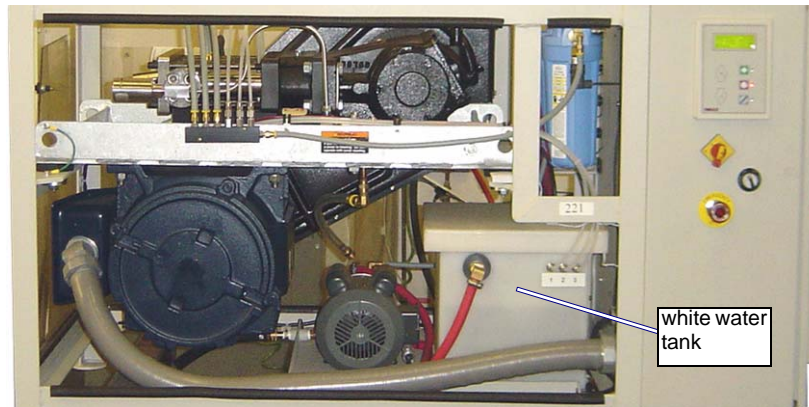

Figure 4-15: White Water Tank Location in OMAX Pump

- c. After running the charge pump for 15 minutes, measure the water temperature of the white water tank. It must always be maintained below 70° F (21° C). The colder the better!

Caution: *If your inlet water is above 60° F (16° C), you may experience a shorter life from your pump seals. If the temperature is above 70° F (21° C), a chiller will be required. It is important to understand if the metal in the pump cylinders ever exceeds 80° F (27° C), the first 5 minutes of running could destroy a possible 100 hours of seal life. Continue doing this for 5 days in a row, and the pump will need a rebuild.*

8. Power up the JetMachining Center by switching the PC-based controller's power ON. Verify that the Windows operating system boots up without issues.
9. When applicable, also power ON any attached OMAX accessories (solids removal system, bulk feed hopper, chiller, etc.).
10. Verify the nozzle being used matches the size required for the part being cut. Change it to the correct size when required.

Caution: *Changing the nozzle orifice size also requires resetting of the adjustable dump orifice (ADO) in the high-pressure water line of the OMAX pump. Correctly matching the nozzle pressure with that in the ADO minimizes water pressure difference in the high-pressure plumbing during nozzle OFF and ON conditions, thus reducing pressure spikes and premature plumbing failures. See page 4-4 for ADAO adjustment procedures.*

11. Ensure that your mixing tube has been installed properly using the nozzle/mixing tube gauge as illustrated below in Figure 4-16:

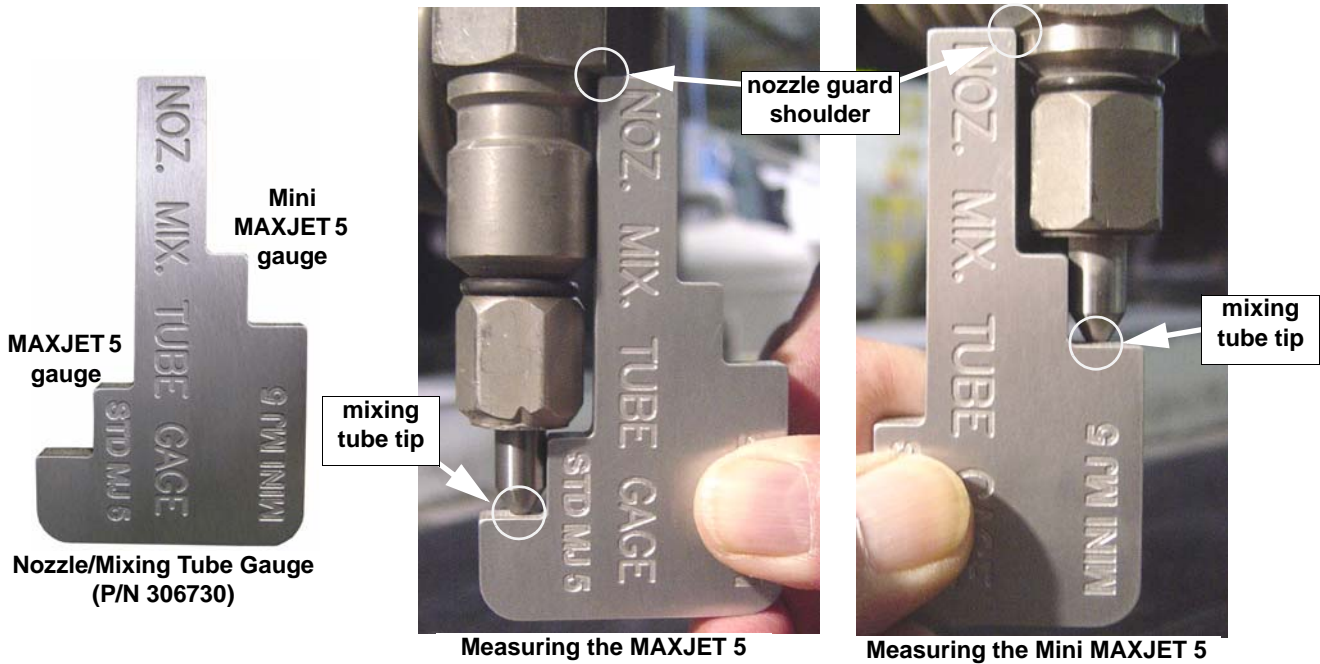

Figure 4-16: Verify Correct Mixing Tube Placement

- Verify that the gauge touches both the **mixing tube tip** and the **nozzle guard shoulder**.
- Verify that no gap exists at either location.

Note: *If a gap greater than 0.010" is seen at either location, it is recommended that you disassemble the nozzle, clean all the components, re-assemble the nozzle, ensure that the mixing tube is pushed in all the way, and recheck for correct mixing tube placement using the nozzle/mixing tube gauge.*

12. Pour the desired abrasive size (mesh) into your nozzle hopper. Ensure that the amount added will be sufficient to finish cutting the part.
13. Check the tank's water level. Make sure that the material being cut can be covered and also uncovered with tank water. Add or drain tank water as needed.
14. In Windows, click the OMAX **Make** icon to launch the cutting software.
15. Auto Home the machine to ensure that the machine's zero (absolute home) position is set (Figure 4-17).

Caution: ***Prior to auto homing the machine, ensure that the Z-axis height is high enough to prevent nozzle movement from striking the table sides. Also ensure that the nozzle is within 1 foot (30.5 cm) of the home position.***

Note: *Auto Homing is the process of locating a table's Absolute Home. All homes are related to Absolute Home and is the only home position that can be lost. Re-setting Absolute Home resets all other homes to their correct positions. To ensure positioning accuracy, Absolute Home must always be re-zeroed before another home is created. It is important that Auto Home be run to re-zero Absolute Home at the beginning of each work day and whenever you shut down for maintenance or reboot the PC-based controller. Absolute Home is usually in the front corner of your machine. For the 80160, Absolute Home is in the rear, far corner of the machine.*

- a. To auto home your OMAX, move the cutting head to about 10" for each axis from the Home corner.
- b. In **Make**, click **Homes/Advanced/Auto Home...**

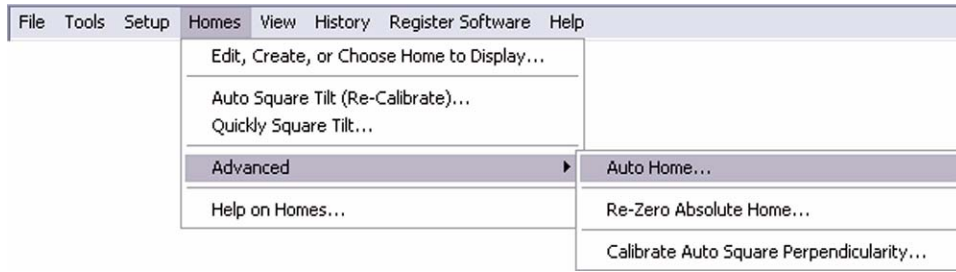

Figure 4-17: Selecting Auto Home in OMAX Make

- c. When the warning message appears, if appropriate, click **OK**.

Note: The machine will now move in the X-axis direction until it gently contacts the X-axis hard stop. It then moves in the Y-axis direction until it gently contacts the Y-axis hard stop.

- d. When prompted to re-zero Absolute Home, select **Yes**. Your OMAX should now be accurately aligned and ready for use.

16. Verify that the soft limits are enabled (**Setup/Advanced/Soft Limits** - see Figure 4-18):

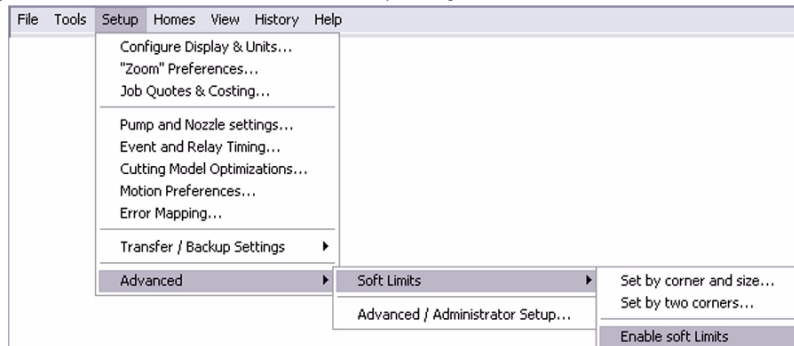

Figure 4-18: Use Setup to Enable the Soft Limits

- 17. Position the nozzle between two table slats at 1 (.254 cm) to 1.5" (3.81 cm) above the water surface.

WARNING! Always use ear protection when operating the abrasivejet nozzle out of water.

18. Test nozzle operation at **Low Pressure**:

- a. Click the **Test** button to display the **Test Pump and Nozzle** options:

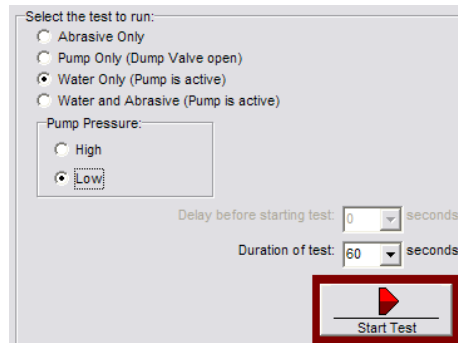

Figure 4-19: Pump and Nozzle Test Options

- b. Select **Water Only (Pump is active)** and **Low**, then click **Start Test** (Figure 4-19).

- c. When the jet stream begins, remove the abrasive feed tube from the abrasive feed block on the abrasive control valve (Figure 4-24) and block air flow through the feed tube by holding a finger against the tube opening. Then, examine the quality of the jet stream as illustrated below:

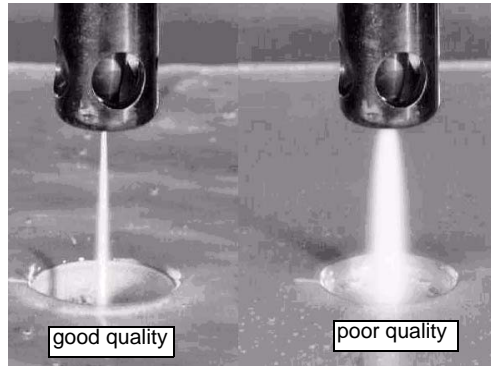

Figure 4-20: Example of Both Good and Poor Quality Jet Streams

Note: Always block the abrasive feed tube prior to visually inspecting the jet quality. Air from this tube interferes with the jet stream, making inspection difficult.

- d. Refer to Figure 4-21 to compare the effect that a damaged orifice and worn mixing tube have on the quality of a nozzle's jet stream.

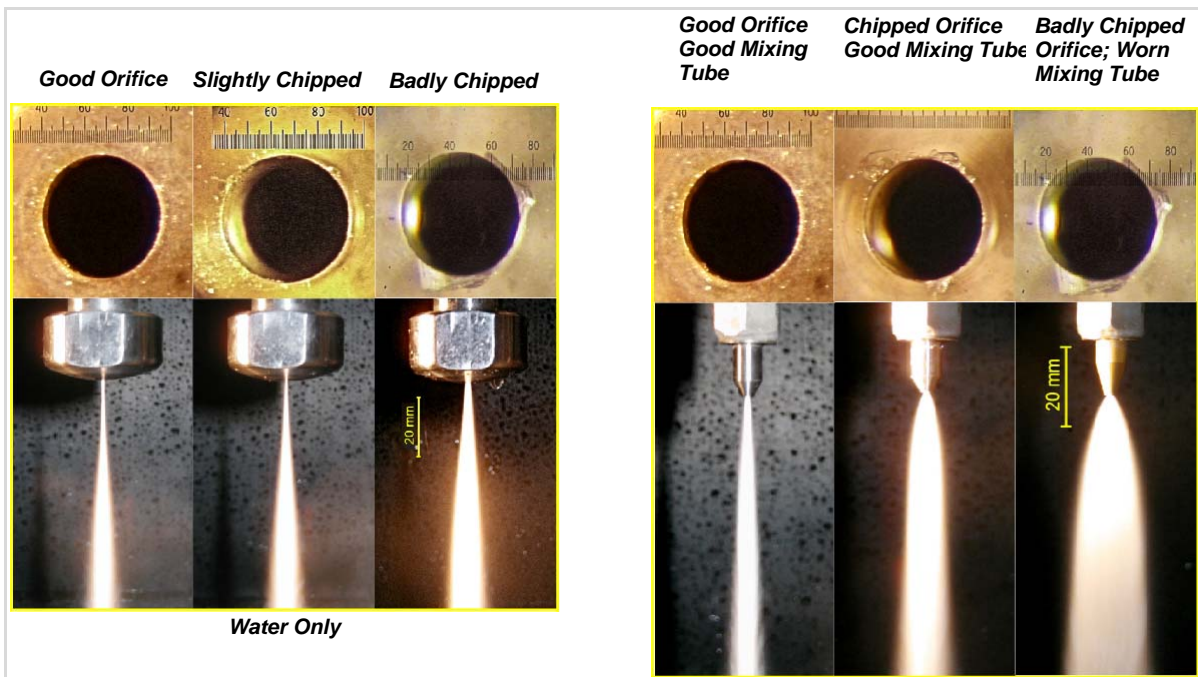

Figure 4-21: Comparison of Jet Streams with Different Jewel and Mixing Tube Conditions

- e. Refer to Figure 4-22 to see how the shape of a jet stream's shape indicates the quality of its cutting performance.

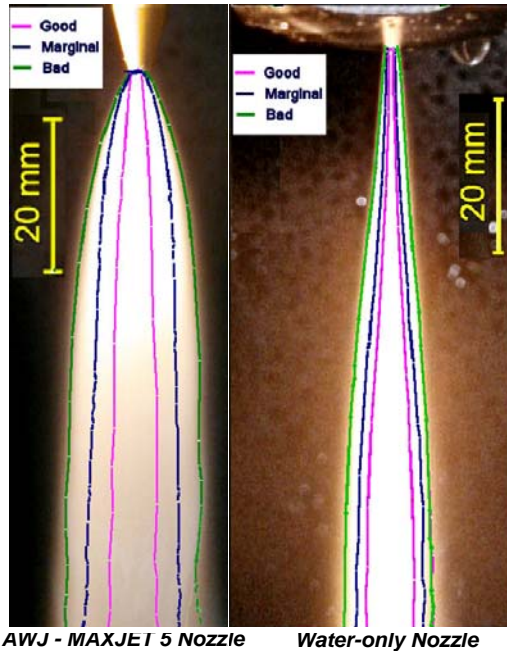

Figure 4-22: Comparison Spread of Waterjets and Abrasive-waterjets at Different Health States

- f. During this jet stream test, adjust the pump RPM to develop the desired low pressure, then write down the pump RPM and KSI values from the pump LCD display screen for the low-pressure test.
- g. If still running, click **Stop** to end the low-pressure pump test:

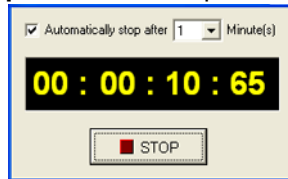

Figure 4-23: Nozzle Pressure Test Stop Button

19. Test nozzle operation at **high-pressure**:

Caution: *Do not operate the abrasive waterjet for more than several seconds when the nozzle is above the water surface at a distance greater than 1.5" (3.81 cm). Air entrapment in the water increases with nozzle height, eventually allowing the jet stream to strike the tank bottom with sufficient force to cut a hole through the bottom. This applies to using "Test Nozzle" and cutting thick materials at a high quality setting. Always make sure that cutting is done either under water or with the water level immediately below the work piece.*

- a. If necessary, click the **Test** button to again display the nozzle test options (refer back to Figure 4-19).
- b. Select **Water Only (Pump is active)** and **High**, then click **Start Test** (see Figure 4-19 for options).
- c. When the jet stream begins, pinch the **abrasive feed tube** until blocked to examine the quality of the jet stream, verifying that it's straight and narrow as illustrated in Figure 4-20.

Note: *Always plug the abrasive feed tube by pinching prior to visually inspecting the jet quality. Air from the tube interferes with the jet stream, making inspection difficult.*

- d. During this jet stream test, adjust the **pump RPM** to achieve the desired high pressure then write down the pump RPM and **KSI values** from the pump LCD screen for the high-pressure test.
 - e. During this test, also check the **charge pressure** at full flow. The difference between the two pressure gauge readings must not exceed 20 pounds. If more than this, the water filters most likely require changing.
 - f. Click **Stop** to end the high-pressure pump test (Figure 4-23).
20. Test nozzle operation using **Water and Abrasive**:
- a. If necessary, click the **Test** button to display the nozzle test options (refer back to Figure 4-19).
 - b. Select **High**, then click **Water and Abrasive** to begin the test (see Figure 4-19).
 - c. Verify an increase in the **sound level** and **stream diameter** from the abrasive flow.
 - d. Click **Stop** to end the Water and Abrasive Test (Figure 4-23).
21. Measure the **abrasive flow rate**:

Note: *The abrasive flow rate should be measured each week (or sooner, whenever there are operational changes).*

- a. Remove the **abrasive feed block** from the abrasive control valve cylinder (Figure 4-24) by pulling it straight back.

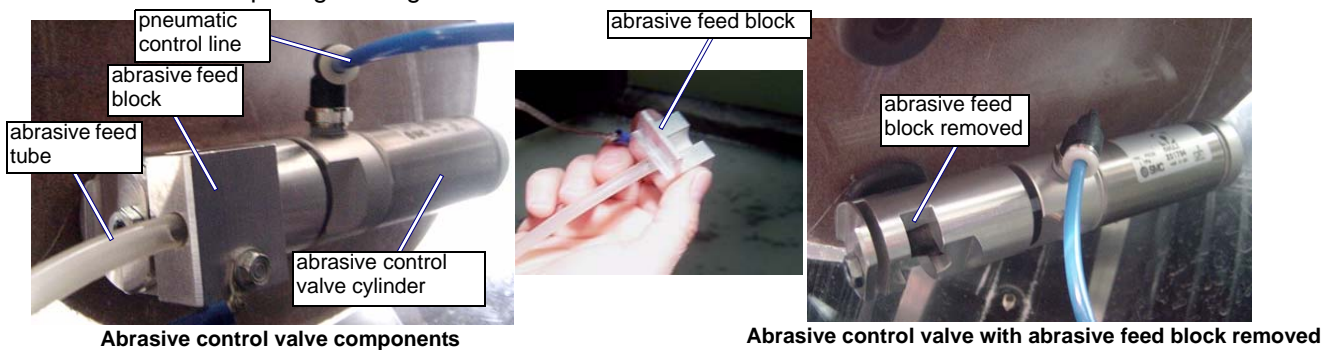

Figure 4-24: Abrasive Control Valve and Abrasive Feed Block

- b. Place a container directly below the abrasive control valve to catch the abrasive released during the measurement flow.
- c. Click the **Test** button to display the nozzle test options (refer back to Figure 4-19).
- d. Click **Abrasive** to begin the abrasive flow.

Note: *By default, the abrasive flow automatically stops after one minute.*

- e. With an accurate scale, weigh the abrasive collected in the container during the one minute flow and record the abrasive weight in pounds. **Do not include the weight of the container!**
- f. Replace the **abrasive feed block** by pressing it back into the abrasive control valve.

22. Verify that the "Pump Nozzle Settings" in **Setup** match your actual measured values.

Caution: *It is critical that the software settings match your actual MEASURED values for the pump pressures and abrasive flow rate. Also, it is critical that the nozzle setup exactly match the nozzle installed on your machine. If not properly matched, poor cutting and frustration results.*

- a. Click **Setup** in **Make** and select **Pump and Nozzle Settings...**:

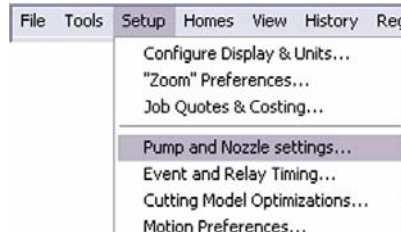

Figure 4-25: Setup Menu for Pump and Nozzle Settings

- b. Correct any values being displayed that differ from those recorded when testing your OMAX machine.

Pressure at Pump in High Pressure Mode:	3447.3785	Bar
Pressure at Pump in Low Pressure Mode:	1378.9514	Bar
Jewel (orifice) Diameter:	0.3556	mm
Mixing Tube Diameter:	0.762	mm
Abrasive Flow Rate:	0.4535924	Kg/min
Abrasive Size:	80	Mesh (US Standard)
Abrasive Index:	1	(Use 1.0 for garnet)

Figure 4-26: Settings for Pump and Nozzle

- c. Click **OK** to save any changes made.
23. From **Setup**, click **Event & Relay Timing**. Make sure that the values displayed are correct for your machine and cutting situations. Click **OK** to save any changes made.

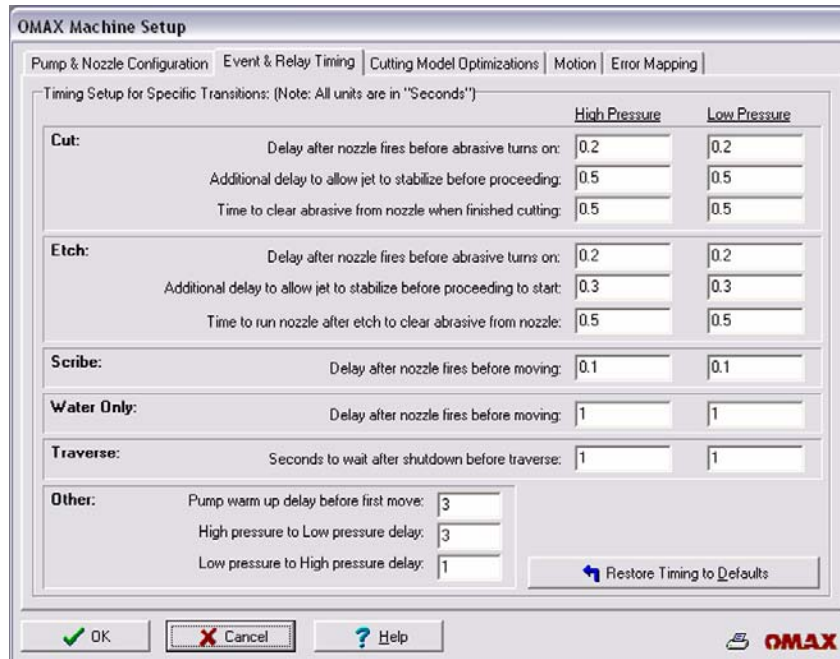

Figure 4-27: Event and Relay Timing Displayed Values

Note: For determining values for Event and Relay Timing, it is best to start with the default values and then adjust these values to match your own requirements.

- 24. From **Setup**, click **Cutting Model Optimizations** and verify that those selections match your cutting requirements. Click **OK** to save any changes made.

Configure the *Make Software*

1. Select the drawing for your part:
 - a. Click the **Change Path Setup** button (or use **File/Open (Change Path Setup)** from the menu bar) and follow the path to where your drawing's file is stored.
 - b. When located, clicking the **ORD file name** opens that drawing in the adjacent preview screen.

Note: *If your drawing was developed using another PC other than the OMAX PC-based controller, unless networked, you must move it to the PC-based controller by copying it to a CD, diskette, or USB memory stick.*

2. From the same window previously opened by clicking **Change Path Setup** (step 1a above), enter your **Material Setup** values:

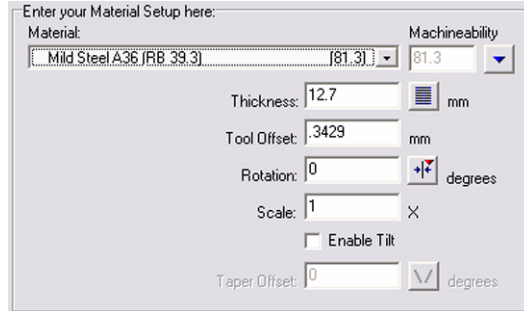

Figure 4-28: Material Setup Example

3. If required, also configure the **Cut Settings** and **Pierce/Terrain Follower Settings**:

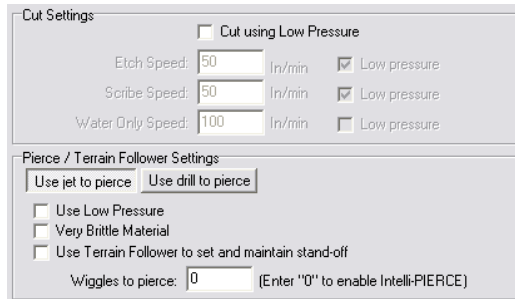

Figure 4-29: Cut, Pierce, and Terrain Follower Setting Options

Cut the Material

1. Move the nozzle to an out-of-way area on the table that allows ample working room for the material to be placed and secured to the table.
2. Lower the tank water level to just below the table slats.
3. Place the material to be cut on the slats and use adequate fixturing to keep the material flat and stable during cutting.

Note: *Ensure that small parts do not fall into the tank as they are cut free. Either use Waterjet Brick, position the cut appropriately, or utilize tabs. Refer to Clamp and Position Your Materials for Cutting on page 4-9.*

4. Position the nozzle to begin the cut and set the Path Start Home:
 - a. Place the nozzle above the material being cut, ensuring efficient use of the available material and where it will not overshoot the material during the cut.
 - b. Once the nozzle is correctly positioned, click **Zero** as the **Distance from Path Start** (see Figure 4-30).

Note: This step may be omitted, as the distance from path start is always zeroed automatically when the cut is initiated.

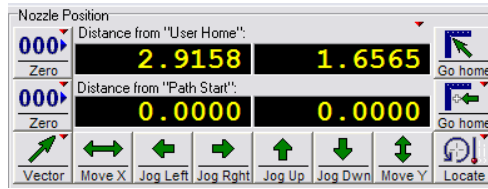

Figure 4-30: Nozzle Position Functions

5. Set your nozzle standoff above the material between 0.040" and 0.060" (0.060" required for the Tilt-A-Jet) and **zero** the Z-axis:
 - a. Press **1** to move the nozzle **down** quickly; press **7** to move it **up** quickly.
 - b. Press **PageDown** to move the nozzle **down** in 0.1 inch (.254 cm) increments; **PageUp** to move it **up**.
 - c. Adjust the **nozzle height** between 0.040" and 0.060" (0.060" required for the Tilt-A-Jet) above the material by placing a gauge between it and the material being cut and adjusting the Z-axis up or down appropriately.
 - d. When properly adjusted, click **View/Show Z Coordinates** to display the Z Height Coordinates pop-up window:

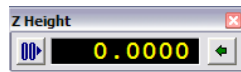

Figure 4-31: Z-axis Height

- e. On the **Z Height** display (Figure 4-31), click the **00** button to set the Z coordinates at zero.
6. Conduct a dry run to verify your cutting path:
 - a. Click the **Begin Machining** button to display the OMAX Path Control window.
 - b. *Right-click* the **Start** button to display the options window.
 - c. Click **Dry run at full (Rapid transverse) speed...** (or another speed of your choice) to initiate the dry run.
 - d. Verify the nozzle travels over the material to be cut as expected.
 - e. If necessary, correct your **Path Start Home** position and try another dry run.
7. Raise the nozzle using the Z Height adjustment and attach the nozzle's muff.
8. Lower the nozzle to its zero Z-axis coordinates (click the arrow on the right side of the Z Height pop-up display).
9. Raise the water level in the tank above the cutting material.
10. Begin cutting by clicking **Begin Machining/Begin**.

Caution: *Always remain near the JetMachining Center during the cutting process. In the event of a serious problem, use the Emergency Stop switch to immediately halt operations.*

11. Once machining stops, raise the nozzle, lower the water lever, rinse the abrasive debris from the cut material, and remove the cut part(s) from the machine.

Shutting Down the JetMaching Center

1. Position the nozzle between two table slats at 1 (.254 cm) to 1.5" (3.81 cm) above the water surface.
2. Allow the pump to run for 20 seconds to clean and clear all abrasives from the nozzle:

Caution: *Do not operate the abrasive waterjet for more than several seconds when the nozzle is above the water surface at a distance greater than 1.5" (3.81 cm). Air entrapment in the water increases with nozzle height, eventually allowing the jet stream to strike the tank at full force and possibly cut a hole through the tank bottom.*

- a. Click the **Test** button to display the Test Pump and Nozzle test options:



Figure 4-32: Pump and Nozzle Test Options

- b. Select **Water Only (Pump is active)** and **High** pump pressure, then click **Start Test** to begin the jet stream.
 - c. After at least 20 seconds click **STOP** to halt the jet stream.
3. Lower the tank **water** to its lowest level.
 4. Move the nozzle to a table area where it will be out of the way during cleanup.
 5. Wipe down the machine table and surrounding area, cleaning up any splashed water and abrasive material.
 6. Remove any debris floating in the water.
 7. Complete any shop-specific clean-up procedures.
 8. Remove any discs or USB memory devices that may still be in the PC-based controller.
 9. For a Terrain Follower, secure the foot in its Up position using a bungee cord or similar device.
 10. Close OMAX **Make** and all other software applications running on the OMAX PC-based controller.
 11. Click the Windows **Start** button and select **Shut Down**.
 12. Verify that the computer has powered down (indicator lights OFF and a blank screen).
 13. If applicable, depressurize the **Bulk Feed Hopper**.
 14. Turn the charge pump **OFF**.

15. Switch the water supply valve **OFF**.
16. Power the PC-based controller **OFF**.
17. Switch the air supply valve **OFF**

Caution: *NEVER turn the PC-based controller power OFF without first shutting down the PC using the proper Windows shut down procedures (Start/shutdown). Always wait for the PC to completely shut down before powering OFF the PC-based controller. Failure to do a shutdown properly can corrupt Windows with the loss of critical files.*

18. Turn the pump power switch **OFF**.
19. Turn the air supply valve **OFF**.
20. Disconnect the breaker box that provides main power to the OMAX equipment.

Ensuring Clean and Quiet Machining

There are a number of techniques that promote clean and quiet machining with the OMAX.

Keep the Abrasivejet Nozzle Under Water

Machining under water is significantly quieter than machining with the nozzle above water. There is also less spray from the abrasivejet when under water. Keep the abrasivejet nozzle under ¼" to 2" (6 to 51 mm) of water during machining.

Note: *Raising the abrasivejet nozzle above the water once machining is finished, prevents the water and abrasive mix from being drawn into the mixing tube and plugging it.*

When working with a highly buoyant material such as wood or paper products, it may not be possible to keep the abrasivejet nozzle under water. In this situation, always wear hearing protection and be prepared for the additional over-spray during machining.

Place a Muff on the Abrasivejet Nozzle

The OMAX is shipped with a sponge muff that fits over the abrasivejet nozzle. This muff serves several purposes. It keeps the noise level low during machining, reduces splashing and spraying, and protects the Z-axis and cutting head components. Always place a muff on the abrasivejet nozzle when machining.

This muff will eventually wear out. Included with the OMAX software is a file called "Muff" in the \SAMPLES\USEFUL_TOOLS directory that contains the pattern needed for making additional muffs. Use sponge material at least 1" (2.5 cm) thick for the muff. Muffs may also be ordered from OMAX.



Figure 4-33: Cutting Nozzle with a Muff Attached

Keep Extra Sponges on Hand

Extra sponges should always be available. Set the sponges in the tank around the material being machined. When the abrasivejet stream strikes one of the support slats, often the stream is deflected and water sprays. The sponges reduce the spray and are also handy for wiping down the work surface.

Washing Heavy Garnet Deposits from Parts

Garnet will be deposited on the surface a part while being machined. Because the abrasivejet nozzle moves slowly and has time to stir up more sediment, this is most noticeable when working with thick materials. When too much spent abrasive has accumulated, the abrasivejet nozzle will need to plow through it, causing the material to shift and reduce the accuracy of the cut.

If too much garnet accumulates on a part while machining, wash away the deposits with a hose while the OMAX makes the cut.

Tips for Effective Cutting

- **Use an abrasivejet nozzle standoff of between 0.040" and 0.060" (0.060" required for TAJ)**
The closer the abrasivejet nozzle is to the material being cut, the less the taper. The ideal distance from the end of the nozzle to the material (standoff) is as close as possible without actually touching. Increasing this standoff increases the taper. Lower standoff distances increase the likelihood of plugging the nozzle during piercing. You can avoid this problem by pre-piercing holes using a higher standoff.

Note: *The default standoff is set for 0.060" (1.524 mm). The software uses this value to determine how to cut a part. If a different standoff value is used, change it using "Motion Preferences" (Setup/Motion Preferences...).*

- **Keep contaminants out of the abrasive**
Contaminants in the abrasive material clog the mixing tube. Contaminants include drops of water, bits of paper, metal shavings, dirt, etc.
- **Measure the tool offset regularly**
The tool offset (half the width of the abrasivejet kerf) will gradually increase as the mixing tube in the abrasivejet nozzle wears. Frequently measuring and adjusting the tool offset helps maintain a high degree of accuracy in your parts.
- **Make sure the slats have a uniform height**
If the height of all slats is not uniform, the part can rock up and down as it is machined, affecting accuracy.
- **Avoid machining along a slat top**
To minimize excessive tank spray, try to place the material so the abrasivejet is not cutting along a slat. Cutting along a slat also shortens its life.
- **Rotate slats regularly**
Most parts are cut in the same area of the machine. Slats located in this area tend to wear out first. Rotating slat placement distributes their wear and extends their usefulness.
- **Orient the short direction of a part parallel to slats**
Try to arrange drawings so that the shortest dimension runs parallel to the slats (up and down). This keeps the finished part from slipping between the slats and to the tank bottom.
- **Be careful of parts that tilt**—the cutting nozzle could crash into them.
- **Cut parts so they're supported by as many slats as possible**
- **Position parts with the longest dimension perpendicular to the slats**
This minimizes the risk of tilting.
- **Be wary of parts with heavy ends that may tilt even when supported by many slats**
- **Reposition weights during a traverse.**
Wait until the OMAX reaches a rapid traverse (green line on tool path) before you stop machining and reposition weights. This is easily done by right-clicking on the "pause" button in **Make** and choosing "Pause at Start of next traverse," or "Pause at end of next traverse."

- **Don't precut material**
Big sheets of material are easier to clamp into place and weight down. Small pieces of material can be difficult to weight properly; there may not be enough room for both the part and the weights.
- **Sandwich sensitive material between sacrificial material**
When cutting parts that are sensitive to scratching, sandwich the part between pieces of a sacrificial material. The bottom of the part being machined is especially vulnerable to slat splash-back and frosting.
- **Put sacrificial material on material that may delaminate**
Cover the top of material that may delaminate during piercing with sacrificial material. This ensures the abrasive is completely flowing before it reaches the good material.
- **Start at the edge of materials that can't be pierced**
Some materials cannot be easily pierced. For example, weak granites can be pierced, but may chip or crack apart. When cutting these material types, cuts must be started from an edge of the material. Other materials, such as glass, can be pierced using low pressure.
- **Avoid material with deep scratches**
For the best possible surface finish, use stock that does not have deep scratches on the surface. Scratches on the surface can deflect the abrasivejet stream and cause irregularities on the bottom of the part.
- **Draw parts to start in a consistent position**
Always design parts so that the starting position is in the same place (such as the upper left-hand corner). This allows consistent positioning of the abrasivejet nozzle when making parts.
- **Don't always make parts in the same location**
Using the identical location wears out slats in the area more quickly and can cut through the tank. Make your parts in different areas of the table to even slat wear.
- **Place a rod inside tubing when cutting**
When cutting hollow tubing or pipe, place a solid rod inside the tube. In a hollow tube, the abrasivejet stream spreads out when it strikes the air inside the tube, causing the far end of the cut to be wider with a ragged edge.
- **The top surface may be used for tooling**
The top surface of the OMAX frame is flat and is exactly parallel to the X and Y motion of the abrasivejet nozzle. This surface may be used for any special fixturing installed.

Note: For additional tips on effective cutting, consult the OMAX Interactive Reference where an entire section is devoted to tips.

Startup Checkoff Sheet

Use the following checkoff sheet to ensure that all equipment startup tasks are completed and in the required sequence. For more detailed startup instructions, refer to Cut Your Parts, page 4-11.

WARNING! *Safety First – Always wear safety glasses, ear protection, and hand protection when operating your OMAX JetMachining Center.*

1. **Main breaker box POWERED ON.**
2. **Air supply valve OPENED.**
3. **Water supply valve OPENED.** Verify white tank water level.
4. **High-pressure pump POWERED ON.** Verify that pump LED screen becomes active.
5. **Charge Pump POWERED ON.** Verify cooling flow from 3 white tank hoses.
6. **PC-based controller POWERED ON.**
7. **Bulk feed hopper PRESSURIZED** (if applicable).
8. **OMAX Make STARTED.**
9. **Table AUTO HOMED** to ensure that absolute home position is correct.
10. **Nozzle POSITIONED** between slats, 1 to 2" (2.54 - 5.1 cm) above the water level.
11. **Nozzle low-pressure water test STARTED.** Click "Test", "Low", and "Water".
12. **Straight and narrow jet stream VERIFIED** while pinching the abrasive feed tube.
13. **RPM and Pressure ADJUSTED and RECORDED** from the pump LCD screen.
14. **Nozzle low-pressure test STOPPED.**
15. **Nozzle high-pressure test STARTED.** Click "Test", "High", and "Water".
16. **Straight and narrow jet stream VERIFIED** while pinching the abrasive feed tube.
17. **RPM and Pressure ADJUSTED and RECORDED** from the pump LCD screen.
18. **Charge pressure at full flow RECORDED.**
19. **Nozzle high-pressure test STOPPED.**
20. **Water and Abrasive test STARTED.** Click "Test", "High", and "Water & Abrasive".
21. **Increased sound level and stream diameter CONFIRMED.**
22. **Abrasive flow rate MEASURED.**
23. **Adjustable Dump Orifice pressure adjusted** to match nozzle high-pressure.
24. **Setup and Pump Nozzle settings VERIFIED** correct.
25. **High- and low-pressure values SET** to match pump settings above.
26. **"Event & Relay Timing" settings VERIFIED** correct.
27. **Verify Cutting Model Optimization setting are correct.**

You are now ready to begin machining.

Shutdown Checkoff Sheet

Use the following checkoff sheet to ensure that all equipment shutdown tasks are completed and in the required sequence. For more detailed shutdown instructions, refer to Shutting Down the JetMachining Center, page 4-19.

WARNING! *Safety First – Always wear safety glasses, ear protection, and hand protection when operating your OMAX JetMachining Center.*

1. **Nozzle POSITIONED between slats, 1 to 1.5" (2.54 - 3.8 cm) above the water level.**
2. **Nozzle high-pressure test STARTED.** Click "Test", "High", and "Water".
3. **Pump RUN for 20 seconds** to clean and clear all abrasives, then test stopped.
4. **Water LOWERED** to lowest level.
5. **Nozzle POSITIONED** at desired location for shut down.
6. **USB/other media REMOVED** from PC.
7. **OMAX Make CLOSED.**
8. **Windows "Shut Down" CLICKED.**
9. **PC-based controller POWERED OFF.**
10. **PC shutdown VERIFIED** (no PC lights; black monitor screen).
11. **Bulk feed hopper DEPRESSURIZED** (if applicable).
12. **Charge pump POWERED OFF.**
13. **High-pressure pump POWERED OFF.**
14. **Water supply valve CLOSED.**
15. **PC-based controller POWERED OFF.**
16. **Air supply valve CLOSED.**
17. **Main breaker box POWERED OFF.**

Your OMAX equipment is now properly shutdown.

OMAX Pump Maintenance

This section describes how to rebuild the high-pressure wet end of the OMAX pump. It is strongly recommended that the OMAX pump be serviced at regular intervals according to the maintenance schedules documented in chapter 5, OMAX Pump Maintenance. It is important to inspect various parts for wear or damage and to replace worn or damaged parts to promote the longest life possible with each build of the high-pressure pump. It is also recommended that the procedures be followed in the order given each time the pump is rebuilt.

WARNING! *All electrical and maintenance work described in this chapter should be undertaken only by qualified service personnel. The Safety instructions presented in the first chapter of this manual must be followed.*

Consumable Pump Parts

The table below identifies the consumable parts/accessories for OMAX pumps that wear out or otherwise need replacement on a predictable basis as part of normal system operation. For assistance in ordering consumable parts, contact OMAX Technical Support.

Description	P/N
Fuse, Time Delay, 250 VAC, .5 A, 5mm x 20mm, Glass	201704
20" Cartridge, Coarse, Wall Pre-filter	204814
20" Cartridge, Fine, Wall Pre-filter	204815
200 Mesh Strainer, Charge Pump Tank, Reservoir	203690
10" Cartridge, Coarse, Charge Pump Pre-filter	202533
10" Cartridge, Fine, Charge Pump Pre-filter	202532
Air Filter, Fluted, package of 5	203739

Maintenance Schedules

The following maintenance activities and schedules are provided to aid in the development of a successful pump maintenance program.

Note: *The hours listed in this chapter for recommended pump maintenance scheduling are NOT warranty hours. Please refer to the OMAX Two Year Limited Warranty on page 9-4 for warranty information*

General Maintenance

Recommended Hours	Power-end Maintenance Performed
50	Change oil, check belt tension
Every 300	Change oil, check belt tension
Variable	Clean white water tank, remove debris from screen
Variable	Change water filters whenever the difference in pressure between the inlet and outlet gauges is equal to, or larger than 20 psi.

Recommended Hours	Power-end Maintenance Performed
Variable	Replace electrical-enclosure air filters approximately once per month, or more frequently if required.
6 Months	Lubricate the main electric motor bearings: refer to Lubricating the Electric Motor, page 5-38, for grease specifications.

High-pressure Wet End Maintenance

Routine Maintenance Schedule

Wet End Maintenance	Recommended Hours	
	P3050	3055V/ P4055V
Install Minor Maintenance Kit (P/N 302700)	500	-
Install Major Maintenance Kit (P/N 302701)	1000	500
Install Minor Maintenance Kit (P/N 302700)	1500	-
Install Major Maintenance Kit (P/N 302701)	-	1000
Install Minor Maintenance Kit (P/N 302700)	-	-
Install Major Maintenance Kit (P/N 302701)	-	1500
Install Overhaul Kit (P/N 305098)	2000	2000

Note: Repeat the above sequence for the corresponding pump after every Overhaul Kit installation.

Less Frequent Maintenance Schedule

Wet End Maintenance	Recommended Hours	
	P3050	3055V/ P4055V
Replace Plunger Assemblies (P/N 304885)	Every 2000	Every 2000
Replace Liquid Displacers (P/N 303294)	Every 2500	Every 2500
Replace Cylinders (P/N 300737)	Every 4000	Every 3500
Replace Manifold (P/N 301350)	Every 5000	Every 4500

Minor Maintenance Detail

Task	P/N	Description
Replace	200377	O-ring
	200905	O-ring
	200909	O-ring
	202398	U-cup seal
	300726	Static seal
	300733	Static seal
	301635	Ring seal
	301639	Ring seal
	302244	Back-up ring assembly, with support ring
	302950	Seal assembly
	304104	Filter assembly, manifold
		Kit 302700
Inspect	200904	Ball
	300640	Seat, check valve
	300735	Static back-up ring
	301873	Check valve retainer, outlet
	302981	Seal, housing assembly
	303251	Body, check valve
	303252	Retainer, check valve, inlet
	303274	Ring support
303294	Displacer, liquid	

Major Maintenance Detail

Task	P/N	Description
Replace	200377	O-ring
	200904	Ball
	200905	O-ring
	200909	O-ring
	201277	Washer, flat
	202398	U-cup seal
	300640	Seat, check valve
	300726	Static seal
	300733	Static seal
	300734	Screw, soc hd cap, 4-48
	301635	Ring seal
	301639	Ring seal
	301873	Check valve retainer, outlet
	302244	Back-up ring assembly, with support ring
	302950	Seal assembly
	303274	Support ring, seal
	304104	Filter assembly, manifold
		Kit 302701

Task	P/N	Description
Inspect	300735	Static back-up ring
	302981	Housing assembly
	303251	Body, check valve
	303252	Retainer, check valve, inlet
	303274	Ring support
	303294	Displacer, liquid

Overhaul Detail

Task	P/N	Description
Replace	200377	O-ring
	200905	O-ring
	202398	U-cup seal
	300726	Static seal
	301635	Ring seal
	302244	Back-up ring assembly, with support ring
	302950	Seal assembly
	303401	Check valve assembly, internal inlet
	304104	Filter assembly, manifold
Inspect	300727	Back-up ring
	303294	Displacer, liquid

**Kit
305098**



Maintenance of the Wet End Pump Assembly

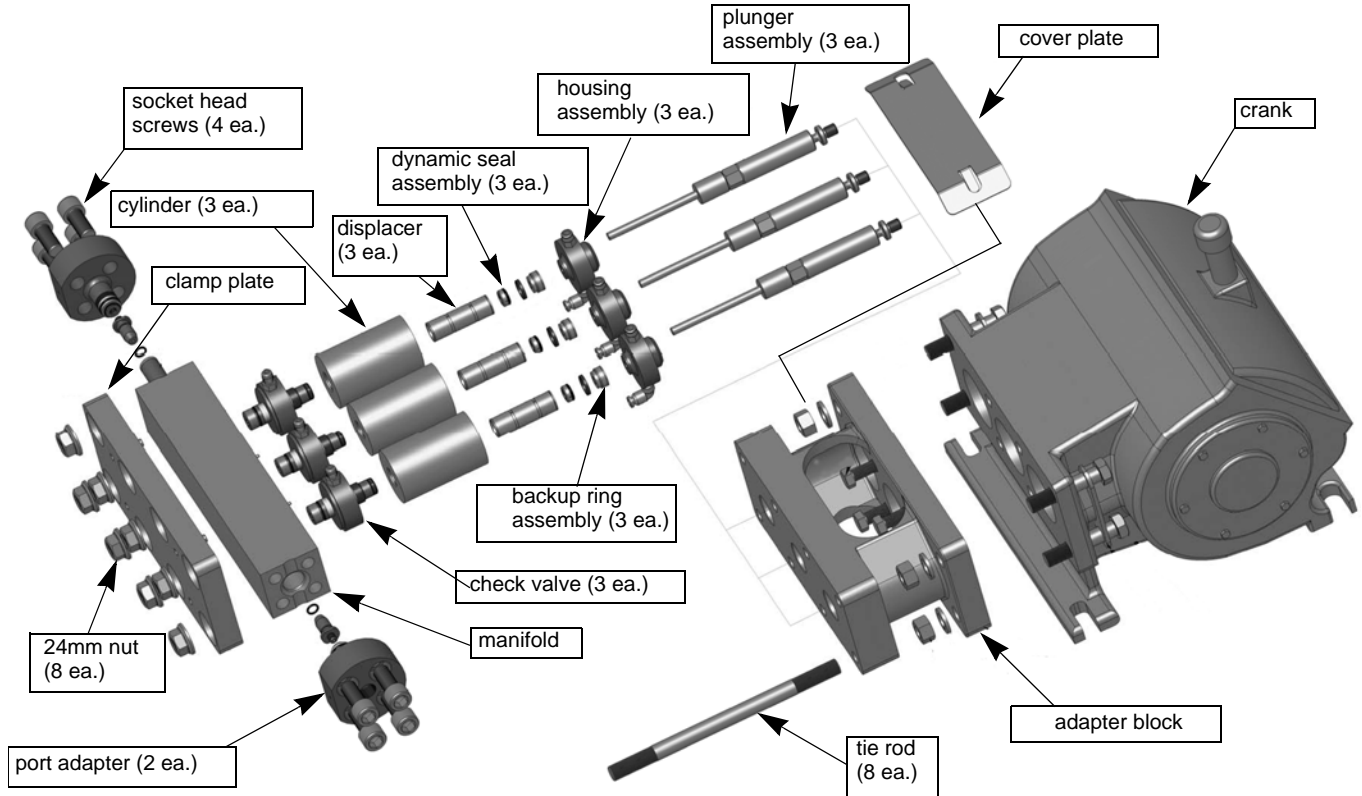

Figure 5-1: Major Components of the Wet End Pump Assembly

Tools Required for Wet End Maintenance

The following table lists all tools used in the pump and nozzle rebuild procedures for the individual components.

Tools Required	Wet End Assembly	Backup Ring	Liquid Displacers	Check Valve	Port A adapter	Coolant Housing	Plunger	Dynamic Seal	Pump Motor Belt	Electric motor lubrication	Safety Valve
Open End Wrenches											
1/4"											
1/2"	X			X							
5/8"					X						
9/16"	X										
11/16"											
3/4"									2 ea.		
13/16"	X										
1"	X										X
1-1/4"											
1-1/2"											
Crow's Foot Wrenches											
5/8"				X							
3/4", 3/8" drive							X				
1-1/8"											
Sockets											
10 mm									X		
15/16" (24 mm); 1/2" drive	X										

Tools Required	Wet End Assembly	Backup Ring	Liquid Displacers	Check Valve	Port A adapter	Coolant Housing	Plunger	Dynamic Seal	Pump Motor Belt	Electric motor lubrication	Safety Valve
14 mm Allen head socket					x						
Ratchet Wrench											
1/2"	x										
Breaker Bars											
1/2" drive	x										
3/8" drive							x				
Torque Wrench											
measures up to 175 ft-lb (237 N·m)	x				x						x
measures up to 250 in-lb (28.2 N·m)				x			x				
Allen Wrenches											
3/32"				x							
3 mm											
5 mm											
6 mm											
Pliers											
Channel lock				x							
Needle nose				x							
External snap-ring					x						
Internal snap-ring						x					
Screwdrivers											
(2) Large flat-blade	x				x						
Small flat-blade					x	x					
3/16" flat tip										x	
Lubricants											
Anti-seize lubricant P/N 202563	x			x	x		x				
Lubriplate P/N 201304	x			x	x	x		x			
Extreme Pressure Lube P/N 202496	x										
Blue Goop anti-galling compound P/N 302692	x										x
Arctic Grease P/N 304368											
LPS lubrication or WD-40											x
Special Tools											
Check valve removal tool P/N301578B	x			x							
Removal/installation tool P/N301644C	x			x							
0.124" diameter anti-rotation pin, (1/8" x 2-3/4")				x							
Spanner wrench P/N 304512											
Seal removal tool											
Inspection Tools											
Magnifying glass (or microscope)	x	x		x							
1-inch (2.54 cm) micrometer			x								
Other											
3 ft. straight edge									x		
Arbor Press	x							x			
Soft-jawed Vise				x	x						
Soft-blow mallet	x				x						
Propane torch				x							
Grease gun										x	
Scale for weighing abrasive flow								x			
Ultrasonic cleaner								x			



Removing the High-pressure Wet End Assembly

The high-pressure wet end assembly consists of those pump parts which are bolted to the crankcase and are directly involved in providing high-pressure water. Refer to Figure 5-2. When disassembling this assembly, keep all parts together in related sets, noting the original position of each set.

Refer to "Tools Required for Wet End Maintenance" on page 5-6 for a list of tools used in maintenance of the pump's wet end assembly.

Caution: *Never use a pipe wrench on any OMAX equipment!
Do not disassemble the pump wet end unless a torque wrench capable of 175 ft-lb (235 N-m) is available for reassembly.*

To remove the high-pressure wet end assembly:

1. Turn power to the Pump OFF at the main AC disconnect. Place a "lock-out tag" on the power disconnect to alert others that maintenance is in progress.
2. Disconnect the Hard Plumbing from the Port Adapter, using the 13/16" and a 1" open end wrench. See Figure 5-2:

WARNING! *Before disconnecting the hard plumbing, ensure that the pump has been shut down, allowing the system to depressurize.*



Figure 5-2: High-pressure Wet End Assembly

3. Remove the three Water Hoses from the Check Valve Inlets using the 9/16" open-end wrench. Hold the fitting with the 1/2" open-end wrench to avoid unscrewing it from the Check Valve Body.
4. Using the 24 mm socket (or 15/16" socket) and 1/2" breaker bar, remove the eight 24 mm Nuts from the Clamp Plate (Figure 5-2), being careful to remove the load on the Tie Rods evenly. Break loose the Nuts at the ends of the Clamp Plate first, then use a crisscross pattern when breaking the remaining four Nuts loose (Figure 5-3). Using the same pattern, back each Nut off 1/2 turn until the load is removed from the Tie Rods.

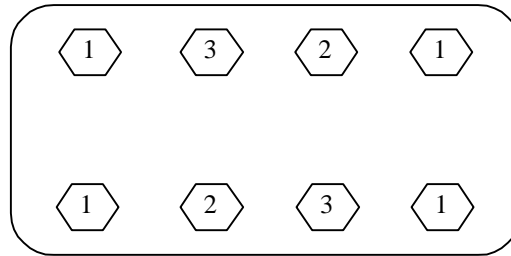

Figure 5-3: Nut Loosening Sequence for Removing Clamp Plate from High Pressure Assembly.

5. Remove the clamp plate and set it aside:

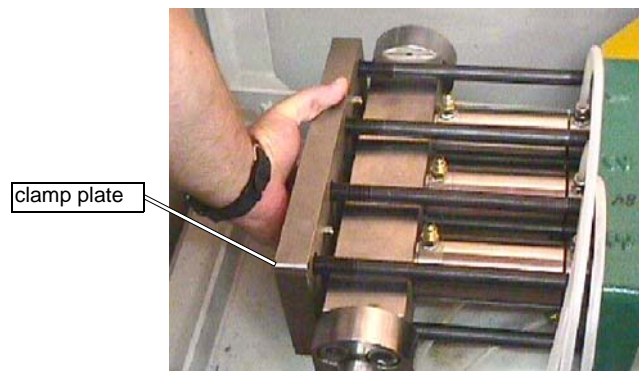

Figure 5-4: Clamp Plate Removal

6. Slide the Wet End Assembly away from the Coolant Housings. See Figure 5-5. Keep the assembly level and square, being careful not to bind the internal Plungers. All components typically stay in the Cylinders as the Wet End Assembly is removed.

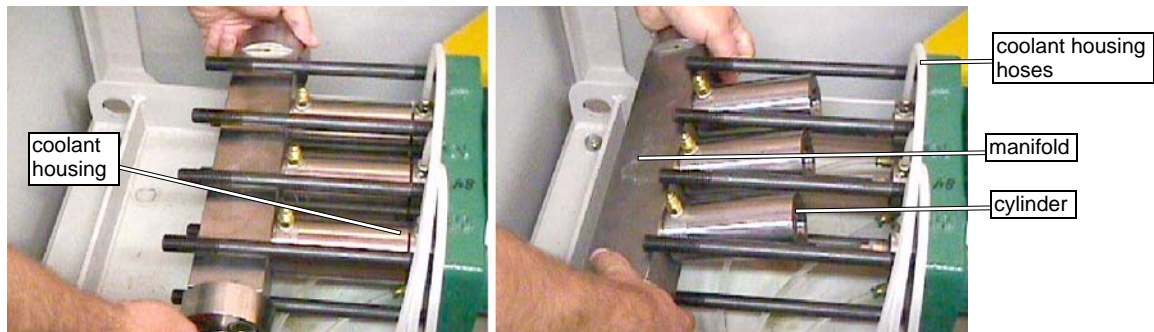

Figure 5-5: Removing the Wet End Assembly

7. When a Coolant Housings sticks to the Wet End Assembly, stop and disconnect the Hoses, top and bottom, from each Coolant Housing. Proceed as in step 6, above.

Note: *If a coolant housing sticks to the cylinder and cannot be removed by hand, disconnect the coolant hoses and allow the coolant housing to remain attached to the cylinder.*

8. Set the Wet End Assembly on a workbench with the Manifold down and the Cylinders standing upright.

Caution: *If one cylinder has problems and the wet end assembly has been removed, all three cylinders must be removed and rebuilt using these procedures for disassembling and reassembling the*

high-pressure wet end. If the wet end was fully assembled, torque applied and then removed, the ring seals are not reusable and must always be replaced.

Disassembling the Wet End Assembly

The following OMAX disassembly tools are available to aid in the assembly and disassembly of the wet end assembly's high-pressure seal components:

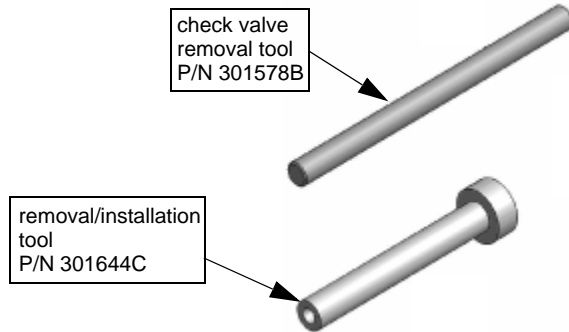

Figure 5-6: OMAX Special Disassembly Tools

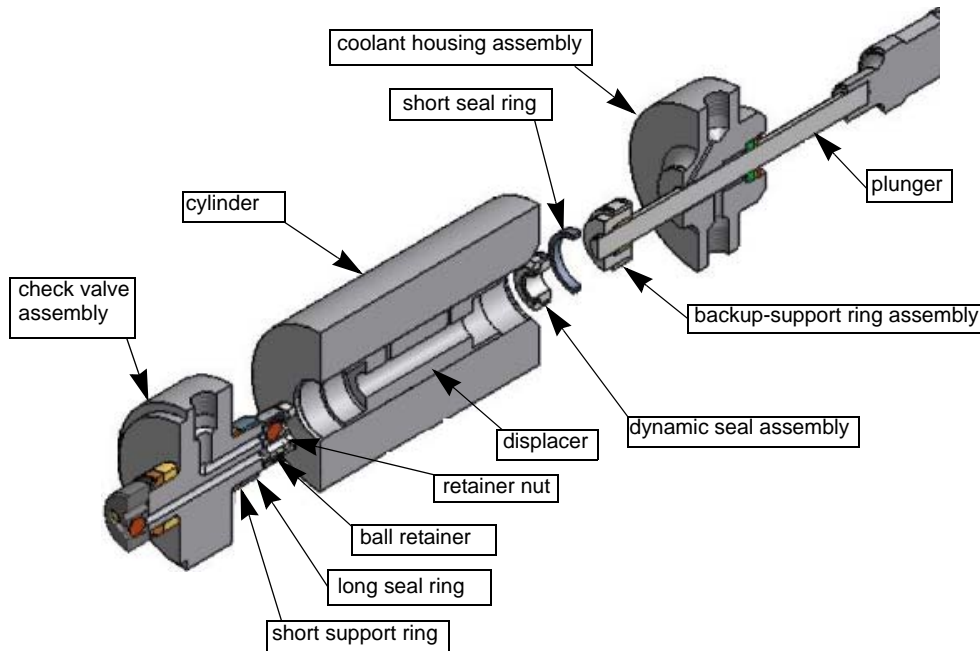

Figure 5-7: High-pressure Wet End Assembly Components

Note: Remember to maintain all removed parts in related sets, noting the original position of each set.

To disassemble the high-pressure wet end assembly:

1. Remove the Cylinders (3 ea.) and the Check Valve Assemblies (3 ea.) from the Manifold using two large flat-blade screwdrivers to lift the Check Valve Assembly and Cylinders out of the pressure Manifold:



Figure 5-8: Removing the Cylinder and Check Valve Assembly

Note: If the coolant housing assemblies remained fixed to the cylinders when removing the wet end assembly, clamp the outside diameter of the coolant housing into the soft jaws of a vise and strike the side of the cylinder with a soft blow mallet to remove the coolant housings from the cylinders. The close tolerance fit of the coolant housing into the cylinder bore extends only into the bore of the cylinder approximately 0.050" and should remove easily.

2. Insert the Check Valve Removal Tool (Figure 5-9) through the Backup-support Ring Assembly (Figure 5-7) of the first Cylinder until it contacts the check valve Retainer Nut inside the Cylinder.

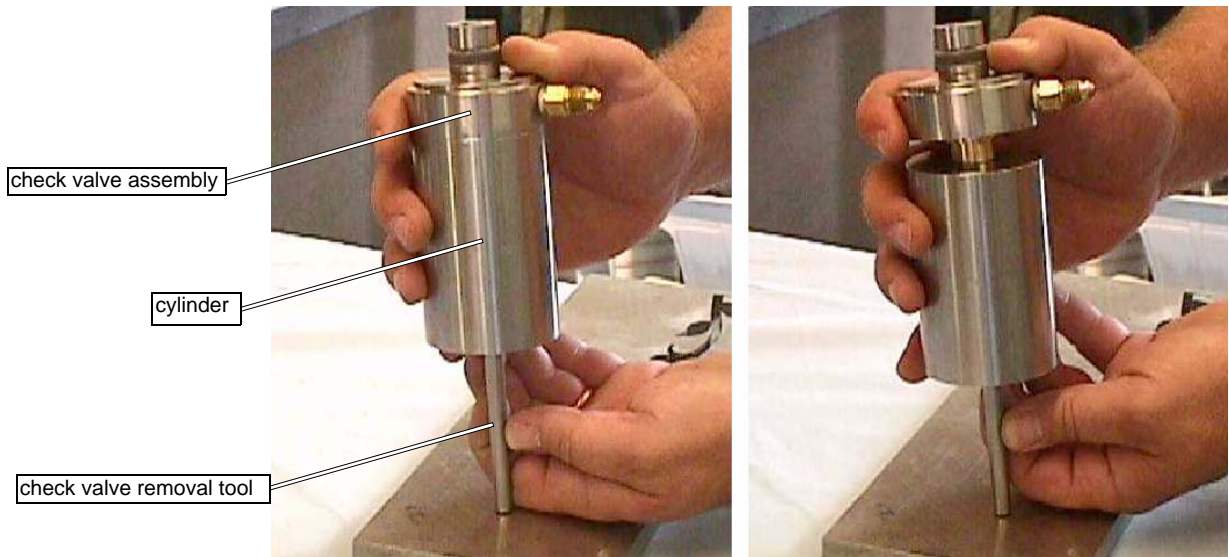

Figure 5-9: Using the Check Valve Assembly Removal Tool

3. Strike the tool firmly against a solid surface to remove the Check Valve Assembly from the Cylinder Assembly. Set the Check Valve Assembly aside until later. Repeat for the remaining two cylinders.
4. Using the Removal/installation Tool (Figure 5-6), push the Sealing Assembly (Displacer, Retainer and Seal Assembly, Short Seal Ring, and Backup-support Ring Assembly - Figure 3-10) out of the Cylinder from the Check Valve Assembly end toward the Coolant Housing Assembly end using an Arbor press (Figure 5-11). Repeat for the remaining two cylinders.

Note: The long seal ring on the inlet side of the check valve assembly usually remains in the cylinder bore and can be easily removed by hand.

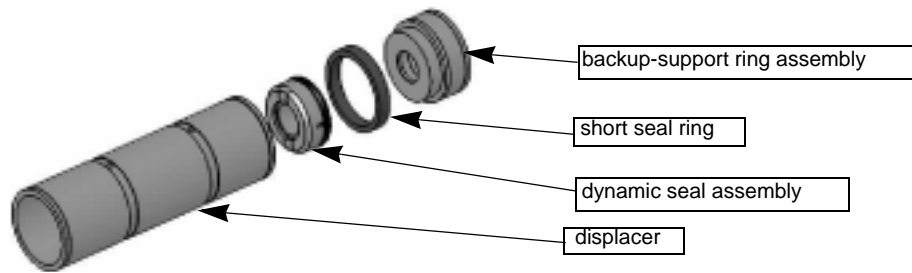

Figure 5-10: Sealing Assembly Components

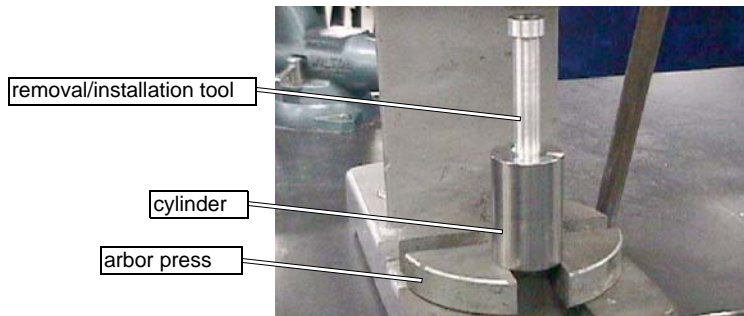

Figure 5-11: Removing the Sealing Assembly using an Arbor Press

5. Separate the Backup-support Ring Assembly (Figure 3-10) from the Displacer by placing the large end of the Removal/installation Tool (Figure 5-12) over the Backup-support Ring Assembly and breaking the Short Seal Ring loose from the Displacer.

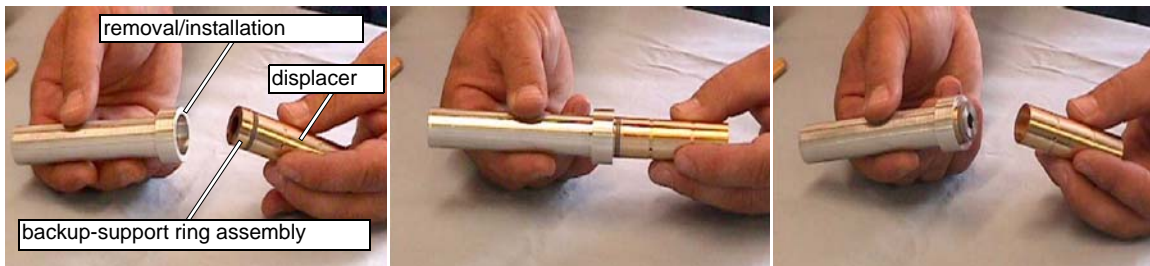

Figure 5-12: Separating the Backup-Support Ring Assembly from the Displacer.

6. The Backup-support Ring Assembly (Figure 5-15) is machined together as one assembly. The outer Support Ring is pressed onto the inner Backup Ring. These parts should not be separated. The Short Seal Ring (Figure 5-10) should be easily removed by hand. Remove the Short Seal Ring from all three Backup Ring Assemblies.
7. Before removing the Dynamic Seal Assembly (Figure 5-10) from the displacer, inspect the Dynamic Seal for extrusion (Figure 5-13). Extrusion of seal material around the edges of the bore in the dynamic seal is to be expected. Uneven, excessive extrusion and/or missing material from one side across the face of the Dynamic Seal indicates a failed seal with possible plunger damage caused by the plunger rubbing on the bore of the backup ring. If uneven or excessive material is extruded or missing, then a close inspection of the Backup-support Ring Assembly should be made for signs of rubbing.

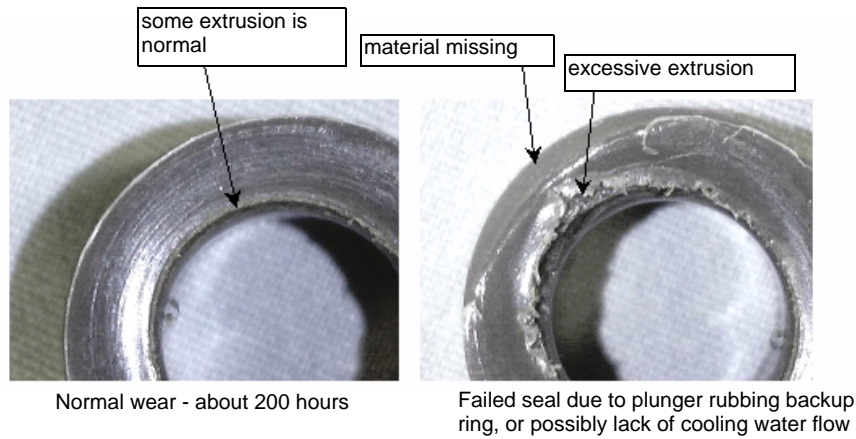

Figure 5-13: Dynamic Seal Inspection

- Remove the Dynamic Seal Assembly from inside the end of the Displacer. Remove the Large O-ring from the outside of the Dynamic Seal. Separate the components of the Dynamic Seal Assembly by pushing the Dynamic Seal out of the Retainer. Remove the Small O-ring from inside the Retainer.

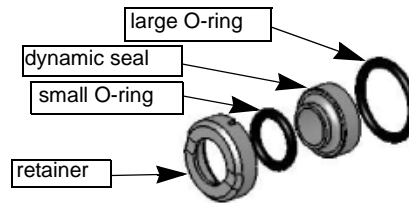

Figure 5-14: Dynamic Seal Assembly Components

- Repeat steps 4-8 for the remaining two Backup Ring and Displacer Assemblies.
- Since they are not reusable, discard the O-rings, the plastic ring seals, and the plastic Dynamic Seal of the Dynamic Seal Assembly. The metal Retainer is reusable.

Inspecting the Backup-Support Ring Assembly

If uneven dynamic seal extrusion or a dynamic seal failure occurred, the backup-support ring should be examined in detail to determine if plunger rubbing has occurred and if the associated plunger assembly needs to be replaced.

To inspect the backup-support ring assembly:

- With the magnifying glass, examine the edges and interior of the metal lip in the bore of the Backup-support Ring (Figure 5-16) adjacent to where the Dynamic Seal was positioned, especially if uneven or excessive extrusion of the Dynamic Seal was observed. The exterior edge of the short lip should be sharp and square with no nicks or gouges. There should be no evidence of rubbing on the lip.

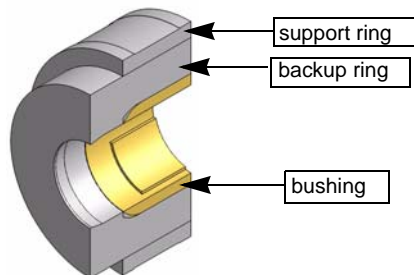

Figure 5-15: Backup-support Ring Assembly Components

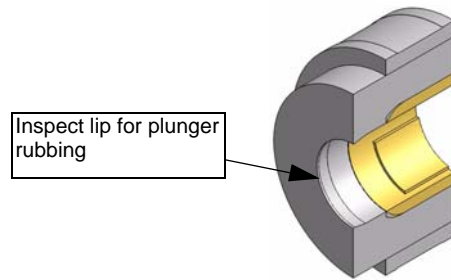

Figure 5-16: Backup-support Ring Inspection

2. Refer to the below illustration that shows both an undamaged and a severely damaged Backup-support Ring. The short lip should appear to be uniform in width all the way around. Any area where the width appears to be wider, or darker, or where the machining marks are scraped away, indicates where the lip has been rubbed by the plunger.

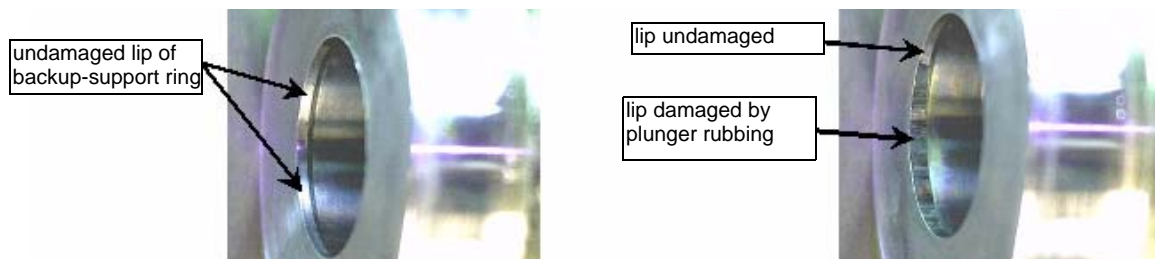

Figure 5-17: Example of Lip Damage to Backup-support Ring

Note: Whenever plunger rubbing has occurred, the plunger assembly must be replaced along with the dynamic seal and backup-support ring assembly.

Inspecting the Liquid Displacers

The small flanges on each end of the liquid displacer should be 0.8115" to 0.8125" (20.61 to 20.64 mm) in diameter. If these diameters are undersized, leakage between the coolant housing and the cylinder could result.

To inspect the liquid displacers:

1. Clean the Liquid Displacers (Figure 5-18) and use the micrometer to measure the outside diameters of each Displacer end.
2. Any Displacer that measures less than 0.8115" (20.61 mm) in diameter on either end should be replaced.
3. Inspect the displacer edges on the ends to determine if the edges are sharp, free of any missing material, nicks, gouges, or burrs. Score marks from the cylinder bore are normal.

Caution: Do not attempt to smooth score marks by sanding, as this makes the diameter undersized.

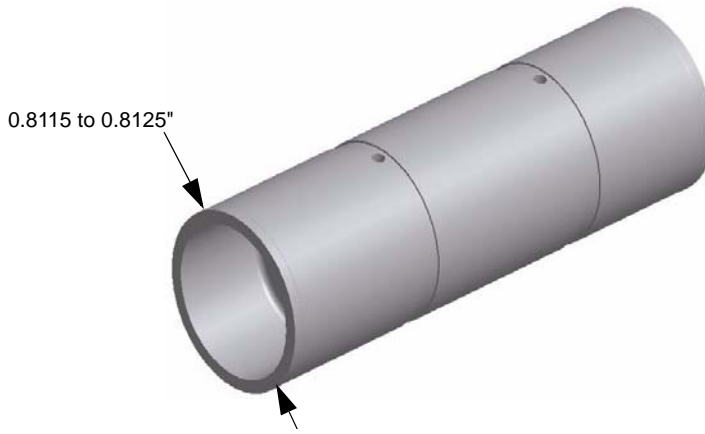

Figure 5-18: Liquid Displacer Measurements

Disassembling and Inspecting the Check Valve Assembly

The following explains how to inspect the check valve components in a check valve assembly and replace the valve seats.

It is important to inspect the seats and mating surface of the check valve body. Worn or damaged seats must be replaced. Inspection is best performed with the aid of a magnifying glass. Water leaking past check valves can form jets that damage the check valve body.

Caution: *Do not run the OMAX pump if the output pressure begins to drop by more than 4-6 KSI from the original RPM. If the check valve seats are worn, continued pump operation can damage the check valve body.*

Note: *Replacing the check valve seats in all three cylinders at the same time is a good practice. Once one check valve seat has worn to the point of replacement, the others are quick to follow. To reduce overall downtime, replace the high-pressure seals and the check valve seats whenever the wet end has been disassembled.*

Refer to “Tools Required for Wet End Maintenance” on page 5-6 for a list of tools used in maintenance of the pump’s check valve assembly.

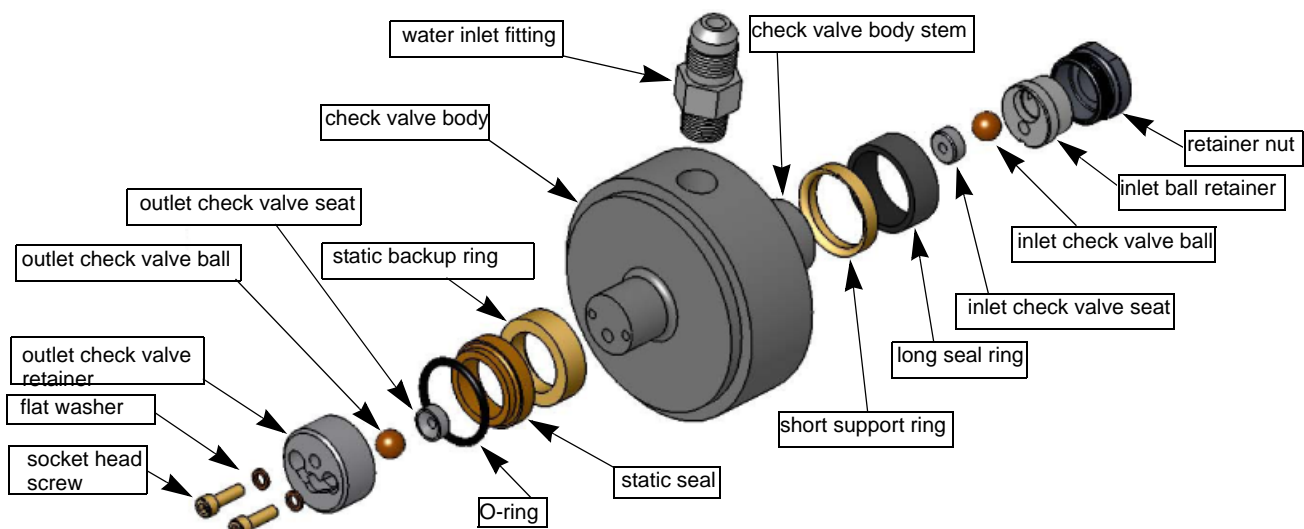

Figure 5-19: Check Valve Assembly Components

To disassemble and inspect the check valve assembly:

1. Begin disassembly of a Check Valve Assembly from the inlet (Cylinder) side. Clamp the Check Valve Body into the soft-jaws of a vise and, using the 5/8" crows foot, remove the Retainer Nut (Figure 5-20).

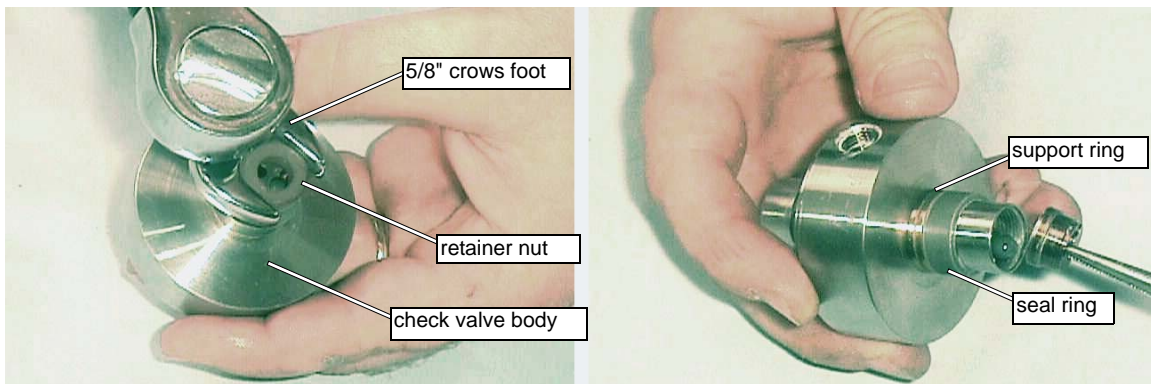

Figure 5-20: Removing the Retainer Nut from the Check Valve Body

2. Referring to Figure 5-19, remove the Inlet Ball Retainer, the Inlet Check Valve Ball, and the Check Valve Seat. A pair of needle nose pliers can be helpful when removing the Inlet Ball Retainer.
3. If the Seal Ring did not remain in the end of the Cylinder (Figure 5-1), remove it from the Check Valve Body Stem and discard it.
4. Inspect the Support Ring for cracks, chips or damage, particularly in the area around the center where it contacts the edge of the Cylinder. If no damage is found, there is no need to remove it, except at the recommended rebuild intervals. Minor scoring marks are permitted.

Caution: *Never attempt to remove scoring marks by sanding.*

5. If the Support Ring does not pass inspection or has reached its recommended replacement time, proceed to step #6.
6. A small amount of the Short Seal Ring may have extruded under the Short Support Ring, locking it to the Check Valve Body Stem. To remove the Short Support Ring from the Check Valve Body Stem, use a propane torch to heat it slightly (20-30 seconds). This softens the plastic between the Check Valve Body Stem and the Short Support Ring, allowing it to be removed by hand using a rag or a pair of channel lock pliers.

Caution: *Once the short support ring has been heated, do not reuse it; the material softens and can no longer support the ring seal compression. Take care not to scratch the check valve body stem surface with pliers during this process.*



Figure 5-21: Using a Propane Torch to Remove the Support Ring

7. Inspect the outer diameter of the Check Valve Body Stem for indications of erosion.

8. Inspect for erosion on the surface that was against the Inlet Check Valve Seat. This may indicate leakage between the flat side of the Inlet Check Valve Seat and the Check Valve Body Stem, or leakage between the Inlet Check Valve Ball and Inlet Check Valve Seat.
9. Using the magnifying glass, inspect the Inlet Check Valve Ball for pitting or chipping. If pits, chips, or frosted spots are observed on the Ball surface, replace it.
10. Inspect the Inlet Check Valve Seat for erosion across the Inlet Check Valve Ball and on the flat sealing surface that contacts the Check Valve Body Stem. If erosion or damage is observed, replace the seats.

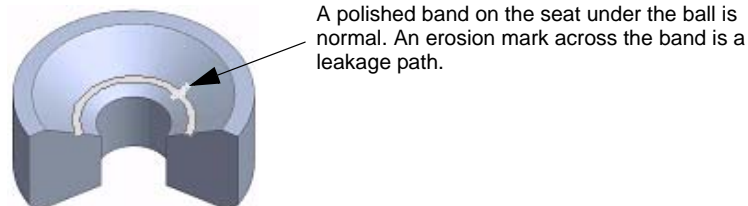

Figure 5-22: Inspecting the Check Valve Seat for Erosion Marks

11. Turn the Check Valve Body over and remove the Socket Head Screws using the 3/32" Allen wrench. Also remove the Flat Washers and the Outlet Check Valve Retainer. The socket head screws and washers should be replaced according to the maintenance schedule.
12. Perform the same inspection of the Outlet Check Valve Ball and Outlet Check Valve Seat (See steps 7-11 above).
13. Carefully inspect the Check Valve Body Stem for indications of erosion on the surface contacting the Outlet Check Valve Seat. This may indicate leakage between the flat side of the Outlet Check Valve Seat and the Check Valve Body Stem, or leakage between the Outlet Check Valve Ball and Outlet Check Valve Seat.
14. Remove and discard the O-ring and Static Seal. Inspect the Static Backup Ring, ensuring that the edges are sharp and square with no nicks or gouges. Also, see if it is cracked near the notch and replace it whenever damage is apparent.
15. Clean the Check Valve Body Stem and the radius at its base.
16. If leaking was observed between either the Check Valve Body or the Manifold and Cylinder (Figure 5-1), check the radius at the base of the Check Valve Body Stems for fine cracks using the magnifying glass.

Note: Be careful not to confuse lines of discoloration with actual cracks.

17. If a pressure loss occurred without any external leakage, but the high-pressure cylinder runs very hot, the Check Valve Body is cracked internally, requiring replacement.
18. Always discard any damaged or eroded parts and replace them with new ones.
19. Repeat this procedure for the two remaining Check Valve Assemblies.

Reassembling the Check Valve Assembly

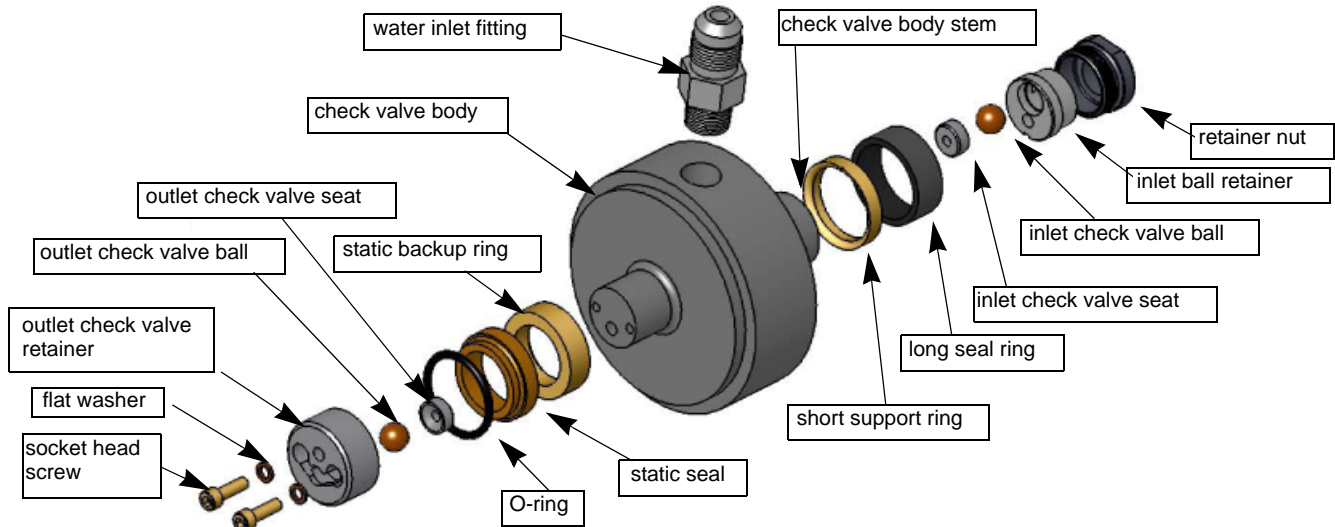

Figure 5-23: Check Valve Assembly Components

To reassemble the check valve assembly:

1. Assemble the outlet side of the Check Valve Assembly first.
2. Apply Lubriplate to the O-ring. Place the Static Backup Ring, then the Static Seal, and then the O-ring onto the outlet side of the Check Valve Body.

Note: The outlet side of the Check Valve Body has three holes in the end of the stem (Figure 5-24). The notch and chamfer on one side of the Static Backup Ring faces toward the Check Valve Body.

3. Apply anti-seize lubricant to the threads of the two Socket Head Screws. Install the Flat Washers and the two Socket Head Screws through the Outlet Check Valve Retainer (Figure 5-24):

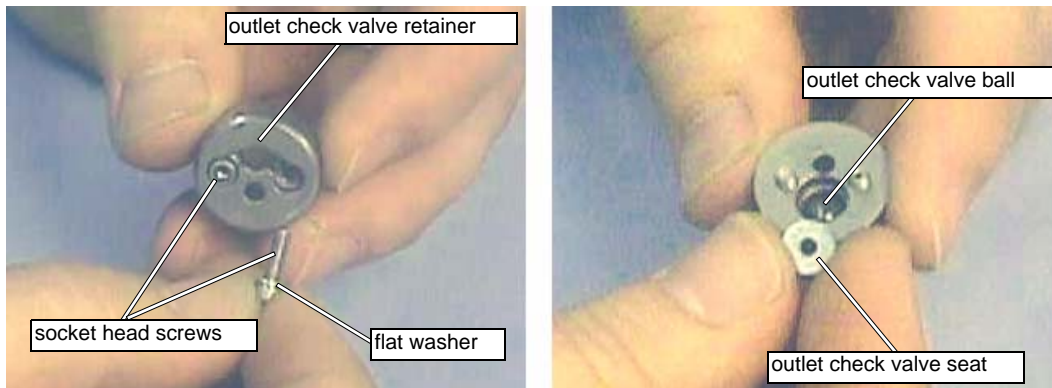

Figure 5-24: Inserting the Socket Head Screws

4. Place the Outlet Check Valve Ball followed by the Outlet Check Valve Seat in the Outlet Check Valve Retainer. Be sure that the flat side of the Outlet Check Valve Seat faces away from the ball. The Outlet Check Valve Seat should be flush, or no more than 0.001" (0.0254 mm) above, the surface of the Outlet Check Valve Retainer.
5. Place the assembled Outlet Check Valve Retainer on the outlet end of the Check Valve Body Stem with the Outlet Check Valve Seat up against the end of the stem (Figure 5-25).

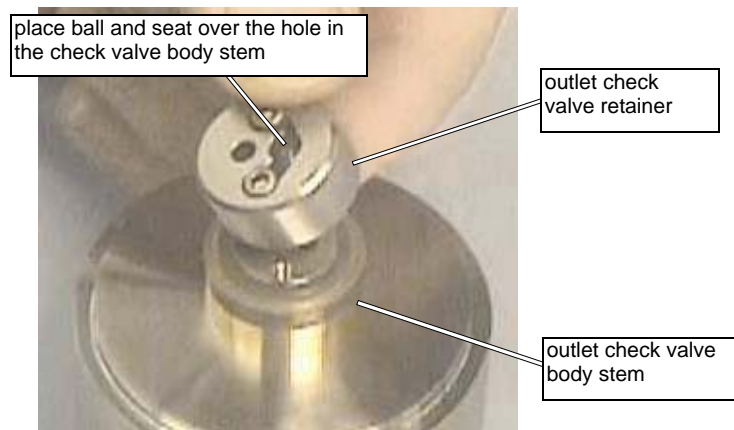

Figure 5-25: Placing the Outlet Check Valve Retainer on the Check Valve Body Stem

WARNING! Ensure that the hole through the outlet check valve seat lines up with the hole in the outlet check valve body stem. The outlet retainer can inadvertently be installed 180° out of its required position. Always ensure that the hole through the outlet check valve seat lines up with the hole in the end of the check valve body stem.

6. Using the 3/32" Allen wrench, tighten the two Socket Head Screws from 3 to 5 in-lbs (.34 to .57 N·m). Holding the Allen wrench as shown in Figure 5-26 prevents over tightening the screws.

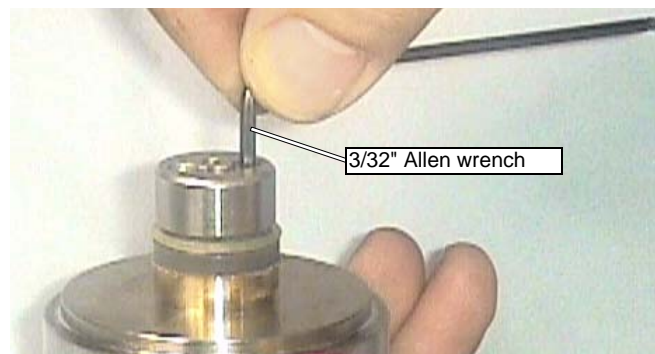

Figure 5-26: Tightening the Socket Head Screws

7. Repeat steps 1 through 6 for the remaining Check Valve Body Assemblies.
8. Next, begin assembling the inlet side of the Check Valve Body Assembly. This is the side with the threaded pocket and two holes (Figure 5-27).
9. Install the Short Support Ring, with the small notch facing down, over the outside of the Check Valve Body Stem on the inlet side.

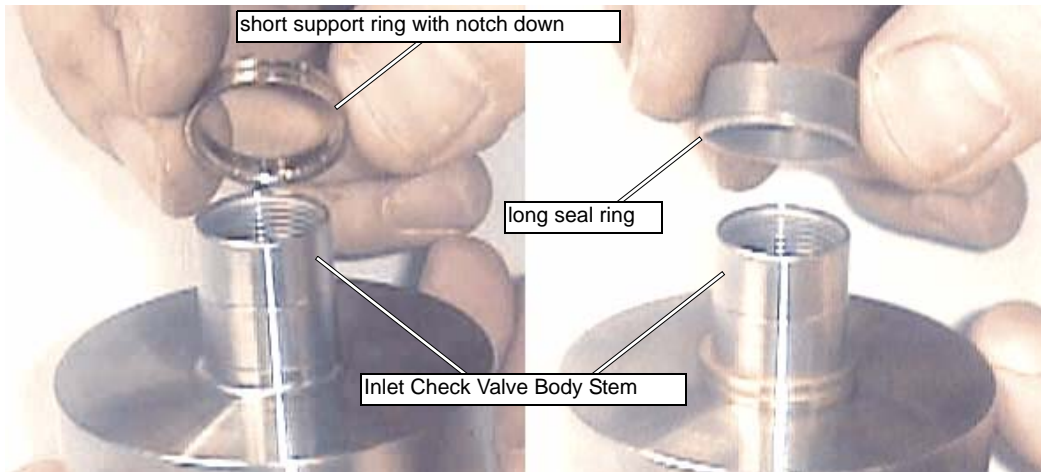

Figure 5-27: Installing the Short Support Ring

10. Install the Long Seal Ring over the outside of the Stem (Figure 5-27).
11. Next, insert the Inlet Check Valve Ball followed by the Seat into the Inlet Ball Retainer (Figure 5-28). Be sure the flat side of the Seat faces away from the ball.

Note: The inlet check valve seat normally protrudes well above the face of the ball retainer.

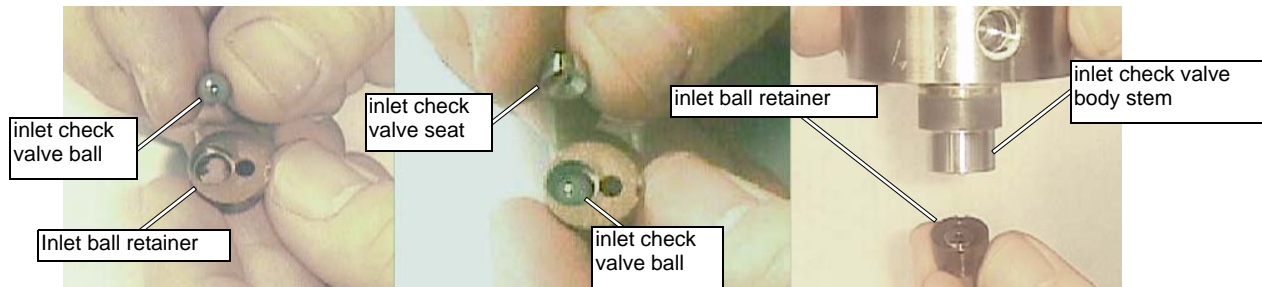

Figure 5-28: Inserting the Check Valve Ball and Check Valve Seat into the Inlet Ball Retainer

12. Hold the Check Valve Body so its stem is facing down to enable insertion of the assembled Inlet Ball Retainer (Figure 5-28).

Note: An alignment key inside the pocket of the check valve body is designed to fit into a slot machined on the outside of the retainer. Be sure to engage the alignment key into this slot. Do not turn the assembly over until the retainer is fully engaged into the slot. When correctly installed, the inlet ball retainer will be almost flush with the end of the check valve body stem.

13. Apply anti-seize compound to the threads of the Retainer Nut and to the bottom face that contacts the Inlet Ball Retainer (Figure 5-29).

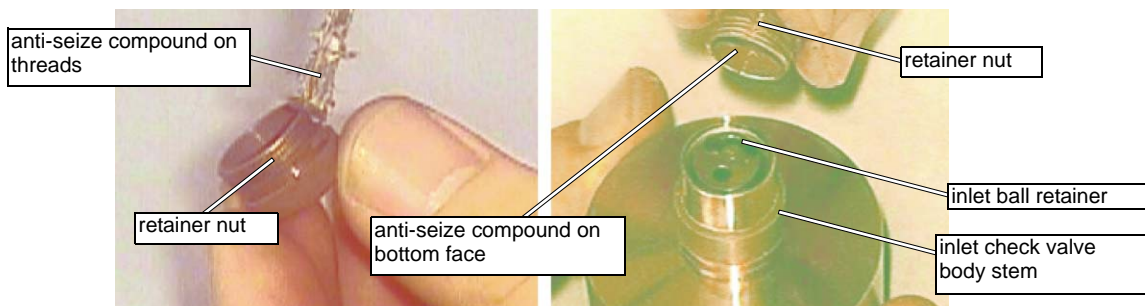

Figure 5-29: Applying Anti-seize Compound to Threads and Bottom Face of Retainer Nut

14. Screw the Retainer Nut over the Inlet Ball Retainer and into the threaded Inlet Check Valve Body Stem. Hand tighten.
15. Apply a light coat of Lubriplate to the 0.124" diameter anti-rotation pin and insert it through the outlet port of the Check Valve Retainer and into the Check Valve Body. Clamp the outside diameter of the Check Valve Body in the soft-jaws of a vise and torque the Retainer Nut to 200 in-lbs (22.6 N·m) using a 5/8" crows foot (Figure 5-30):

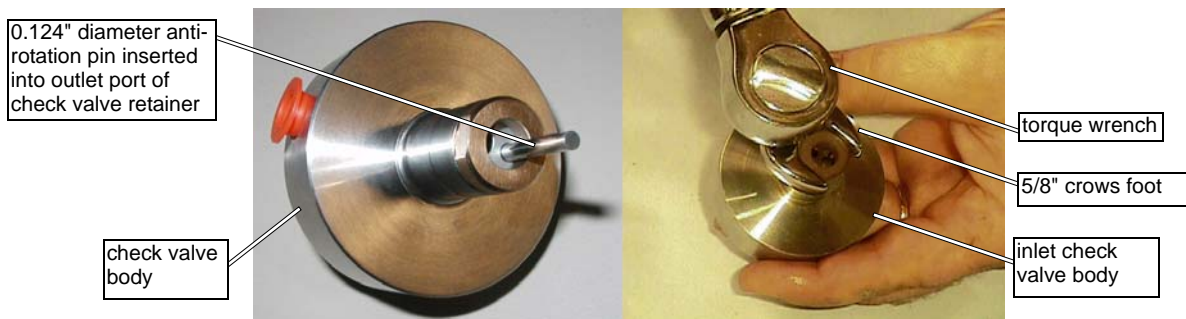

Figure 5-30: Installing the Inlet Retainer Nut

16. Remove the anti-rotation pin.

Note: This may require clamping the pin in a vise and pulling on the check valve body.

17. Repeat the above assembly procedures for the remaining two Check Valve Assemblies.

Replacing the High-pressure Port Adapter Seals and Filter

The port adapter high-pressure seals should be replaced at each pump rebuild, or at any time excessive leakage occurs between the manifold and port adapters. The pump in-line filter provides additional protection for the orifice assembly in the nozzle and dump valve. This filter should be replaced at every pump rebuild.

Refer to "Tools Required for Wet End Maintenance" on page 5-6 for a list of tools used to replace the high-pressure port adapter seals and filter.

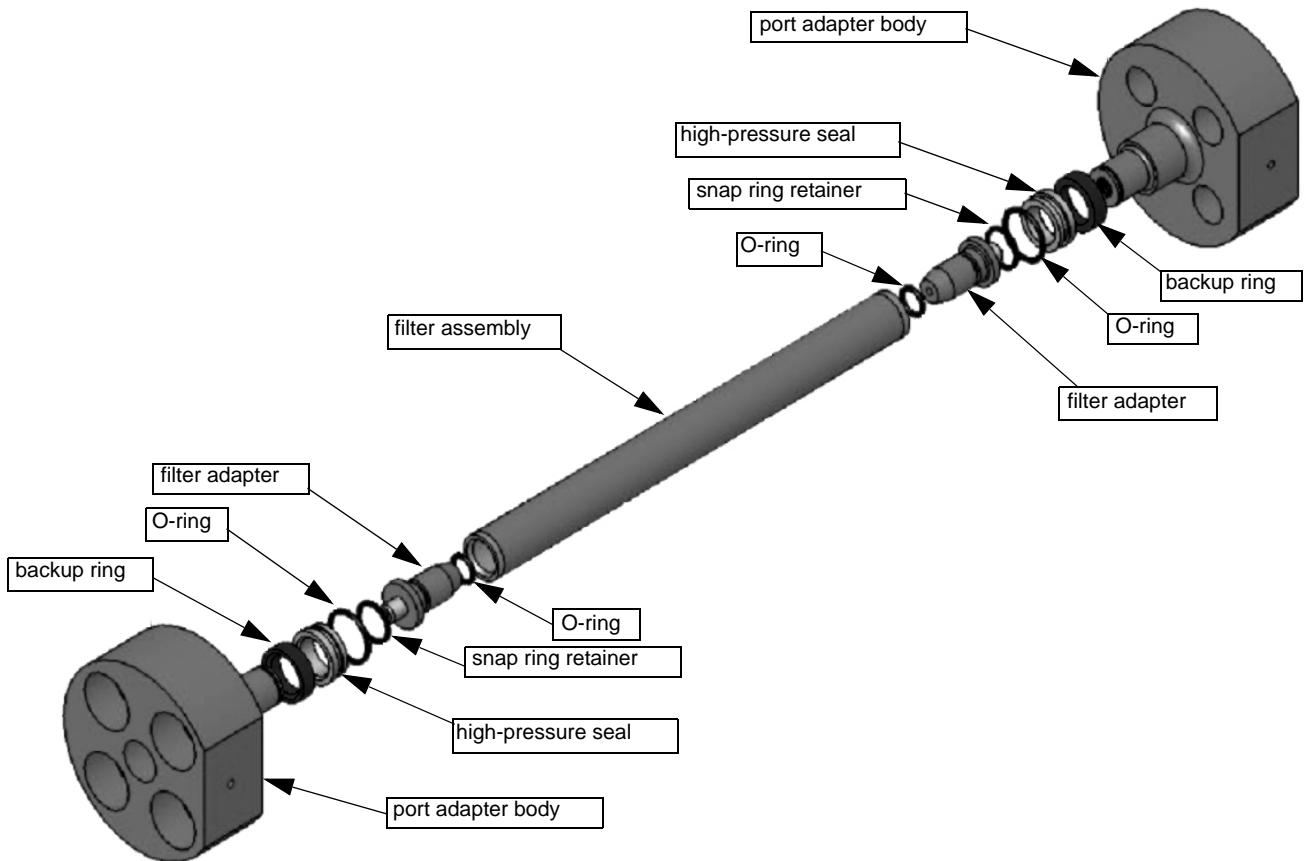

Figure 5-31: Port Adapter and Filter Assembly Components

To replace the High-pressure Port Adapter Seals and Filter

1. Place the Manifold body (Figure 5-1) into a soft-jawed vise.
2. Using the 14 mm Allen wrench, remove the four Socket Head Screws (Figure 5-1) from both Port Adapters.
3. With the soft-blow mallet, strike the Port Adapter on each side until a gap opens between the Manifold and Port Adapter.
4. With two flat-tipped screwdrivers, pry the Port Adapter out of the Manifold. Follow the same procedure to remove the second Port Adapter.

Caution: **Avoid scoring the metal components or damaging the filter.**

5. Remove the Filter Assembly. Using the 5/8" open-end wrench, remove the Filter Adapters from each Port Adapter.
6. Remove the Snap Ring Retainer from the end of the Port Adapter stem using the snap ring pliers. Slide the High-pressure Seal, O-ring, and Backup Ring off the stem of the Port Adapter Body. Discard the High-pressure Seal and O-ring.
7. Clean the Backup Ring and Port Adapter. Examine the edges of the Backup Ring to determine if the edges are square and sharp. Check the Backup Ring for cracks near the notch. Replace the backup ring whenever problems are apparent.
8. Install the Backup Ring onto the stem of the Port Adapter with the chamfer on the inside of the backup ring facing toward the Port Adapter Body.
9. Place a small amount of Lubriplate on the new O-ring and install it on a new High-pressure Seal. Slide the High-pressure Seal onto the stem of the Port Adapter Body such that the large diameter portion of the High-pressure Seal is next to the Backup Ring.

10. Install the Snap Ring Retainer.
11. Place a small amount of Lubriplate on the O-ring and install it into the O-ring groove on the Filter Adapter. Thread the Filter Adapter into the stem of the Port Adapter body. Tighten until just snug using the 5/8" open-end wrench.
12. Repeat the above rebuild procedure for the remaining Port Adapter Assembly.
13. Install the Filter Assembly on one of the Port Adapters by sliding it over the end of the Filter Adapter until the Filter Adapter rests against Filter Adapter shoulder.
14. Apply a small amount of Lubriplate into the bores on the Manifold.
15. Position the Port Adapters with its flat side of the body facing away from the direction of the Cylinders (Figure 5-1).

Note: *Either Port Adapter can be installed first. As the second one is being installed, ensure that it engages into the filter assembly properly without being forced and causing damage. Tapping the end of the port adapter lightly with a soft-blow mallet may be required to seat it completely into the manifold.*

16. Place the Manifold assembly onto a flat surface with the Check Valve (Figure 5-1) ports facing up. Apply anti-seize lubricant to the threads of the four Socket Head Screws (Figure 5-1) and tighten them sufficiently to hold the Port Adapters in place. Secure the Manifold assembly into a soft-jawed vise and torque each Socket Head Screw using the 14 mm Allen head socket to 100 ft-lb (135 N·m).

Reassembly of the Pump Wet End Assembly

Note: This section provides procedures for the complete reassembly of the pump wet end. It is very important that all parts are kept clean. In general, all the high-pressure wet end parts for the OMAX pump may be cleaned by simply wiping them with a clean lint-free rag and blowing them off with shop air. Remember, any dirt left in the pump can pass through the nozzle, possibly damaging it. Clean all parts and assemble the pump components in a clean environment.

Whenever the pump wet end of the pump has been disassembled:

- Prior to starting the pump, always remove the nozzle assembly from the plumbing to prevent debris from damaging or plugging the orifice. Run the pump for ten minutes without the nozzle to clear out any debris after reassembly.
- Always inspect all parts and replace the high-pressure seals as a set.
- Carefully wipe each part clean with a lint-free rag and blow them out with compressed air.
- Never tighten or loosen plumbing while under pressure.

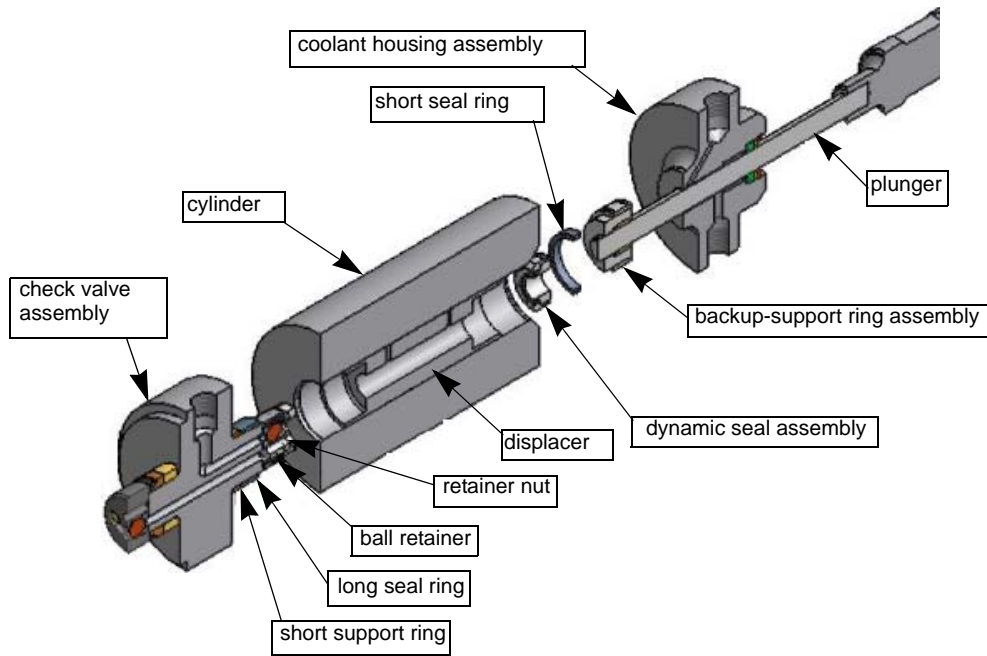

Figure 5-32: High-pressure Wet End Assembly Components

To re-assemble the high-pressure wet end assembly:

1. Apply a light coat of Lubriplate (#201304) to the interior of the holes on the pressure Manifold (Figure 5-1) and to the Check Valve Body (Figure 5-23) outlet side O-ring and Static Seal.
2. Install all three assembled Check Valve Bodies into the pressure Manifold.

Note: Because of alignment pins in the pressure manifold, check valve bodies can be installed in only one position.

3. Place the Displacer over the Inlet Check Valve Retainer (Figure 5-23) until it contacts the Long Seal Ring (Figure 5-32). Repeat this for all three Check Valve Assemblies.

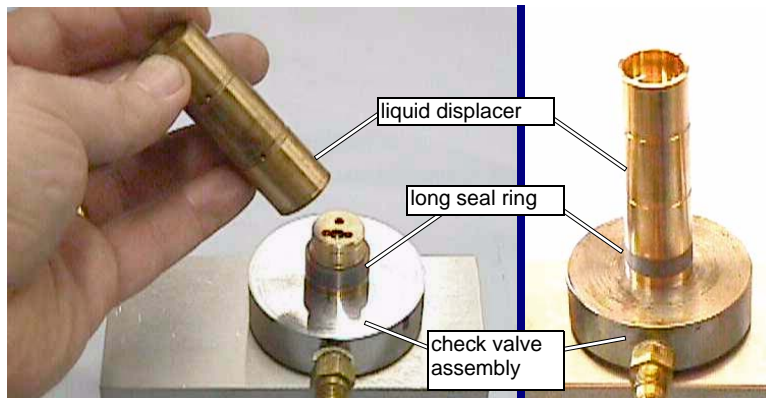

Figure 5-33: Installing the Liquid Displacer on the Check Valve Assembly

Caution: If the wrong end of the liquid displacer is installed on the check valve assembly, a large gap appears between the displacer and the seal ring. See Figure 5-34. The end of the displacer must make contact with the seal ring.

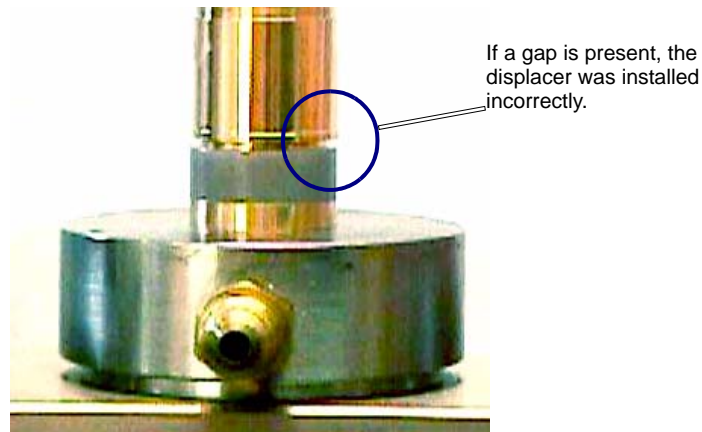

Figure 5-34: Reversed Displacer Example

4. Apply a light coat of Lubriplate (#201304) just inside the bore of the Cylinder and on the end of the cylinder without the large chamfer (Figure 5-35). Slide the Cylinder over the Displacer, Long Seal Ring, and Short Support Ring until it comes in contact with the Check Valve Body.
5. Verify that the end of the Cylinder **without** the large chamfer is against the Check Valve Body.

Caution: *The liquid displacer provides a close tolerance fit inside the bore of the cylinders; however, the cylinder should slide easily over the displacer if the cylinder is kept square with the displacer. It may be necessary to press firmly on the cylinder to push it over the seal ring. If the support ring was not removed during maintenance, the cylinder may not slide over it by hand. In this situation, place a rag over the open end of the cylinder and tap it into place with a soft mallet.*



Figure 5-35: Sliding the Cylinder over the Displacer

6. Repeat steps #3 through #5 for the remaining cylinders.
7. Set the Wet End Assembly aside until it is time to reassemble the Pump.

Replacing the Water Coolant Housing Seal

The low-pressure seal in the coolant housing should be replaced at every rebuild of the pump.

Refer to “Tools Required for Wet End Maintenance” on page 5-6 for a list of tools used to replace the water coolant housing seal.

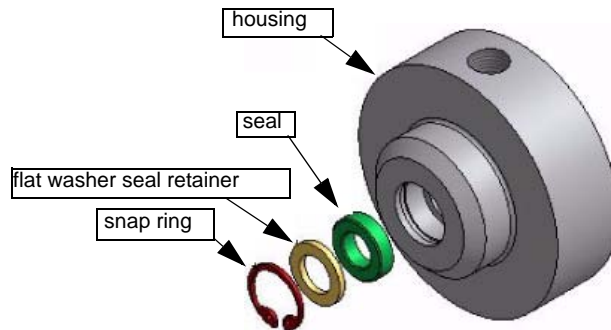

Figure 5-36: Coolant Housing Assembly Components

To replace the water coolant housing seal:

1. Remove the Coolant Housing Assemblies (Figure 5-37) by sliding them forward until they clear the end of the Plungers. The Coolant Housing fits snugly to the bore in the Adapter Block (Figure 5-37) and may be difficult to remove. Use the two Fittings, top and bottom, of the Coolant Housing to rotate the assembly while removing it. During removal, keep it aligned with the bore.

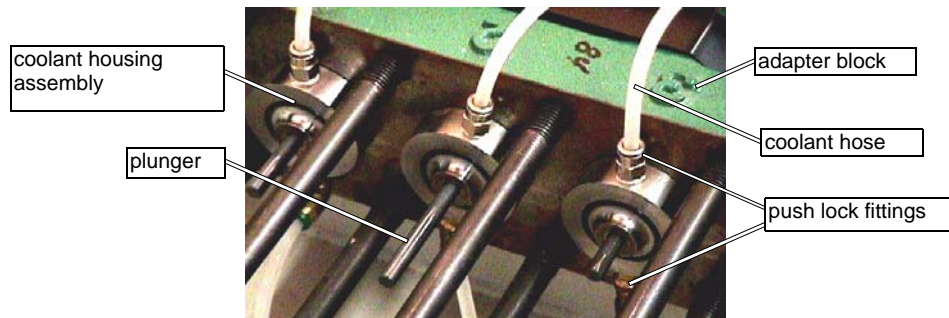

Figure 5-37: Removing the Coolant Housing Assemblies

2. After removing the Coolant Housing, pull the Coolant Hoses out of the Push Lock Fittings by pulling back on the outer ring of the fitting to release the locking device within the Fitting while pulling on the Coolant Hose.
3. Remove the Snap Ring (Figure 5-36) with the set of internal snap ring pliers. Use the small flat-tip screwdriver to lift the Flat Washer Seal Retainer out of Housing bore. Remove the Seal in the same fashion.
4. Apply a small amount of Lubriplate to the lip of the new Seal and install it with the pressure lip, or cup, facing into the Coolant Housing, followed by the Flat Washer Seal Retainer and the Snap Ring.

Caution: *The snap ring must be fully engaged in the snap ring groove. If not fully engaged, it can contact the plunger, damaging its surface.*

5. Set the Coolant Housing Assemblies aside for later pump assembly.

Removing Plunger Assemblies

Removal and inspection of the pump plungers is necessary only if plunger rubbing of the backup ring occurred. Rubbing may be expected if the dynamic seal indicates the plunger was out of alignment, or if the backup ring indicates plunger rubbing.

Caution: *Damaged plungers ALWAYS cause premature dynamic seal failure.*

Plunger damage can not always be seen with the naked eye and should be examined carefully with a low-power magnifying glass. It is usually caused by the plunger rubbing on the backup-support ring or by

foreign material in the pump. Whenever a plunger rubs the backup-support ring, metal adheres to the plunger surface. With extreme rubbing, a rough area showing discoloration of the plunger surface develops. Refer to the section, *Inspecting the Backup-Support Ring Assembly* located on page 5-13.

Note: *Once plunger rubbing has occurred, the plunger assembly must be replaced along with the dynamic seal and backup-support ring. If material is missing from the plunger surface, the plunger assembly, backup-support ring and coolant housing seal must also be replaced along with the dynamic seal.*

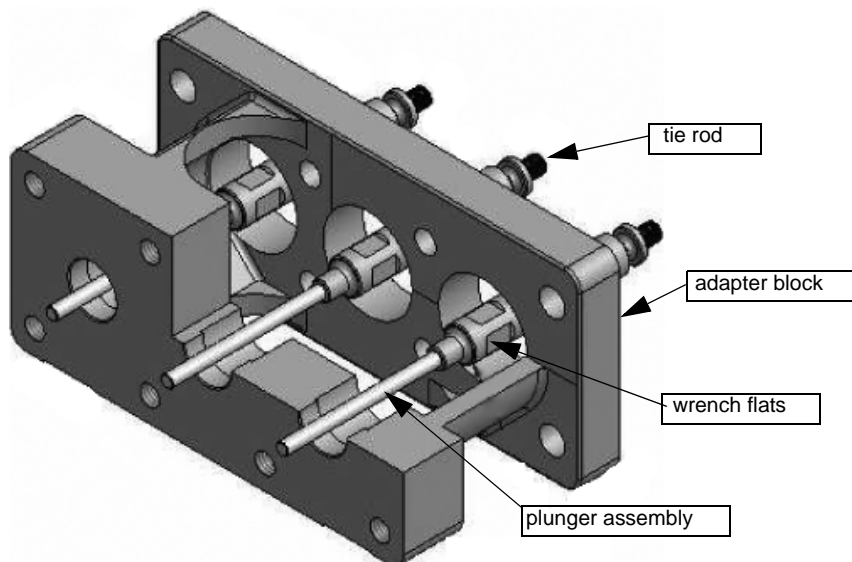

Figure 5-38: Adapter Block, Tie Rod and Plunger Assembly

Refer to “Tools Required for Wet End Maintenance” on page 5-6 for a list of tools used to remove the plunger assemblies.

To remove the plunger assemblies:

1. Remove the Coolant Housings (Figure 5-37), if not already removed.
2. Access to the Wrench Flats on the Plunger Assemblies is through an opening in the top of the Adapter Block. Remove the metal Cover Plate (Figure 5-1) on top of the adapter block and set it aside.
3. Remove the Access Cover Plate on the vertical end of the Belt Guard to gain access to the pulley on the pump crankshaft.



Figure 5-39: Access Cover Plate on Top of Pump Belt Guard

4. Use the belt pulley to rotate the pump crankshaft by hand until the plunger being removed is positioned at bottom dead-center (fully retracted). Only two of the plunger assemblies are accessible at a time.

5. Use the 3/4" crows foot on a 3/8" drive breaker bar with a steady pull to loosen the Plunger Assembly. Avoid jamming the wrench and permanently bending the Plunger Assembly.

Reinstalling Plunger Assemblies

To reinstall the tie rod and plunger assemblies:

1. Ensure that the threads on the Plunger Assemblies (Figure 5-38) and the face and threads of the pistons in the crankcase are clean.
2. Apply the anti-seize lubricant to the mounting face and threads of the Tie Rods.
3. Install the Plunger Assemblies into the crankcase and hand tighten.
4. Rotate the pump crankshaft so the Plunger is at bottom dead-center.

Caution: *The plunger must be at bottom dead-center (fully retracted) when being tightened to avoid bending the plunger assembly.*

5. Using a 3/4" crow's foot and torque wrench, tighten each assembly to a torque of 225 in-lb, or 19 ft-lb (25 N·m).

Assembling the Dynamic Seal Assembly

Refer to "Tools Required for Wet End Maintenance" on page 5-6 for a list of tools used to assemble the dynamic seal assembly.

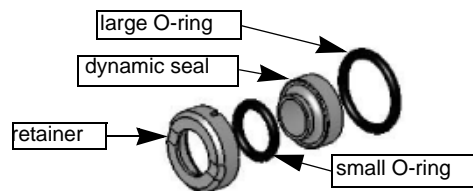

Figure 5-40: Dynamic Seal Assembly Components

To assemble the dynamic seal assembly:

1. Place the Small O-ring on the extended lip of the Dynamic Seal.
2. Apply a small amount of Lubriplate to the outside of the Small O-ring.
3. Snap the metal Retainer over the Small O-ring onto the Dynamic Seal. The Retainer must be held square and may require some force to snap into place. An Arbor press may be used to lightly press the retainer onto the dynamic seal.
4. Place the Large O-ring over the outside of the back of the Dynamic Seal.

Reassembling the Pump

This section provides procedures for reassembling the OMAX pump.

WARNING! After the pump is reassembled, the crankcase should be turned over by hand to verify all plungers reach their full stroke without contacting the check valve retainers. BE CAREFUL NOT TO CATCH ANY FINGERS BETWEEN THE DRIVE BELT AND SPROCKETS.

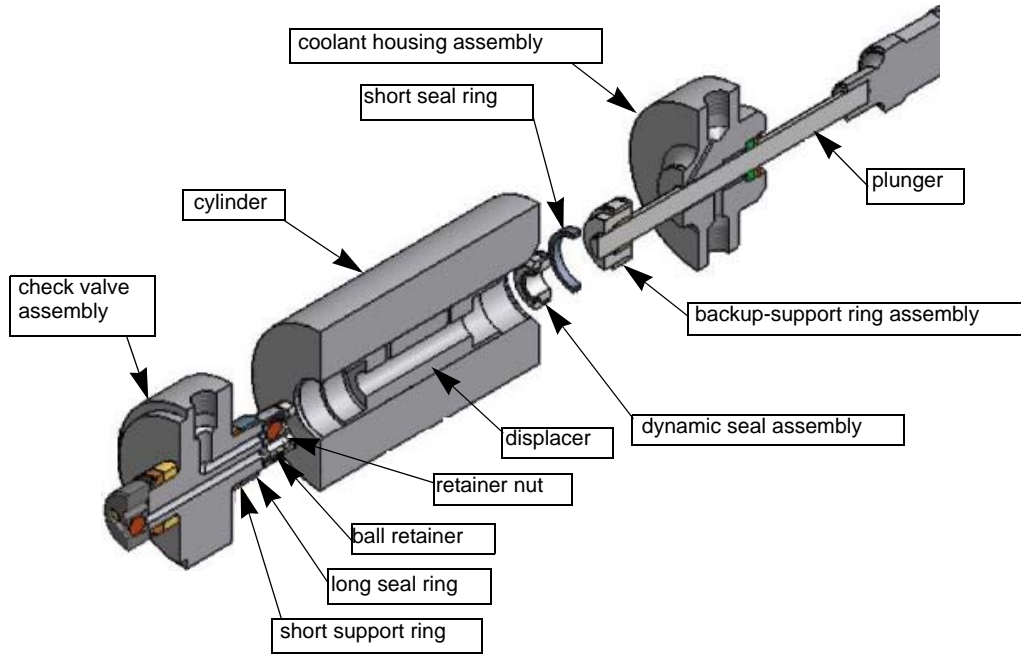

Figure 5-41: High-pressure Wet End Assembly

To reassemble the OMAX pump:

1. For convenience, rotate the pump Crankshaft until the center Plunger is at top dead center (maximum extension). The ends of the other two Plungers should then be even and extend out far enough for assembly of the wet end without further rotation of the crankshaft.
2. Apply a light coat of extreme pressure lube (or Blue Goop) to the area of the Coolant Housing Assembly that engages into the Cylinder bore.
3. Slide the Coolant Housing Assembly over the Plunger until it is fully engaged into the bore in the Adapter Block (Figure 5-42). Note that the plunger is not rigidly held and can be moved slightly for alignment with the Coolant Housing Assembly.

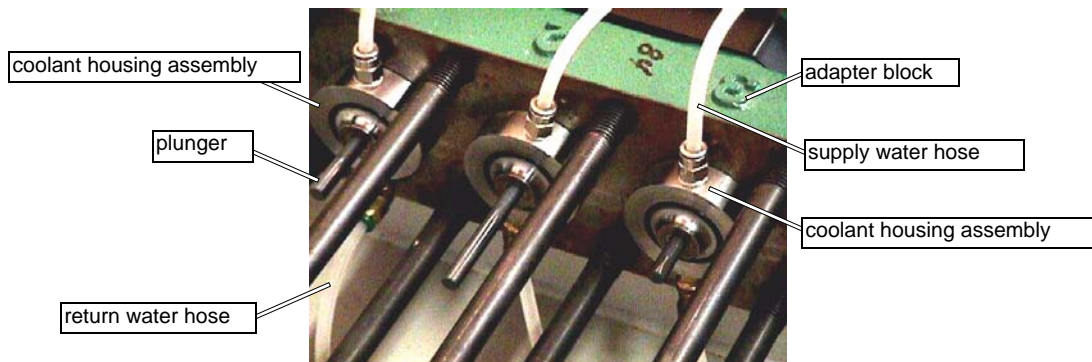

Figure 5-42: Coolant Housing Assembly Installation and Hose Connections

- Trim the low-pressure water supply and return hoses off at about ¼" from their ends making them square with straight edges. Insert them into the push lock fittings on the coolant housing assemblies.

Note: Hoses from the low-pressure supply manifold block should be connected to the upper fittings on the coolant housings. The hoses connected to the lower fittings should return water to the water tank.

- Slide the Short Seal Ring onto the Backup-support Ring Assembly.



Figure 5-43: Installing the Short Ring Seal onto the Backup-Support Ring Assembly

- Slide the Backup-support Ring Assemblies onto the Plungers with the black bushing inside the Backup-support Rings toward the Coolant Housing Assembly. Push the Backup-support Ring Assembly down the Plunger until it rests against the Coolant Housing Assembly:

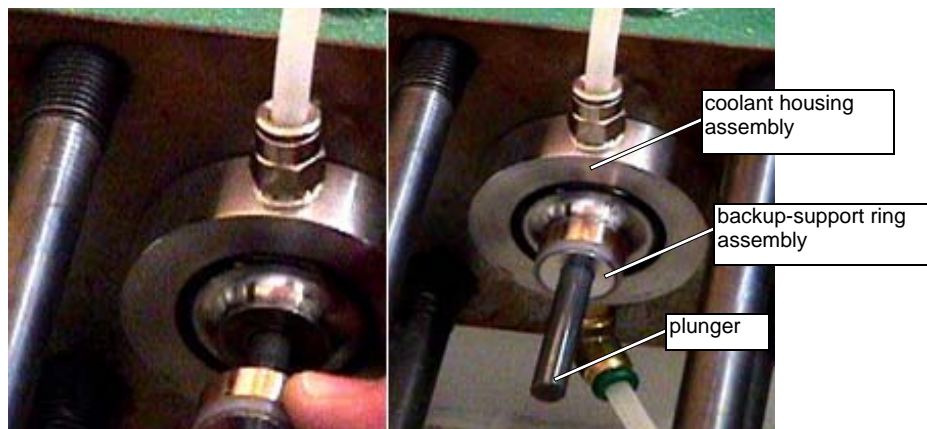

Figure 5-44: Sliding the Backup-support Ring Assembly onto the Plunger

- Slide the assembled Dynamic Seal Assembly onto the Plunger until it rests against the Backup-support Ring Assembly. The flat end of the Dynamic Seal Assembly must be against the Backup-support Ring Assembly, and the metal retainer must be on the side away from the Backup-support Ring Assembly.

Note: The dynamic seal assembly is an interference fit on the plunger. It can be difficult to install at times. You may find it helpful to use the OMAX and removal/installation tool (Figure 5-6) as a pushing device to install the dynamic seal assembly.

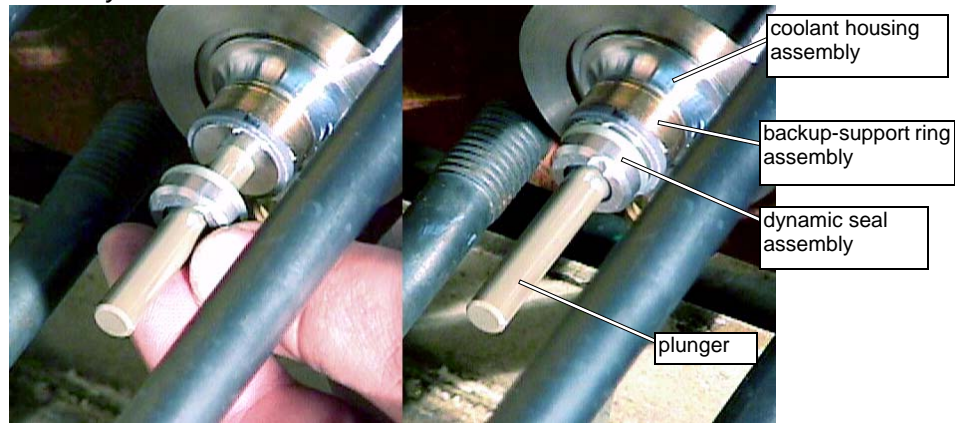

Figure 5-45: Sliding the Dynamic Seal Assembly onto the Plunger

8. Apply a light coating of Lubriplate to the exterior surface of the outer ring on the Backup-support Ring Assemblies.
9. Slide the Wet End Assembly previously set aside over the Plungers. After starting to slide the Wet End Assembly into position, do not pull the Wet End Assembly back or cock it as this could cause internal components to dislodge from their assembled position. As the Cylinders begin to slide over the Short Seal Rings (Figure 5-46), they may, or may not go on all the way by hand. The small gap that occurs between the end of the Cylinders and the Coolant Housings Assemblies closes when the Wet End Assembly is correctly torqued.



Figure 5-46: Sliding the Wet End Assembly over the Plungers

10. Install the Clamp Plate and two Nuts on the Studs numbered 1 and 2 in Figure 5-47, using a generous amount of anti-seize compound on both the Stud threads and the face of the Nuts that face the Clamp Plate. Tighten the two Nuts evenly until they are snug. An even gap of approximately 0.070" (1.78 mm) should remain between the end of the Cylinders and the Coolant Housing Assemblies. Install the remaining Nuts hand tight, again using a generous amount of anti-seize on the Stud threads and Nut faces.

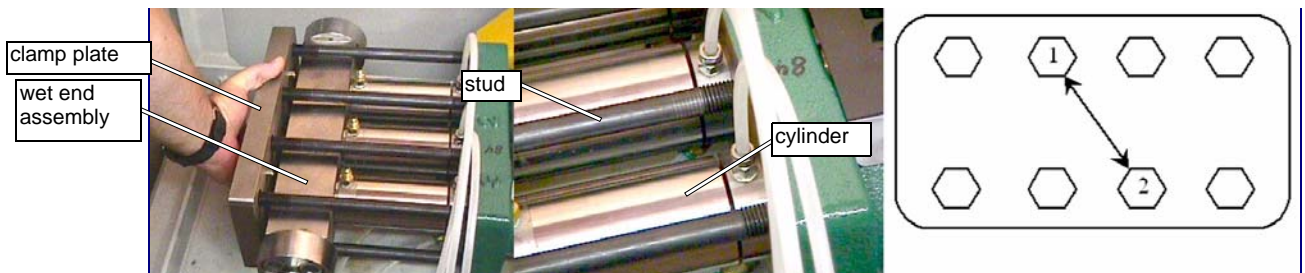

Figure 5-47: Installing the Clamp Plate

Caution: *It is extremely important that sufficient anti-seize compound be used to lubricate the threads and surface between the nut and clamp plate so that the torque applied properly loads the ring seals and studs.*

- To ensure that an evenly distributed load is developed on the Clamp Plate and Cylinders, torque each Nut one-half turn in succession. Using the 24 mm socket (or 15/16" socket) and torque wrench, follow the tightening sequence specified below, until a torque of 175 ft-lb (237 N-m) is achieved on each Nut.

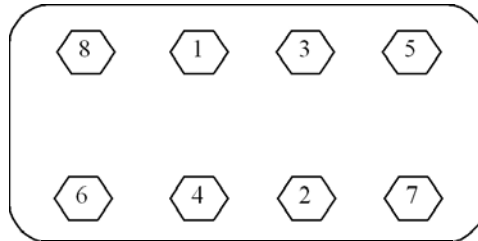

Figure 5-48: Clamp Plate Torque Sequence for Clamp Plate Nuts

Caution: *Verify that all nuts are tightened evenly in the order specified in Figure 5-48 to avoid internal component damage and to achieve an even loading of the ring seals and studs.*

- Rotate the pump Crankshaft by hand until each Plunger crosses top dead-center to ensure the Plungers clear the inlet retainers and no binding exists in the wet end assembly that prevents a smooth rotation.
- Reinstall the access cover onto the belt guard (Figure 5-39).
- Complete the Pump assembly by connecting the outlet high-pressure tubing and low-pressure inlet hoses.

Maintenance of the Water Filtration System

Proper maintenance of the four water filters in your OMAX low-pressure water system directly impacts the performance of your OMAX machine.

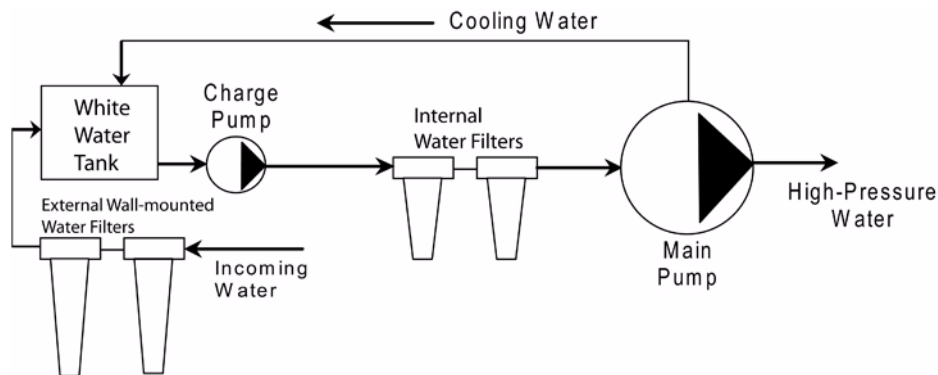

Figure 5-49: The Low-pressure Water Filtration System

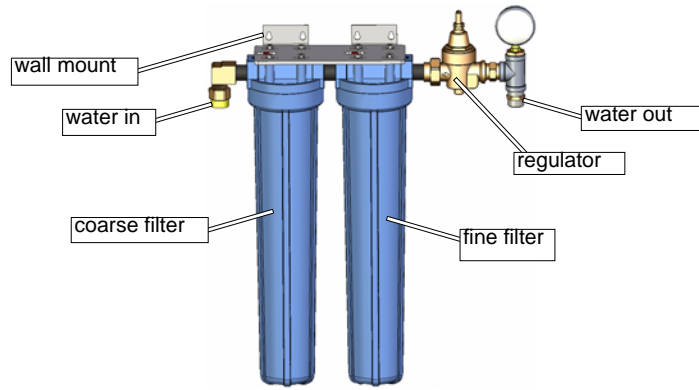

Figure 5-50: Incoming Water Filters - Wall Mounted

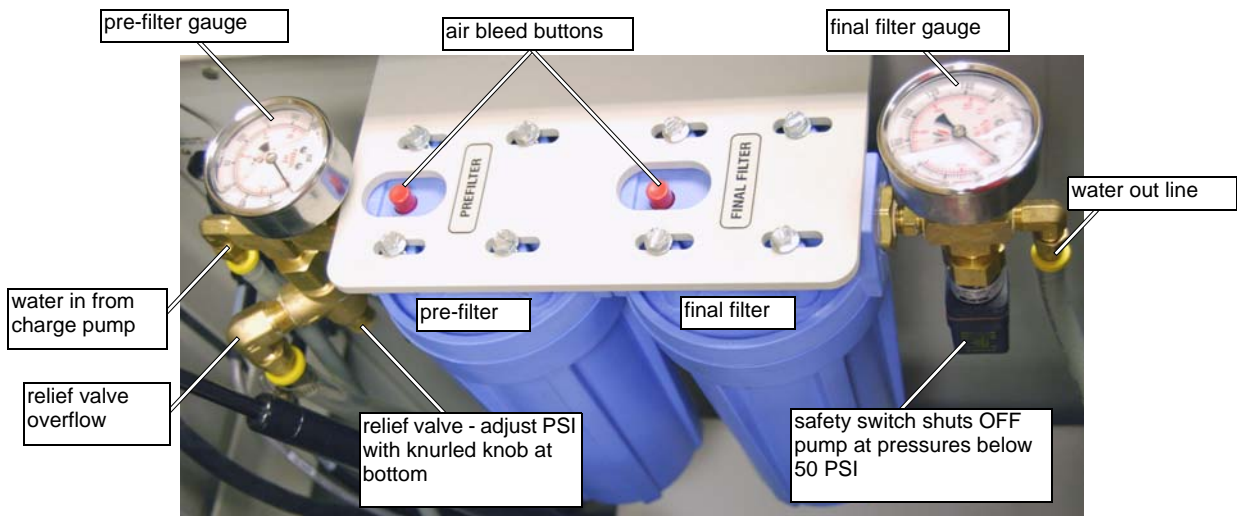

Figure 5-51: Pump Internal Water Filtration System

How the low-pressure water system filtration works:

1. Water from your local source is piped into your building and is plumbed to two OMAX wall-mounted pre-filters (a 3 micron “course” filter and a 1 micron “fine” filter). See Figure 5-50.

Note: Additional systems such as a Reverse Osmosis, a water softener, or an EBBCO closed loop system may be installed at this point for additional water treatment when needed.

2. This filtered water then flows to the white reservoir tank (Figure 5-53) located under the crankcase in the pump cabinet.
3. When the Charge Pump is turned ON, water from the white tank reservoir feeds the preconditioned water to the 10” blue filters in the pump cabinet (Figure 5-51).

Note: The pre-filter gauge (Figure 5-51) reads the pressure of the charge pump before the filters (Pressure should read higher than 75 psi and can be adjusted up to 120 psi)

4. Water is pulled by the charge pump from the white tank reservoir through a 200 mesh strainer (OMAX P/N 200935) and pumped to the pre-filter (.5 micron), through the 2nd final filter (.2 microns), and then into the pump.
5. The final filter gauge reads the pressure after both filters have filtered the water.

Note: The difference in pressure between the gauges when the pump is running at high RPM determines filter status. When the pressure difference between the gauges is more than 20 psi with the pump running at high RPM, the filters are becoming clogged and should be replaced. Always change both filters. When filters are new, the difference in pressure between the two gauges is close to zero.

Preventing problems in the low-pressure water system:

When the low-pressure water system is not maintained properly, the following error message can appear: "Charge pump pressure low." This message is typically caused by the charge pump not being able to develop sufficient water pressure, triggering the 50 PSI low-pressure switch, causing the high-pressure pump to shut down and the "Charge pump pressure low" message to appear.

This situation can be prevented by following these suggestions for filter maintenance:

- When one filter requires replacement, change all four filters.
- Change the 20" wall filters monthly or until a specific replacement interval can be determined.
- Increase the interval between wall filter changes until the 10" blue pump filter interval starts to fall (when running at high RPM). Use this as a baseline for the interval for the wall filter changes.
- If the pressure difference between the gauges is more than 20 psi when running the pump at high RPM, change the pump's 10" blue filters.
- Record the time between all filter changes.
- Clean the 200 mesh strainer in the Charge Pump reservoir every 3 months or more frequently if needed.

Note: If problems with your water supply are suspected, send a sample of water from the white reservoir tank in the pump to OMAX for a water test. Take the sample after running the pump for approximately 20 minutes. This sample will let you know if additional water treatment may be required.

Changing Water Filter Cartridges

The OMAX pump uses two filters for the low-pressure water from the water tank (Figure 5-52). Pressure gauges mounted on top of these water filters monitor the water pressure both before and after the two filters. When the pressure differences between these two gauges becomes greater than 20 psi (140 kPa), the filter cartridges need replacing.

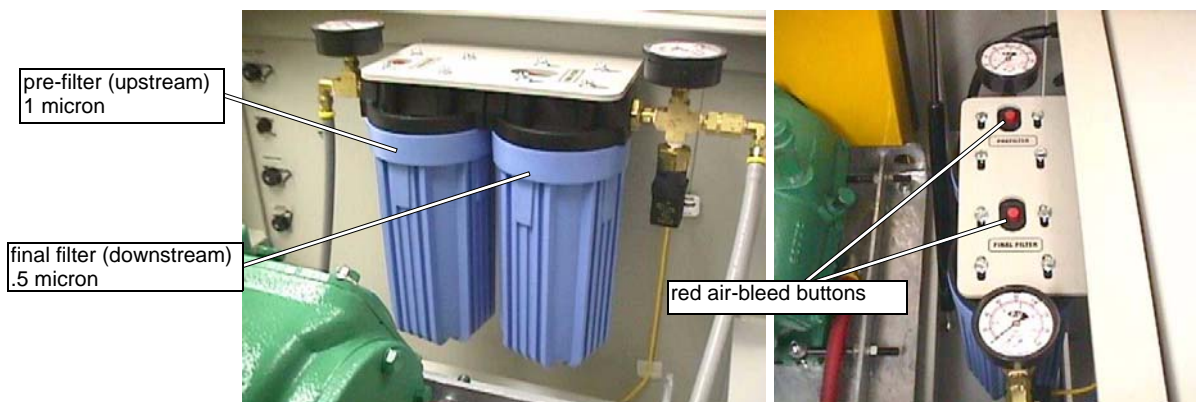

Figure 5-52: Low-pressure Water Filters with Pressure Gauges

To replace the water filter cartridges:

1. Position the waterjet nozzle in a safe location, or remove the nozzle.
2. Turn OFF the charge pump.
3. Lift the pump's cover lid and remove the front panel cover.
4. Unscrew each filter housing, using the spanner wrench provided (OMAX P/N 200773).
5. Remove and discard the filter elements.
6. Wash and rinse the filter housing to remove all sediment and coatings from inside the housing.

7. Rub a thin coating of oil (Lubriplate or equivalent) on the ends of the coarser 1 micron filter element. Install it upstream. Reinstall the upstream filter housing.
8. Rub a thin coating of oil (Lubriplate or equivalent) on the ends of the finer .5 micron filter element. Install it downstream. Reinstall the downstream filter housing.
9. After replacing the two elements, turn ON **only** the charge pump.
10. Hold down the red buttons on top of the filters next to the pressure gauges (Figure 5-52) to bleed air from the filters.

Note: *If all the air is not purged from the filters, the charge pump cannot develop sufficient pressure and the main pump unit will shut down, displaying the fault message "Charge Pressure Low" on the keypad screen. To recover from this fault, press the "RESET" button on the keypad. Start the charge pump and bleed any remaining air from the water filters.*

11. Turn OFF the charge pump.
12. Replace the front panel cover and lower the lid.
13. Reinstall the nozzle.

Cleaning the Pump White Water Tank

Seal debris and particles will accumulate over time in the small, white water tank in the pump unit. The tank and charge pump suction screen should be cleaned at every pump rebuild, or more frequently when necessary.

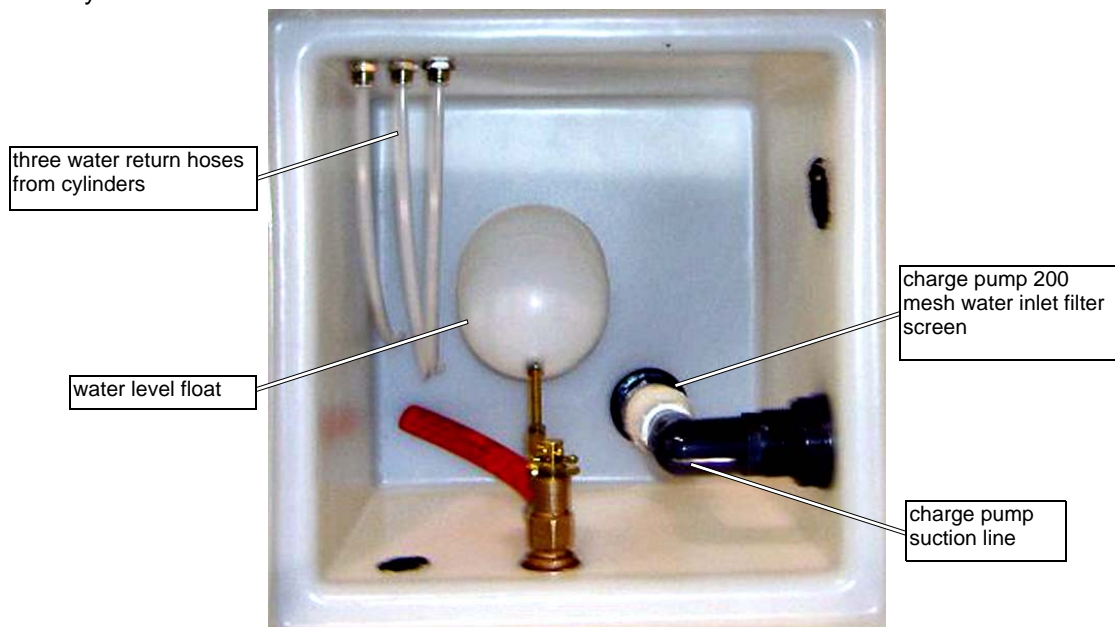

Figure 5-53: White Water Tank

To clean the water tank and charge pump suction screen:

1. Ensure that power to the Charge Pump is OFF.
2. Remove the pump's front panel allowing access to the Water Tank (see Figure 5-53).
3. Remove the water tank lid.
4. Shut the water supply to the Pump unit OFF.
5. Empty the tank water by powering the charge pump ON.
6. Once the water level is at or below the charge pump suction inlet, power the charge pump OFF.
7. Remove the remaining tank water by mopping it up using a clean rag.

8. Once tank water has been removed, wipe the interior of the tank clean.
9. Remove the charge pump water inlet filter screen from the end of the suction line.
10. Clean the water inlet filter screen by flushing it backwards with water and blowing it dry with shop air.
11. Reinstall the cleaned filter screen and firmly tighten it in place by hand.
12. Turn the water supply ON, allowing the water tank to fill.
13. Power ON the charge pump and bleed any air from the two filters by holding down the red buttons on top of the filters to bleed air from the filters (see Figure 5-52).
14. Power the change pump OFF.
15. Replace the water tank lid.
16. Replace the pump's front panel.

Changing Crankcase Oil

To avoid excessive wear and damage to the crankcase bearings, it is important to change the crankcase oil according to the intervals specified in the maintenance schedule. The oil must also be changed anytime it becomes contaminated with water or other debris.

Always use SAE 30 (ISO 100) non-detergent motor oil. Use of other types of oil may shorten pump life. If the temperature in the pump's physical environment exceeds 90° F (32° C), use SAE 40 (ISO 150) non-detergent motor oil. The crankcase holds two quarts (1.9 L) of oil.

Note: *Whenever extended periods of pump operation at a motor RPM that is less than shown below are anticipated, you should add one additional quart (3 total) of oil to the pump crankcase.*

Pump Model	Add additional quart of oil if RPM is less than
P3050V	750
P3055V	850
P4055V	650

To change the oil in the pump crankcase:

1. Disconnect the pump's AC power source.
2. Lift the pump's cover lid and remove the front panel cover.
3. Place a drain pan at the end of the red Oil Drain Hose to catch the oil when the Plug is removed from the Fitting.
4. Allow the oil to drain.
5. To force out remaining oil, apply a small amount of shop air to the hole in the oil filler tube with the filler cap still in place.
6. Replace the plug at the end of the red drain hose.
7. Refill the oil through the filler pipe.
8. Replace the filler pipe cap.
9. Replace the front cover.

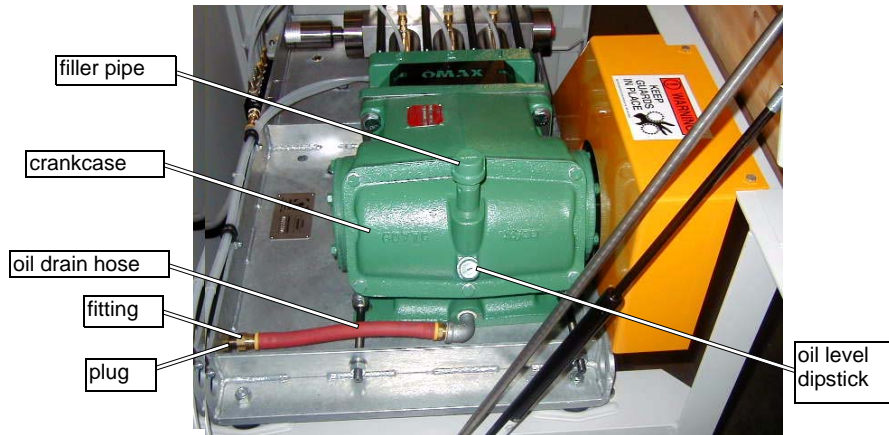

Figure 5-54: Pump Crankcase, Oil Drain Hose, Filler Pipe

Maintaining the Pump Motor Belt

The heavy-duty belt connecting the OMAX pump with the electric motor occasionally requires re-tensioning or replacement. Periodically inspect the belt, looking for cracks, frays, or other wear spots. If you see cracks, frays, or damaged/missing teeth, replace the belt immediately.

The belt should deflect 1/4" - 5/8" (6.5 - 16 mm) when pushed with a force of approximately 34 - 37 pounds (15 - 17 Kg) midway between the pulleys. If the belt deflects more or less than 1/4" - 5/8" (6.5 - 16 mm) when pushed, adjust the belt tension using the following procedure.

Caution: *Never tighten the belt to remove all deflection. This shortens the belt life.*

Refer to "Tools Required for Wet End Maintenance" on page 5-6 for a list of tools used in maintenance of the pump's motor belt.

To service the pump belt:

1. Disconnect the pump's AC power source.
2. Lift the pump's cover lid and remove the pump's front and rear panel covers.
3. Disconnect the high-pressure plumbing from the pump and remove the pump's rear cover panel.
4. Remove the belt guard cover using the 10 mm socket.



Figure 5-55: OMAX Pump Belt Guard Cover

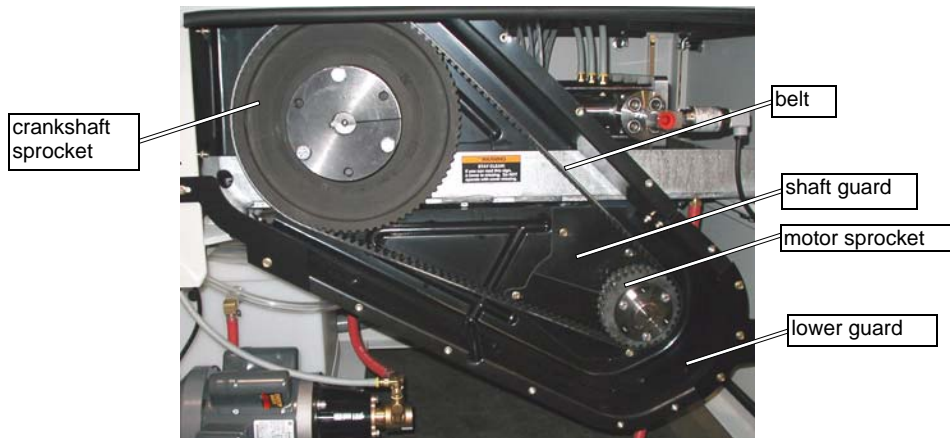

Figure 5-56: OMAX Pump Belt with Belt Guard Cover Removed

5. Loosen the pump crankcase mounting bolts. Loosen nuts on the two eye-bolts located at rear of crankcase. If the belt is being replaced, loosen it until to increase the slack, allowing it to be removed from the sprockets.
6. Install the replacement belt, ensuring the teeth mesh properly.
7. Using the eye-bolt outside nuts, tighten the belt to the tension specification provided above.
8. Tighten the securing nuts until snug, then check the pulley alignment with a straightedge, adjusting it as needed.
9. Tighten the security nuts.
10. Fully tighten all crankcase mounting bolts.
11. Reconnect all the high-pressure plumbing to the pump.
12. Replace the belt guard cover.
13. Replace the pump's front and rear covers.
14. Close the cover lid.

Lubricating the Electric Motor

The pump's main electric motor comes with pre-lubricated ball bearings. The motor's ball bearings should be lubricated at intervals according to the pump's hours of service per year as follows:

Hours of Service Per Year	Relube Interval
5000	3 years
Continuous	1 year
Seasonal (Idle 6 months or more)	1 year (beginning of season)
Continuous High Ambient Temp. Dirty or Moist Locations High Vibrations	6 months

Use these recommended high-quality ball bearing lubricants:

Consistency	Type	Typical Lubrication
Medium	Polyurea	Shell Dolium R and/or Chevron SR1 2
	Sodium-Calcium	Lubriko M6

Refer to "Tools Required for Wet End Maintenance" on page 5-6 for a list of tools used in lubricating the electric motor.

To lubricate the motor's ball bearings:

1. Disconnect the pump's AC power source.
2. Remove the pump's front and rear panel covers.
3. Access the shaft-end of the motor (refer to Figures 5-55 and 5-56):
 - a. Remove the outside belt guard cover.
 - b. Remove the inside shaft guard.
 - c. Remove the lower portion of the belt guard.
4. Locate the grease fittings located on each of the motor ends.
5. Remove the pipe plug located opposite the grease fitting.

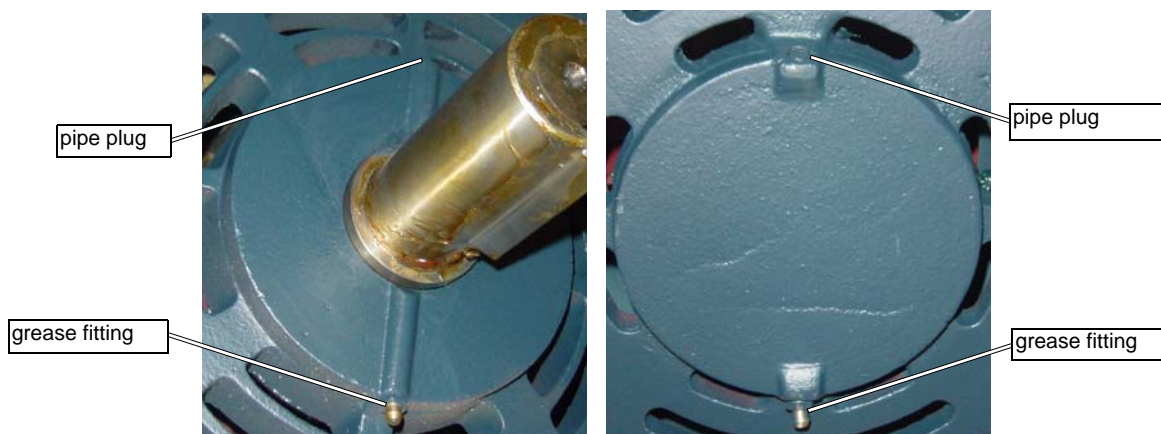

Figure 5-57: Location of Front and Rear Motor Grease Fittings and Pipe Plugs

6. Wipe the tip of each grease fitting clean and connect the grease gun.
7. Apply 2-3 full strokes from the grease gun to each grease fitting.
8. Wipe up any grease forced out the hole and replace the pipe plugs.
9. Replace the belt guard components.
10. Replace the pump's front and rear panel covers.
11. Close the pump's cover lid.
12. Run the motor for 20 minutes before opening up the panel covers and replacing the pipe plugs removed previously.

Caution: *Keep the lubricant clean. Always lubricate at motor standstill. Always remove and replace the pipe plugs at motor standstill. Never mix petroleum lubricants and silicone lubricants in motor bearings.*

Replacing the Electrical Enclosure Air Filters

The two air filters located on the inside of the electrical enclosure door should be replaced every month, or more often, depending upon environmental conditions. In excessively dirty or dusty environments, it may be necessary to replace the air filters weekly.

Caution: *Failure to maintain clean air filters can result in overheating of the electrical enclosure, resulting in an over-temperature shutdown of the variable frequency drive (VFD).*

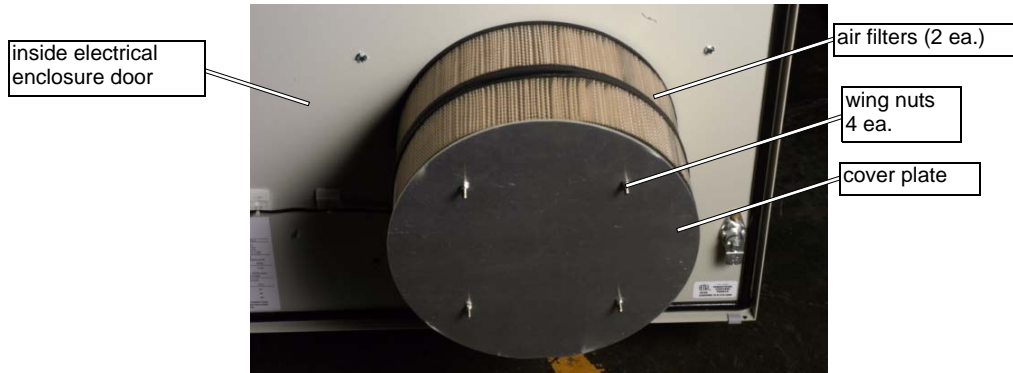

Figure 5-58: Electrical Enclosure Air Filters

To replace the air filters:

1. Disconnect the pump's AC power source.
2. Open the door to the pump's electrical enclosure.
3. Remove the four wing nuts and the round cover plate.
4. Remove the two air filters.
5. Replace the air filters with FRAM #CA326, or equivalent.
6. Replace the cover and wing nuts.
7. Close the door to the electrical enclosure.

Resealing the Safety Valve

The safety valve (P/N 300756) in the OMAX pump functions to prevent an excessive build up of water pressure in the system plumbing.

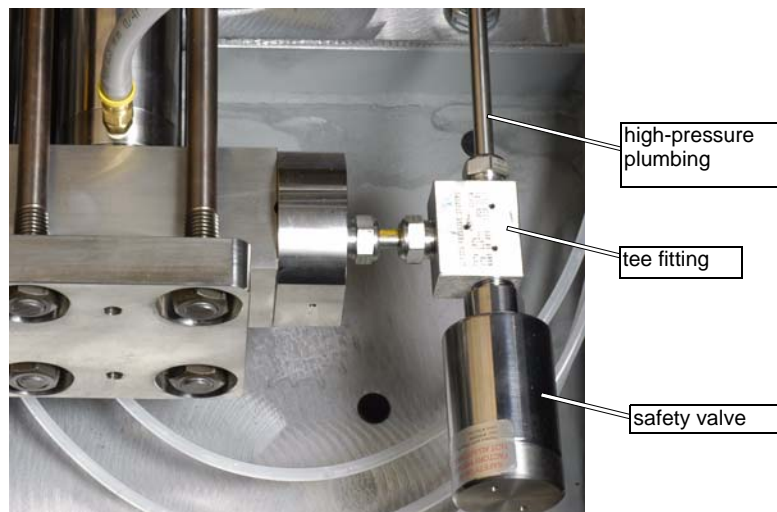

Figure 5-59: OMAX Pump High-pressure Safety Valve

During normal operation, the pump can reach pressures up to 60KSI. At this pressure, the VFD slowly lowers the motor's RPM to prevent overpressuring the system. If lowering the RPM does not prevent an overpressure condition, the safety valve will activate when a pressure of 66 KSI is reached. An activated valve should reseal itself OK, but could begin to leak after resetting itself a number of times. When leaking occurs, resealing the safety valve is required.

When the safety valve activates, there probably is another issue going on with your machine. It may simply be a deadhead during either a cut or traverse - indicating a plugged orifice in the cutting head or the dump valve. Harder issues to identify are pressure spikes created at the moment of shift between the cut and a traverse.

The high-pressure water seal occurs between the seat and the first ball (Figure 5-60). The body contains a large spring that pushes on the ball and seat creating a water seal up to 66,000 PSI (+ or – 2K). When leaks occur in the safety valve, they will be observed at the 4 holes in the large body, which normally are dry with no water inside.

Note: *The pump is designed to shut off when pressure reaches 63 KSI or above. If the pressure rises too rapidly, it may exceed 63 KSI. The safety valve is designed to activate at 66 ksi (± 2 ksi).*

WARNING! *Never attempt to adjust the safety valve, doing so creates a safety hazard!*

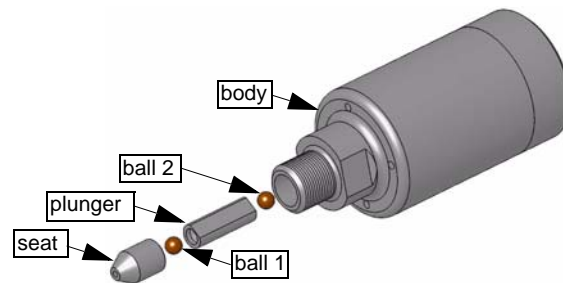

Figure 5-60: Safety Valve Internal Components

To Reseal the Safety Valve:

Refer to “Tools Required for Wet End Maintenance” on page 5-6 for a list of tools used in resealing the safety valve.

1. Use the two 1" open end wrenches to unscrew the safety valve from the tee fitting.

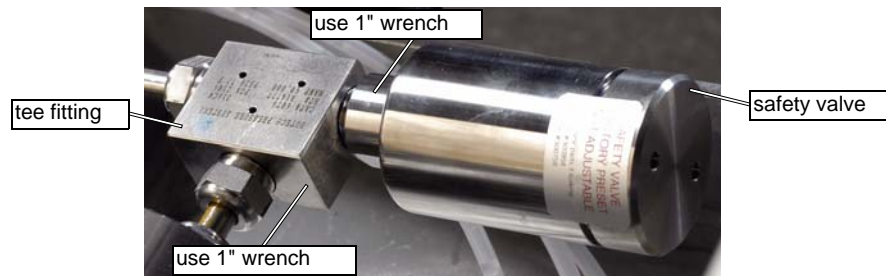

Figure 5-61: Safety Valve Removal

2. Remove and discard the two balls and seat (Figure 5-60).
3. Clean the plunger and safety valve body with water, using air to flush the water out of the spring chamber.
4. Spray some LPS lubrication into the holes and blow out with air to prevent rusting of the valve.
5. Rub Blue Goop onto both ends of the replacement seat, the two replacement balls, and the threads of the safety valve body.

6. Stack the parts together (refer to Figure 5-60) and screw the assembled body into the tee fitting by hand.
7. When screwed in as far as possible by hand, torque the body to the tee fitting using the 1" open end wrench on the tee fitting and the 1" crows foot and torque wrench on the Safety Valve (refer to Figure 5-61). Tighten to 50 - 75 foot pounds.
8. Lower the RPM at startup for a few minutes to ensure no pressure spikes occur that will fail the valve again.
9. With the pump running at high pressure, inspect the safety valve closely for any signs of water leakage.

OMAX Table Maintenance

This chapter covers the maintenance normally required to ensure reliable operation of your OMAX JetMachining Center. For maintenance of your OMAX pump, please refer to *The OMAX Pump Service and Maintenance Guide* (P/N 400407).

WARNING! All maintenance activities must be performed by qualified personnel.

Maintenance Schedule

Use of the maintenance schedule and the maintenance log (page 6-2) provided in this chapter is important in ensuring proper equipment performance and accuracy. Typically, the frequency of most maintenance activities is based upon the length of time that the equipment has been in operation; however, harsher than normal environmental factors can require that maintenance activities be scheduled at a frequency greater than indicated in the table below.

	Activity	See Page	Frequency
Tank Maintenance	Wash away the abrasive accumulation from the equipment and work area	6-7	Daily and as often as required to maintain a clean working environment
	Remove all garnet, sludge, and slugs from the tank bottom	6-7	Whenever abrasive particles begin to excessively accumulate on the material being machined
	Inspect individual slats for wear. Replace and rotate	6-9	Inspect and rotate monthly. Replace when excessively scored and no longer stable.
	Clean the outlet water filter	6-8	Check monthly (Figure 6-3)
	Run tank cleaning program		As needed when using the OMAX Solids Removal System (SRS)
	Add anti-bacterial chemicals to the tank water controlling tank odor and bacteria growth	6-8	Before chemicals in the floating device become depleted and bacteria growth can thrive. Check monthly.
Table Maintenance	Lubricate carriage components	6-14	Yearly
	Lubricate X-axis components	6-16	Yearly
	Lubricate the Motorized Z-Axis	6-17	Yearly
	Inspect the timing belts	6-9	Yearly
	Inspect the high-pressure plumbing	6-3	Yearly
	Rebuild the abrasivejet nozzle	6-24	As required to maintain cutting quality
PC-based Controller Maintenance	Clean Keyboard and Mouse	6-59	As required
	Replace air filters	6-60	Every three months or sooner when necessary
	Clean monitor screen	6-59	As necessary for sharp viewing
	Update OMAX software	6-61	As soon as updates are released by OMAX
	Reboot PC-based controller	6-61	Daily
	Run Windows Defragmenter program	6-61	Monthly
	Replace CMOS battery in the PC-based Controller	6-61	as needed (normally will last approximately 5 years or more)

Tools Required for Table Maintenance

The following table lists all tools used in the pump and nozzle rebuild procedures for the individual components.

Tools Required	Nozzle Assembly Rebuild	Dual ON/OFF Valve Rebuild
Open End Wrenches		
1-3/8"		X
1/4"		X
1/2"	X	
5/8"	X	
11/16"	X	
3/4"	X	
13/16"		X
1"	X	X
1-1/4"	X	
1-1/8"	X	
1-5/8"	X	
Box End Wrenches		
1/2"	X	
Crow's Foot wrenches		
1-1/8"		X
Torque wrenches		
250 in-lb (28.2 N·m)	X	X
100 ft-lb (136 N·m)	X	X
Allen Wrenches		
3 mm		X
5 mm	X	
Pliers		
Channel lock		
Needle nose		X
Lubricants		
Anti-seize P/N 202563	X	
Lubriplate P/N 201304	X	X
Extreme Pressure Lube (EPL) P/N 202496	X	
Blue Goop anti-galling compound P/N 302692	X	X
OMAX Special Tools		
0.550" push tool x 1.2"	X	
Filter Seal Assembly Removal Tool	X	
Inlet body removal tool	X	
Spanner wrench (supplied with TAJ)	X	
Inspection Tools		
Magnifying glass (or microscope)	X	
Other		
Arbor Press	X	
Pin Gauge	X	
Ultrasonic cleaner	X	
Repair Kit (P/N 301927)		X
Electronic weighing scale	X	
Drift tool 3" long; 0.330" diameter	X	
Applicable OMAX drawings	X	X
Nozzle Rebuild DVD	X	

Maintaining the High-pressure Plumbing System

The high-pressure plumbing routes the water from the high-pressure pump to the abrasivejet nozzle. This system requires periodic inspection for leaks, etc. Inspection should include the tubing, all the high-



pressure fittings, the swivels, and the Dual ON/OFF valve. When fitting leaks occur, power OFF the pump, release any remaining high pressure, and re-torque the leaky fitting. If the leak persists, verify that the collar (Figure 6-1) is backed off, allowing at least three threads to show which is necessary for proper seating. Whenever a leak continues, the sealing surface is probably eroded which requires that the fitting be disassembled and any eroded parts replaced.

WARNING! *Properly preparing and connecting ultra high-pressure (UHP) tubing and fittings is critical in maintaining a safe and leak-free high-pressure system.*

The following components are typical in a ultra high-pressure fitting:

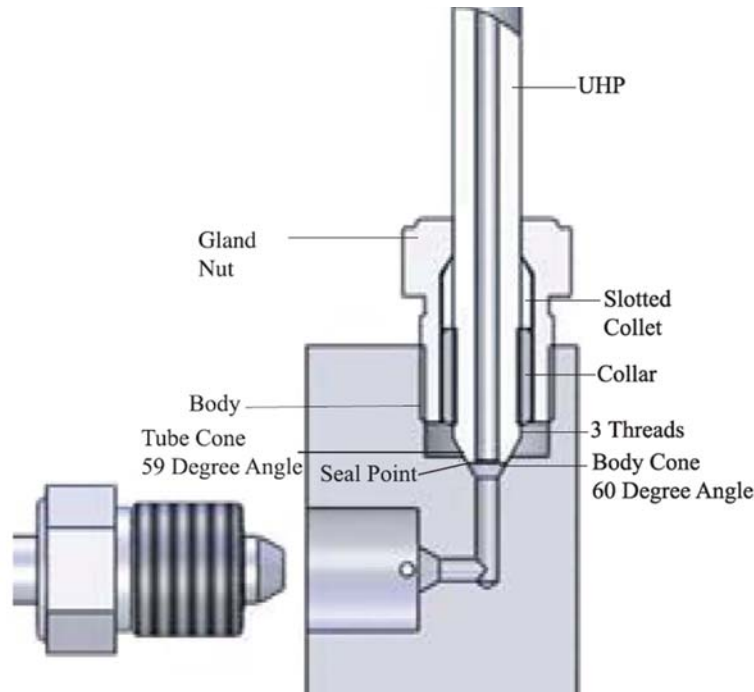

Figure 6-1: Components of the Ultra High-pressure Fitting

Ultra High-pressure (UHP) Tube

The tubing that transports the water under high pressure.

Tube Cone

The end of the tubing is coned at a 59° angle allowing it to seat with the 60° angle body cone.

Tube Thread

Tube threads are left-handed, allowing the tubing to mate with the collar during assembly.

Body

This is the female tubing receptacle. Examples are ELL (90°) fittings, TEE fittings, swivel fittings, and or ON/OFF valve fittings.

Body Cone

The body is coned at a 60° angle, allowing it to seat with the 59° angle of the tube cone.

Body Thread

The body threads are right-handed.

Slotted Collet

The slotted collet provides the correct spacing between the collar and the gland nut. It also provides a slip capability when the gland nut is being tightened during installation.

Collar

The collar threads are left-handed and screw onto the end of the tubing to prevent the gland nut from slipping off the tube end.

Weep Hole

This is a designed leak point that allows fluid to escape whenever fitting pressure exceeds the maximum sealing point.

Creating a High-Pressure Seal

Maintaining the proper cone angles on the body and tube is critical in creating a high-pressure seal (Figure 6-1). This seal is created when the angled (59°) metal edges of the tube cone seats press against the metal edges inside the body cone which has a slightly larger angle (60°). This slight difference in angles between the body and tube cones creates a tight metal-to-metal seal between both components.

Using Blue Goop® Thread Lubricant

All stainless steel high-pressure fittings require the application of a quality thread lubricant such as Blue Goop.

Note: *Blue Goop functions as a lubricant; it is not a thread sealer.*

This lubricant, when applied correctly, can prevent the stainless steel components from galling and seizing. Unfortunately, it is all too common that excessive amounts of Blue Goop lubricant are used which then introduces a variety of unnecessary machine problems such as the contamination and fouling of machine components. To avoid this, OMAX recommends applying Blue Goop using the following procedure:

1. Prior to applying Blue Goop, knead the tube contents to work the oil throughout the goop since the oil and solids tend to separate.

Note: *If several fittings are to be assembled, placing a dime-sized amount of Blue Goop onto a clean, disposable surface is recommended.*

2. Use an acid brush (P/N 202149) to apply the Blue Goop onto each component that requires lubrication.
3. Apply the Blue Goop at the start of the male threads. When threading on the female component, the Blue Goop becomes evenly distributed.
4. Refer to Figure 6-2 for an example of the correct amount of Blue Goop to apply.

Caution: *A small amount of Blue Goop goes a long way. Use it sparingly!*



too much Blue Goop



correct amount of Blue Goop

Figure 6-2: Apply the correct amount of Blue Goop to your fittings.

Assembling the UHP Fitting

Caution: *Always use two wrenches when torquing UHP Fittings!*

1. After the tubing and body have been properly coned and threaded, slip the **gland nut** (Figure 6-1) onto the **tubing**.
2. Screw the **collar** onto the threaded end of tubing, observing the following *Three Thread Rule*:

Three Thread Rule

Always allow three screw threads to be exposed either on the end of the tubing or between the collar and coned end of the tubing. This allows the tube to fully seat inside the coned body and create the required seal.

3. Apply a small amount of **Blue Goop** to the **gland nut threads**.
4. Insert the **tubing** into the **body cone**.
5. Screw the **gland nut** into the connection until finger-tight.
6. Finally, tighten the **gland nut** (use two wrenches) to its specified torque value (see Table 6-1).

Description	Torque Value
1/4" tube, coning and threading, 60 Kpsi	25 lb-ft, 34 N·m
3/8" tube, coning and threading, 60 Kpsi	60 lb-ft, 68 N·m
M8 clamp bar screws	10 -12 lb-ft, 13.6 -16.3 N·m

Table 6-1: Torque Values for UHP Fittings

Working with High-Pressure Systems

To properly install and maintain fittings and tubings in high-pressure systems, observe the following:

- **Do** thread the body and tube.
- **Do** observe the correct thread direction when threading the body and tube (body thread – right-handed; tube thread – left-handed).
- **Do** thoroughly clean fitting components prior to assembly. Any dirt or contamination can compromise the metal-to-metal seal, creating a path for the water to escape.
- **Do** apply Blue Goop to lubricate the gland nut threads prior to assembling the fitting. This prevents the metals from galling together and ensures that the fitting can be disassembled later.

Caution: *Applying too much Blue Goop can contaminate or foul other machine components. Applying just the correct amount of Blue Goop to your high-pressure components prevents the stainless steel componts from galling and avoid contamination problems. Apply Blue Goop sparingly.*

- **Do** follow the *Three Thread Rule* (see above).
- **Do** tighten the gland nut to their proper torque specification based upon connection size. Refer to Table 6-1. Fittings will leak if not sufficiently tightened.
- **Do** periodically inspect the UHP tubing and fittings for leaks. A hole in the tubing sprays as a fine mist.
- **Do** replace damaged or leaking components in the UHP fitting. **Always** replace and **never** repair damaged or leaking components. Damaged components generally fail once exposed to high pressure.
- **Don't** over-tighten the gland nut. This could obstruct the end of the tube and restrict flow.
- **Don't** apply a thread-sealer such as Loctite or Teflon tape to UHP fittings. The metal-to-metal contact between the coned tubing angle and the body cone angle creates the high-pressure seal, not the fitting threads.
- **Don't** try to adjust a fitting while still under high pressure. An injury and/or a damaged system component could result.

Tank Maintenance

It's good practice to wash all abrasive particles and grit from exposed JetMachining Center surfaces at the end of each shift or work day. A clean machine lasts longer and requires less maintenance. The OMAX is designed to prevent abrasive from contaminating bearings and other critical parts, but it's also important to keep a clean working area to minimize abrasive exposure to your machine. In general, you should keep the OMAX clean and wiped down by having plenty of sponges available in the machining area and regularly washing down the table surfaces.

Caution: *When washing down the equipment, hold the hose at a distance of at least 18" (46 cm) from the washing surface to prevent possible damage to exposed seals. Air may also be used to blow away grit if the same distance is maintained.*

Cleaning Tips

Keep water away from the controller

Never spray water directly at the controller cabinet, keyboard, or mouse. Wipe down the outside of the controller with a sponge regularly.

Keep the bellows clean

Spray the X, Y and Z-axis bellows as needed to keep them free of abrasive material accumulation. If abrasive particles get inside and onto the bearings, they will no longer function as precision bearings. Check regularly to make sure there are no rips or tears in the bellows. Inspect the bellow cuff and bellow adapters ensuring that everything is properly sealed. Once bellows damaged is detected, repair it immediately. Refer to *Maintaining the X-Y Carriage Bellows*, page 6-9.

Note: OMAX supplies a repair kit for bellows rips and tears, P/N 302393.

Use a splash shield during machining

You can purchase a splash shield from OMAX or construct one yourself from clear plastic.

A splash shield allows you to view the machining process and at the same time keeps the spray inside the tank, which is important in maintaining a clean working area.

Keep material surfaces clean while machining. When cutting thick materials, abrasive particles build up on top of the material. Make sure that you wash off this accumulation. Otherwise, large accumulations of abrasive tend to pile up on the cutting path which can affect machining accuracy.

Clean garnet flows better

Even small particles of paper allowed to mix in with your abrasive material can clog the nozzle, costing downtime and possibly a ruined part. It's much easier to start with clean abrasive and keep it that way.

Caution: *Ensure that your garnet remains dry. Always store it in a location removed and protected from the typical wet, abrasivejet environment. Damp garnet will lump together and not flow properly.*

Check the Tilt-A-Jet bellows daily

If your JetMachining Center uses the Tilt-A-Jet option, keep its bellows clean and check them daily for rips and tears. If a hole develops in one of these bellows and allows garnet in, the precision bearings will suffer. A rip or tear in a Tilt-A-Jet bellows cannot be repaired. Contact your distributor or OMAX Customer Service for replacement.

Removing Garnet Accumulation

Since garnet abrasive and metal particles are constantly accumulating in the tank, a regularly scheduled removal of accumulated deposits is necessary. Usually, when large quantities of abrasive particles quickly settle on the material being machined, it's an excellent indicator that the tank is holding too much abrasive and removal is necessary.

When removing abrasive material from the bottom of the tank, it's best to completely drain water from the tank before attempting to remove the abrasive waste. The drier the abrasive, the easier it shovels out. Using a pointed shovel is probably the most effective way of emptying the tank by hand.

Note: *The OMAX Solids Removal System (SRS) is an effective alternative to manually cleaning the tank. Contact your OMAX sales representative for details.*

Used garnet abrasive by itself is not toxic and may be taken to a dump site or disposed of normally. However, if any hazardous materials were cut, the abrasive waste becomes subject to a number of environmental regulations. Contact your local resources for proper disposal methods.

Solids Removal System Clean Out Software

The Solids Removal System (SRS) system prevents garnet from accumulating in your tank. To keep your SRS running at its best, it's important to run it continuously even when not cutting. Also, twice a week you should run the SRS Sweep Program that's included with your OMAX software. This program stirs up residue that is at the bottom of the tank and distributes the accumulated abrasive evenly throughout. Once the water has been churned up and the abrasive is circulating through the tank, the SRS is able to suck out the excessive material.

The SRS Sweep Program is located on your PC in the OMAX Corporation > OMAX_Layout_and_Make > Samples > Useful_Tools directory. This drawing is written for the size of the 55100 tank, so you should resize the drawing to accommodate the size of your OMAX JetMachining Center. From beginning to end, the sweep process takes about 15 minutes. Run the program twice a week to keep your SRS working at its best.

Cleaning the Filter Screen for the Tank's Water Outlet

Water accumulated in the catcher tank exits through a water outlet filter (Figure 6-3). This filter should be periodically inspected to determine if cleaning the screen is required. This filter screen may be removed for cleaning using a 1.5" open end wrench. Once removed, scrub it clean using a mixture of mild soap and water.

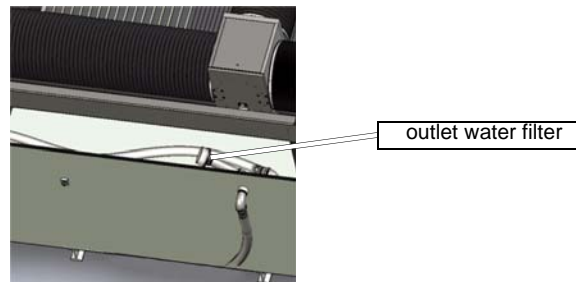

Figure 6-3: Outlet Water Filter Screen at Back of Tank

Controlling Tank Odor

Like any untreated open water in a storage container, the catcher tank can become a home for bacteria growth, creating an offensive odor and infection source for any open wounds. To control bacteria, the JetMachining Center uses anti-bacterial chemicals such as those used in swimming pools or hot tubs that reside in a plastic floating device inside the tank.

WARNING! *Untreated tank water supports bacteria growth that can infect open wounds. Use the bacteria control materials provided with the OMAX odor control kit and keep tank water away from any open wounds by wearing appropriate gloves for protection.*

Periodically check the chemical content inside the floating device. Refer to the instructions included with the anti-bacterial chemicals. The JetMachining Center comes with sufficient chemicals to last approximately one year. When reordering chemicals, use Pace Pool Chlorinating Tablets manufactured by Olin Chemicals, or an equivalent product. If you switch

to a different brand, be sure to read any warning labels. Mixing different brands of chemicals could create a hazardous situation.

Caution: *DO NOT add chlorine tablets when using an EBBCO Closed Loop System to treat your tank water. Chlorine will ruin your filter system. The EBBCO Closed Loop System has its own ozone generator that controls bacteria growth.*

Slat Replacement

In time, table slats can become scored with deep abrasivejet cuts and will be unable to provide the stability and support required for precision cutting. Slats should be inspected for wear at least once a month. Those weakened and worn should always be replaced.

Note: *The working life of a slat can be greatly improved by periodically rotating them to different table locations.*

When replacing a defective slat, also inspect the slat holder for excessive wear. When worn too much, they no longer prevent slats from rocking back and forth which can interfere with cutting precision. Worn slat holders should also be replaced.

New sets of galvanized steel slats can be ordered from OMAX. Stainless steel slats are also available through special order (stainless steel slats are standard on the 2626|xp). It's also possible to cut your own slats using your JetMachining Center. Each slat should be 1/8" (3 mm) thick and 4" (10 cm) tall. To provide a level support surface, ensure that the 4" (10 cm) slat dimension remains within 0.005" (0.1 mm). Make the length equal to the existing slat length.

Maintaining the X-Y Carriage Bellows

The bellows protecting the precision bearings of the X-Y carriages on your OMAX are often overlooked, yet they are vital components of your machine. By shielding the X-Y bearings, the bellows make possible smooth and precise movements of the cutting nozzle. If the bellows or their seals are damaged, operation of the bearings and ball screws can be compromised by the presence grit, water, and other contaminants. Even the smallest tear in the bellows can cause major component damage. The resulting problems can go beyond imprecise cuts: they can even shut down your shop while critical parts of your OMAX are replaced or repaired by your OMAX Customer Service technician.

To keep the X-Y bearings in top-notch condition, regularly inspect the bellows for tears and cracks. Keep the bellows clean and supple using a conditioner such as Armor All® and repair any holes or tears by using the OMAX Bellows Repair Kit (P/N 302393). If the bellows become damaged beyond repair, replace them: you'll save a lot of time and money in the long run by protecting the precision linear bearings and ball screws. In addition to inspecting the exterior condition of the bellows, remove the bellow cuffs from the bellow adapters and look inside.

Caution: *Always clean the outside of the bellows before looking inside to avoid the introduction of grit and dirt into the bearings or ball screws.*

With the bellows open, wipe down and lubricate the rails, bearings, and ball screw nut. Use only Arctic Grease (P/N 304368) and follow the instructions provided in *Lubricating the JetMachining Center*, page 6-14.

Before resealing the bellow cuffs to the bellow adapters, check the condition of the adapter rings. If you find the factory-installed foam backing degraded or see evidence of water intrusion, carefully and completely remove the foam using a razor blade. Before closing and resealing the bellows, apply a generous, continuous bead of silicone sealant (P/N 203339) to the rim of any bellow adapter surfaces where the foam was removed. Put the bellow adapters back on, secured in place with the fastening hardware. Wipe off any excess sealant, leaving behind smooth surfaces for the bellow cuffs to seal against. Use a flashlight to make sure the bellow adapters have sealed against their mating component faces, then reattach the bellows. The silicone sealant will perform as well as the original foam backing material.

By regularly cleaning, conditioning, and repairing the bellows on your OMAX, the precision bearings in your X-Y assemblies can stay dry, clean, and problem-free.

Timing Belt Inspection and Tensioning

Steel-reinforced timing belts are used by JetMachining Center to transmit power from the servo control motors to the ball screws for nozzle movement (Figure 6-4). These belts should not wear out with ordinary use, but must be checked annually as part of your routine maintenance schedule for cracks, tears, and proper tension.

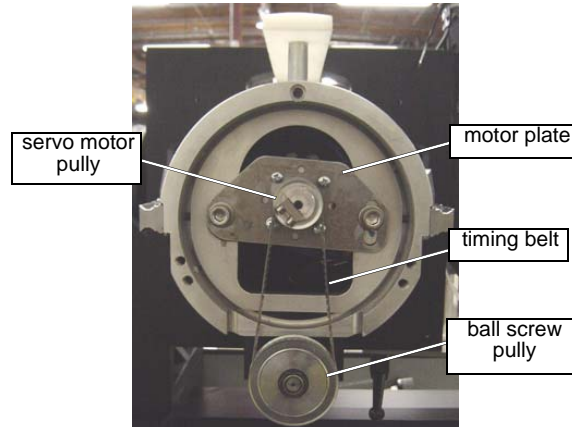

Figure 6-4: Example of Typical OMAX Servo Motor/Ball Screw Timing Belt Connection

Timing Belts for Cantilever Tables

Note: Cantilever tables include the Models 2626, 2626|xp, 2652, 5555, and 55100. OMAX recommends that timing belts for the Model 2626|xp not be removed or adjusted. Doing so could greatly affect its cutting precision. Please contact Customer Service for additional 2626|xp timing belt information.

Locating the Timing Belts

Timing belts connecting the servo motor with the carriage movement ball screws are found at one end of the X and Y-carriages as identified in Figure 6-5:

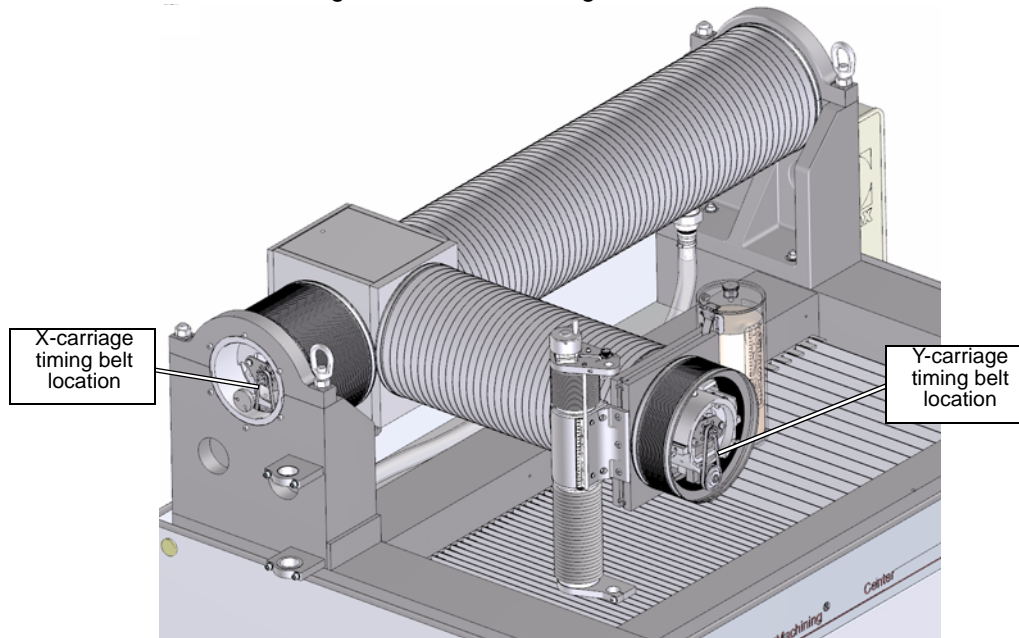

Figure 6-5: Timing Belt Locations Typical of OMAX Cantilever Tables

Inspecting and Adjusting Timing Belts

1. Switch the Main AC Power Switch for the JetMachining Center to OFF.
2. Lock-Out and Tag-Out the Main AC Power Disconnect Switch.
3. Verify that AC power to the OMAX JetMachining Center was properly disconnected.

Caution: *Ensure that both the X and Y-carriage end covers and the adjacent bellows areas are scrubbed clean using soap and water followed by completely drying with towels. Abrasive grit cannot be allowed to enter the carriage mechanisms once the timing belt cover plate is removed.*

4. Expose the timing belt by removing the carriage cover plate. Remove the 6 screws from the X-axis cover plate or the 3 screws from the Y-axis cover plate:

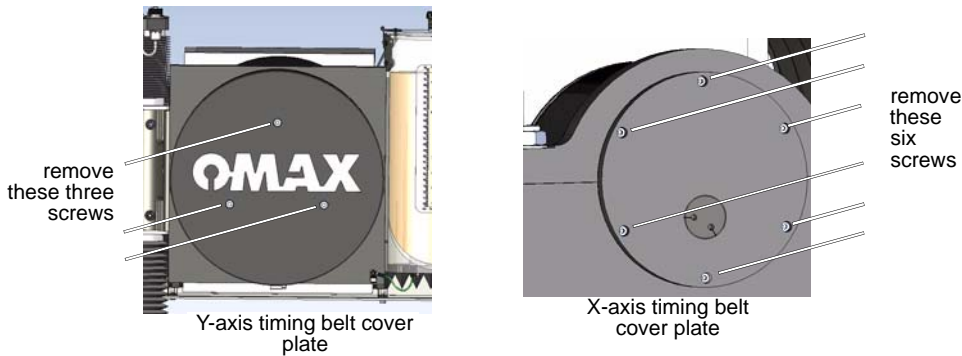

Figure 6-6: Carriage End Cover Screws Removed to Access Timing Belt

5. Set the cover plate and all removed screws aside for safekeeping.
6. Remove each timing belt and inspecting it for tears, cracks, missing teeth, and other defects as follows:
 - a. Loosen the motor plate's pivot screw. Refer to Figure 6-7.
 - b. Loosen the tension adjustment screw.
 - c. To release belt tension, push the motor plate down from directly above the adjustment screw.
 - d. Once tension is released, the belt should lift easily from the pulleys.
 - e. Inspect the timing belt for tears, cracks, missing teeth, and other issues indicating replacement. If defects are noted, replace the belt.

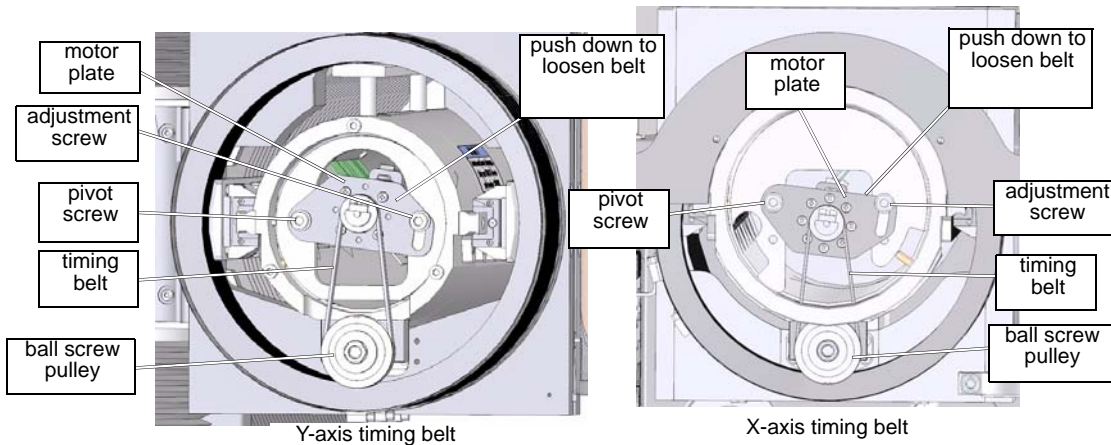

Figure 6-7: Components Involved in Adjusting the Timing Belt Tension

7. Re-install and re-tension the timing belt as follows:

- a. Slip the timing belt over both the upper and lower pulleys.
- b. With both the pivot and adjustment screws loosened, push up on the motor plate with your thumb placed on it directly beneath the tension adjustment screw.
- c. Push hard and hold a steady pressure while tightening the tension adjustment screw.

Caution: *Do not use anything except your thumb to push on the motor plate while tightening. Belts that are over-tightened become noisy during operation. When pressing in on a properly tensioned timing belt, it should deflect approximately 1/8 to 1/4 of an inch (0.30 to 0.64 cm).*

- d. Once the motor plate is securely held in place with the adjustment screw, release thumb pressure and also tighten the pivot screw. Finish by tightening both motor plate screws securely.
- e. Replace the carriage cover plates and screws.

Caution: *When re-installing the X-axis motor cover, ensure that the electrical cables do not come into contact with the drive belt. Eventually, the constant contact with the moving belt could sever the cable.*

Timing Belts for Bridge-style Tables

Y-axis movement for the Bridge tables use the identical servo motor/ball screw configuration as described previously in Timing Belts for Cantilever Tables. Bridge-style tables include the 80X, 60120, and 80160. See Figure 6-8:

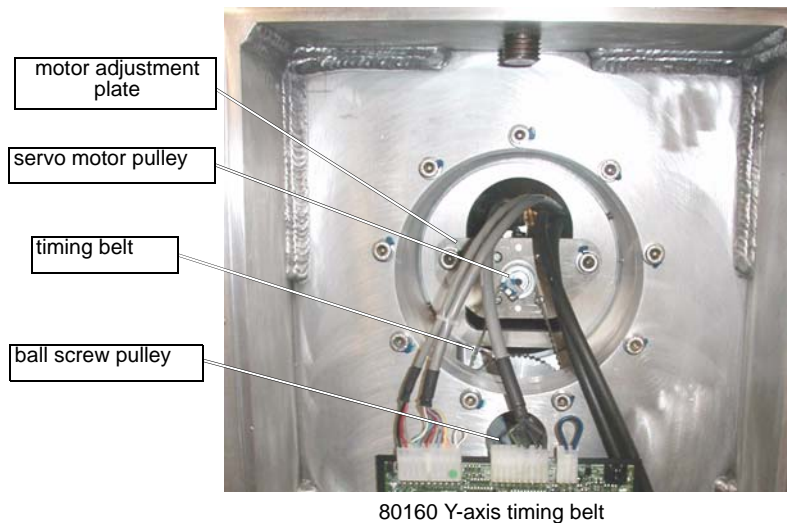

Figure 6-8: Y-axis Servo Motor/Ball Screw Timing Belt Connection for Bridge Tables

Locating the Timing Belts

Timing belt locations for bridge tables are identified in the figure which follows:

Note: X-axis designs for the Models 60120 and 80X use traction drives with linear encoders. These models do not require use of timing belts for X-axis movement.

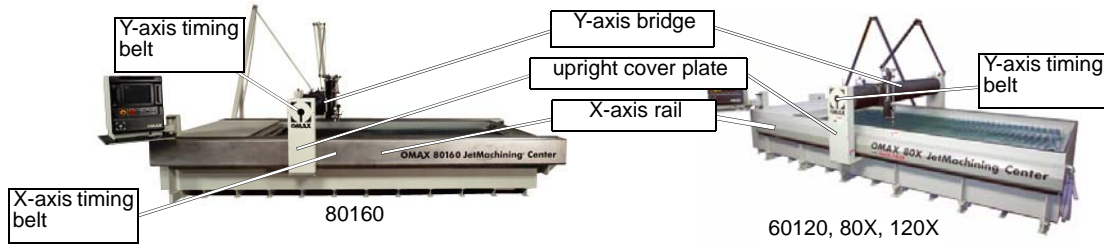

Figure 6-9: Timing Belt Locations for Bridge-style Tables

Adjusting Timing Belts: Y-axis

Timing belt removal and adjustment for bridge tables is identical to the procedures previously provided for cantilever table systems.

1. Switch the Main AC Power Switch for the JetMachining Center to OFF.
2. Lock-Out and Tag-Out the Main AC Power Disconnect Switch.
3. Verify that AC power to the OMAX JetMachining Center was properly disconnected.

Caution: *Ensure that the upright cover plate and surrounding housing are scrubbed clean using soap and water followed by completely drying with towels. Abrasive grit cannot be allowed to enter the carriage mechanisms once the upright cover plate is removed.*

4. Expose the timing belt by removing all screws (10 ea.) holding the upright cover plate.
5. Set the upright cover plate and removed screws aside for safekeeping.
6. Adjust the timing belt following the procedures provided in Inspecting and Adjusting Timing Belts, page 6-11, beginning with step #4a.
7. When complete, replace the upright cover plate.

Adjusting Timing Belts: 80160 X-axis

Note: X-axis designs for the Models 60120 and 80X use traction drives with linear encoders. These models do not require use of timing belts for X-axis movement.

The 80160 uses the standard OMAX servo motor/ball screw design for its X-axis movement (Figure 6-11). Two ball screws are used for X-axis movement, one on each side of the table (Figure 6-9).

1. Locate the timing belt access covers available on both sides of the 80160 frame (Figure 6-10):



Figure 6-10: Remove Cover Plate to Access the 80160 X-axis Timing Belt

Caution: *Ensure that the access cover plates and surrounding frame are scrubbed clean using soap and water followed by completely drying with towels. Abrasive grit cannot be allowed to enter the protected ball screw area once the access cover plates are detached.*

2. From **Make** on the PC-based controller, move the Y-axis assembly down the table until it just reaches the front of the access cover plates. This will position the servo/ball screw assembly alongside the access cover plate, allowing timing belt maintenance when the cover plate is removed.
3. Shutdown **Make** and power OFF the PC-based controller
4. Switch the Main AC Power Switch for the JetMachining Center to OFF.
5. Lock-Out and Tag-Out the Main AC Power Disconnect Switch.
6. Verify that AC power to the OMAX JetMachining Center was properly disconnected.
7. Remove the six screws securing the access covers to the frame. Set the all screws and both access cover plates aside, exposing the ball screws and timing belts (Figure 6-11):

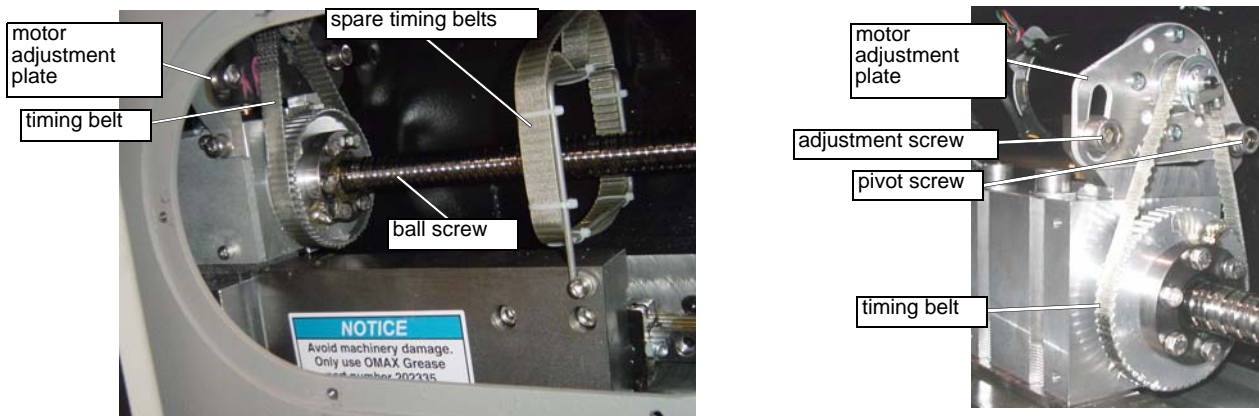

Figure 6-11: View of 80160 Timing Belt With Access Plate Removed

8. Adjust each timing belt following the procedures provided in Inspecting and Adjusting Timing Belts, page 6-11, beginning with step #6a.
9. When inspection and adjustment are complete, replace access covers for both sides.



Lubricating the JetMachining Center

Like all machines, your OMAX requires regular lubrication to keep its moving parts running smoothly and to protect them from drying out. To preserve the life of your system, be sure to lubricate ball screws, ball nuts, linear rails, and the bearings on an annual basis. When lubricating, it is extremely important to use Jet-Lube's Arctic Grease (Anhydrous, calcium 12-hydroxystearate - OMAX P/N 202335) as specified by OMAX due to its superior lubrication qualities and excellent performance over a wide temperature range. While there are many excellent greases commercially available, you cannot be sure that they will be compatible.

Caution: *If the grease used is not compatible with Arctic Grease (or another brand), a chemical reaction can occur that separates both grease types and impairs the lubrication qualities of both. Once this happens, a premature failure of a bearing or associate device is probable. If you have been mixing greases on your ball screws/nuts, X and Y-axis rail bearings, etc., even if you have not had any issues, we highly recommend that you fully purge the mixture of greases with 100% Arctic Grease.*

Grease Fittings and Couplers

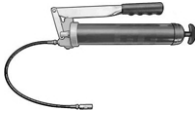
Two different types of grease fittings are current in use on OMAX tables: a standard **zerk** fitting, and a **grease cup** fitting (on Motorized Z-Axis and Tilt-A-Jets only). Refer to the following table for an illustration of each:

Grease Fitting	Required Coupler	Where Used
zerk nipple 	Standard grease gun with zerk coupler (provided with OMAX machine) 	x, y linear bearings, ball screws, and ball screw bearing housings
grease cup 	blunt-tip grease needle (P/N 202633) 	Motorized Z and Tilt-A-Jet linear bearings

Identifying Lubrication Points

Use the following table to identify lubrication points for specific OMAX table models:

Note: *Jet-Lube's Arctic Grease should be used for all lubrication points except for the Motorized Z lead screw bearing (Figure 6-18) which uses 30 weight oil.*

OMAX JetMachining® Center Models	Lubrication Points		Locations
2626, 2626 xp, 2652, 5555, 55100	Y-axis carriage	4 linear bearings 1 ball screw nut 1 ball screw tail bearing	Figure 6-12 Figure 6-13
	X-axis carriage	4 linear bearings 1 ball screw nut 1 ball screw tail bearing	Figure 6-12 Figure 6-13
	X-axis carriage	1 ball screw bearing housing (55100 and 5555)	Figure 6-12 Figure 6-13
80160	Y-axis	4 linear bearings 1 ball screw nut 1 ball screw tail bearing	Figure 6-12 Figure 6-13
	X-axis	2 linear bearings 1 ball screw nut 1 ball screw bearing housing (on each side of the 80160)	Figure 6-20 Figure 6-21 Figure 6-22
60120	Y-axis	4 linear bearings 1 ball screw nut 1 ball screw tail bearing	Figure 6-12 Figure 6-13
	X-axis	lubrication not required	
80X	Y-axis	4 linear bearings 1 ball screw nut 1 ball screw tail bearing	Figure 6-12 Figure 6-13
	X-axis	lubrication not required	
120X	Y-axis	zerk fittings on back of Z-axis housing	Figure 6-23
	X-axis	lubrication not required	
Motorized Z-Axis	Z-axis	4 linear bearings 1 lead screw bronze bearing (30 weight oil)	Figure 6-16 Figure 6-18



Lubrication Points for Cantilever Style X, Y Carriages

Figure 6-12 below identifies lubrication points for the OMAX models 2626, 2626|xp, 2652, 5555, and 55100. All grease fittings on the carriages are zerk style.

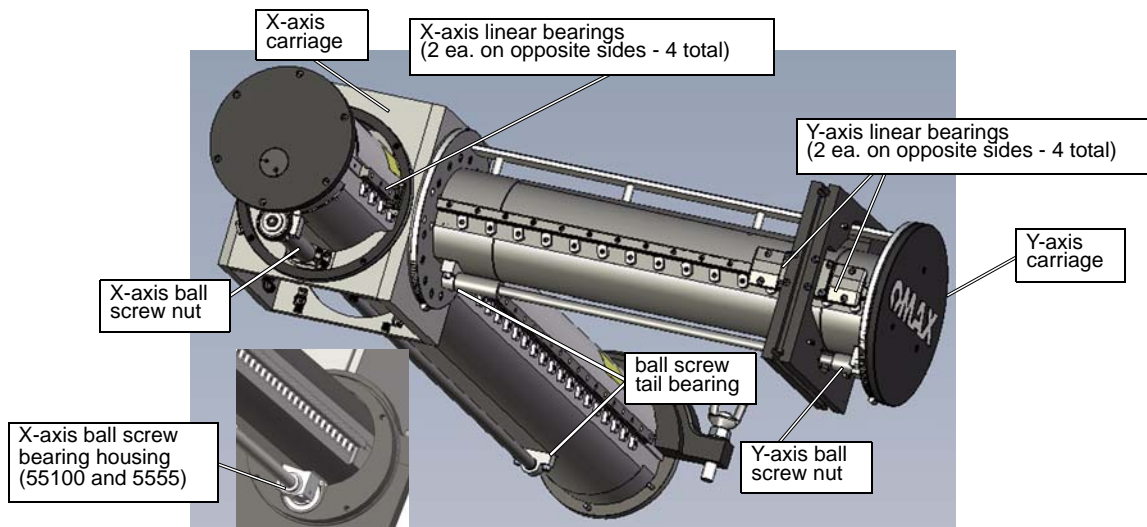

Figure 6-12: Lubrication Points on OMAX Cantilever Style X, Y Carriages

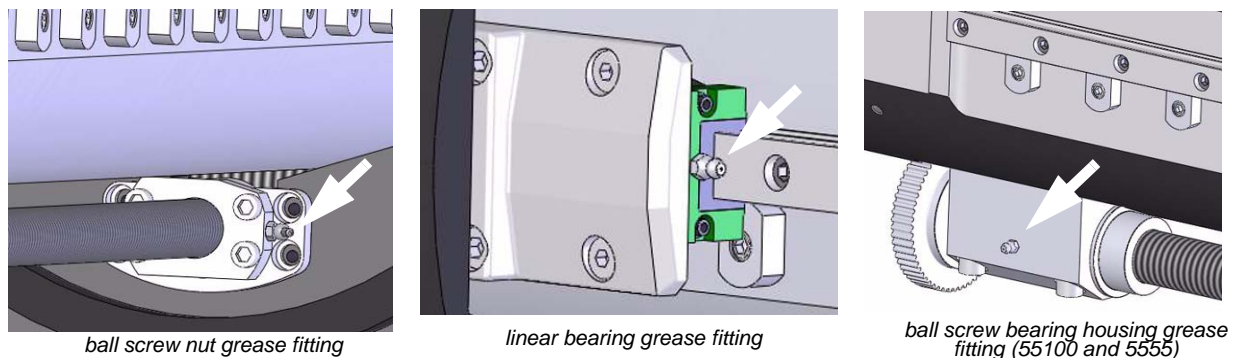

Figure 6-13: Lubrication Fittings for Cantilever Style X, Y Carriages

Greasing the X and Y Carriages

1. Move both the X and Y-carriages to their mid-positions.
2. Using soap and water, clean the bellows on both carriages to remove all abrasive particles and other contaminants. Dry the cleaned bellows with a towel.

Caution: *To prevent abrasive from falling inside the carriages and damaging the bearings, never remove the bellows before they are cleaned thoroughly. Even the smallest amount of abrasive contamination can severely reduce the life of lubricated carriage components.*

3. Loosen the bellow clamp at the end with the timing belt (see Figure 6-8), leaving the bellows attached on the opposite end.
4. Pull the loosened end of the bellows back, exposing the carriage, bearings, and ball screw.

Note: *This is an excellent time to conduct a thorough inspection of the internal carriage components to detect and correct any bellows tears, garnet contamination, worn bearings, pitted bearing track, etc.*

5. Locate the grease fittings on the **ball screw** and the **linear bearings** (Figures 6-12 and 6-13). For a 55100, also locate the ball screw bearing housing.

Note: *It may be necessary to loosen the bellows clamps at both ends of the carriage to access these tail bearings. The ball screw tail bearings do not provide grease fittings. These needle bearings are easily lubricated by forcing grease with your finger into the end of the bearing until grease squeezes out the opposite end.*

6. Pump grease into the carriage fittings until grease begins to squeeze out (at most, requires three strokes with the grease gun). The grease will emerge at some location away from the area of the grease fitting.
7. Slide the bearing assemblies back and forth on the rail at least ten times to distribute the grease adequately on all components. Wipe excess grease from the rails when finished.
8. After sliding the bearing assemblies, again connect the grease gun and pump grease until it begins to squeeze out from under the assembly.
9. Locate and grease the two ball screw tail bearings (Figure 6-12).
10. Replace the bellows after carefully inspecting them for tears or cuts. Before tightening the bellows clamps, ensure that the bellows fully cover the internal carriage components and are not being pinched. Moving the nozzle to compress a stretched bellows will make clamping easier.

Caution: *If tears are noted in a bellows, replace the bellows immediately or repair the tear using the Bellows Repair Kit (OMAX Part #302393). Running the OMAX with an opening in the bellows allows garnet and grit to enter and damage the precision mechanisms, causing serious damage and requiring replacement of the entire assembly. Do not use the OMAX until the bellows are repaired or replaced.*

Lubrication Points for the Motorized Z-Axis

Once a year, the four bearings in the Z-axis require greasing. You do not need to remove the Z-axis to grease these bearings. A fitting extension (blunt tipped grease needle) that couples with standard grease guns is included with your OMAX.

Greasing the Z-axis Bearings

1. Both raise and lower the Z-axis while carefully cleaning the bellows using soap and water to remove all loose garnet and grit.

Note: *Raising and lowering the Z-axis stretches the bellows and allows for a more thorough cleaning. It also makes it easier to remove the bellows.*

2. Carefully inspect the bellows for any tears or rips.

Caution: *If tears are noted, replace the bellows immediately or repair the tear using the Bellows Repair Kit (OMAX Part #302393). Running the OMAX with an opening in the bellows allows garnet and grit to enter and damage the precision mechanisms, causing serious damage and requiring replacement of the entire assembly. Do not use the OMAX until the bellows are repaired or replaced.*

3. Using a 5/16" (8 mm) socket, unscrew the two clamps holding the bellows in place that are identified in Figure 6-14 below:

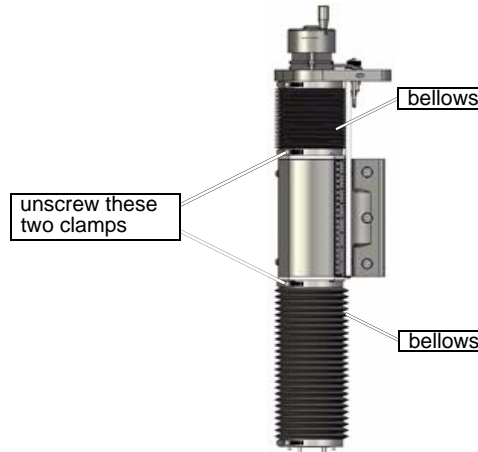

Figure 6-14: Z-axis Assembly

Note: This is an excellent time to conduct a thorough inspection of the internal components to detect and correct any bellows tears, garnet contamination, worn bearings, pitted bearing track, etc.

4. Lift up the bellows to expose the grease points on the Z-axis mechanism.

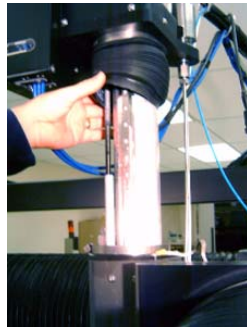

Figure 6-15: Lift Bellows to Expose Grease Points

5. There are four bearings in the Z-axis housing that require lubrication using Jet-Lube's Arctic Grease - OMAX P/N 202335 (see Figure 6-16).

Note: It is not necessary to remove the Z-axis to lubricate these bearings. The figure below shows a disassembled Z-axis for clarity.

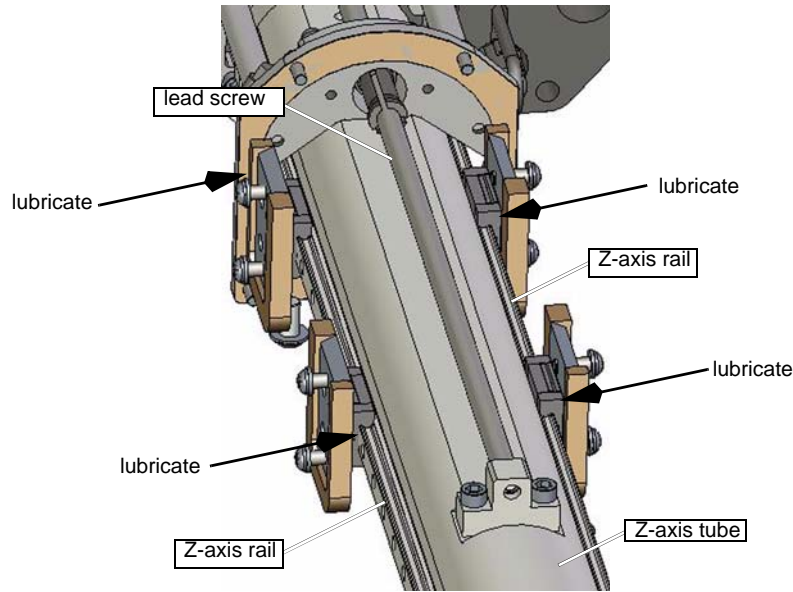

Figure 6-16: Z-axis Bearing Locations Requiring Lubrication

6. Attach the blunt-tip needle extension (P/N 202633) to the grease gun to lubricate each of the four bearing assemblies. There is a small grease cup at the end of the bearing that this needle extension fits against.

Note: In the following figure, the bellows adapter plate has been removed for picture clarity. It is not necessary to remove this part to lubricate the Z-axis bearings.

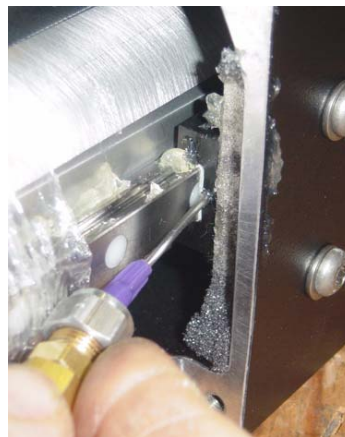

Figure 6-17: Use the Blunt-tip Grease Needle to Lubricate the Four Z-axis Bearings

Note: Using a flashlight makes it easier to locate each bearing and grease cup.

7. Once greased, slide the bearing assemblies up and down the rail at least ten times to distribute the grease adequately on all components.
8. After sliding the bearing assemblies, again add grease to the four Z-axis bearing assemblies.
9. Remove the top Z-axis bellows clamp and drop down the bellows to expose the lead screw bearing (Figure 6-18):

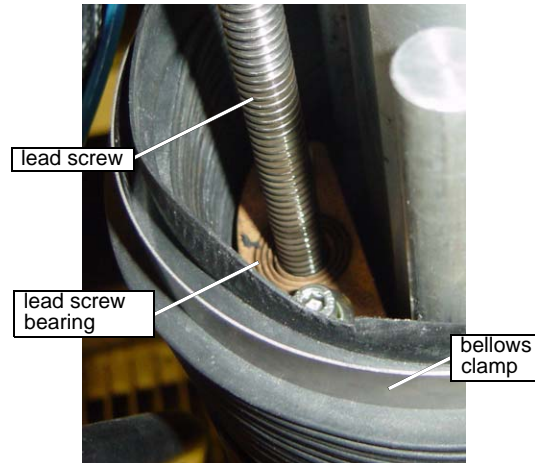

Figure 6-18: Motorized Z Lead Screw Bearing Location

10. Place at least two drops of 30 weight oil onto the grooved part of the lead screw bearing surface.
11. Following lubrication of all five motorized Z bearings, reclamp both ends of the bellows to the Z-axis by raising the Z-axis as high as possible, making reclamping easier. Tighten the clamp, ensuring that it holds the bellows securely in place and verify that the bellows is not being pinched.
12. Once the bellow is clamped in place, run the Z-axis all the way up and down a few times to distribute the lubrication all along the screw and rails.

Lubrication Points for Bridge Style X, Y Carriages

The bridge style JetMachining Centers include the OMAX models 80160, 60120, 80X, and 120X. Ball screw drives are used for both the 80160 X and Y carriages, but are used only for the Y carriage on the 60120 and 80X machines. The ball screws and bearings must be greased and inspected at least once per year.

Intelli-TRAX traction drives are used on the X carriages for both the 60120 and 80X machines and do not require lubrication (refer to **Identifying Lubrication Points** on page 6-15). The 120X uses traction drives for both its X and Y carriages. The X carriage for the 120X does not require lubrication, but its Y carriage must be periodically lubricated (see Lubricating the X-axis Rails for the 120X on page 6-23 for instructions).

Lubricating the Y-axis Carriages for the 80160, 60120 and 80X

Note: Refer to Lubricating the X-axis Rails for the 120X on page 6-23 for instructions on lubricating the 120X Y-axis carriage.

1. Move the Y-axis to its mid-position; move the X-axis to its Home position.
2. At this time, carefully inspect each bellows for any tears or cuts.

Caution: *If tears are noted, replace the bellows immediately or repair the tear using the Bellows Repair Kit (OMAX Part #302393). Running the OMAX with an opening in the bellows allows garnet and grit to enter and damage the precision mechanisms, causing serious damage to the entire assembly. Do not use the OMAX until torn bellows are repaired or replaced.*

3. Clean the bellows with soap and water. Dry the bellows with a towel.

Caution: *To prevent grit from getting inside and damaging critical components, never open the bellows until they are thoroughly cleaned and dried.*

4. Loosen the bellows clamp on the Y-axis carriage. Leave the bellows attached on the other end.

5. Pull the loosened bellows back, exposing the four linear bearings and the ball screw nut (refer to Figure 6-13).

Note: *This is also an excellent time to conduct a thorough inspection of the internal components to detect and correct any bellows tears, garnet contamination, worn bearings, pitted bearing track, etc.*

6. Attach the grease gun to the zerk fittings and pump grease (three strokes at the most) into each lubrication point (four linear bearings, two ball screw nuts, two bearing housings) until they fill and the grease just begins to emerge.
7. Slide the bearing assemblies back and forth on the rail a few times to distribute the grease adequately on all components. Wipe excess grease from the rails when finished.
8. Locate and grease the ball screw tail bearing at the end of the Y-axis ball screw (Figure 6-12).

Note: *It may be necessary to also loosen the bellows clamps at both ends of the carriage to access these tail bearings. The ball screw tail bearing does not provide a grease fitting. These needle bearings are easily lubricated by forcing grease with your finger into the end of the bearing until grease squeezes out the opposite end.*

9. Inspect the bellows adapter ring for any signs of water intrusion inside the bellows. If leakage is detected, refer to *Maintaining the X-Y Carriage Bellows* on page 6-9 for repair instructions.
10. Replace the bellows after carefully inspecting them for tears or cuts. Before tightening the bellows clamps, ensure that the bellows fully cover the internal carriage components and are not being pinched. Moving the nozzle to compress a stretched bellows will make clamping easier.
11. When finished greasing, slide the bellows back over the carriage components, reinstall and retighten each bellows clamp.

Lubricating the 80160 X-axis Rails

Note: *The X-axis traction drives for the 60120, 80X, and 120X do not require lubrication.*

1. Remove the oval access covers from both sides of the 80160. Set the 6 removed screws and cover aside for safekeeping.



Figure 6-19: Remove 80160 Access Covers to Reach Rail Lubrication Points

Note: *Inside the rail covers and on each side of the tank are two linear bearing grease fittings, one ball nut grease fitting, and one ball nut bearing box grease fitting. To access these fittings, it is necessary to move the Y-axis until each fitting is positioned in front of the oval access hole.*

2. Position the Y-axis until the ball screw nut appears inside the oval access hole (Figure 6-20):

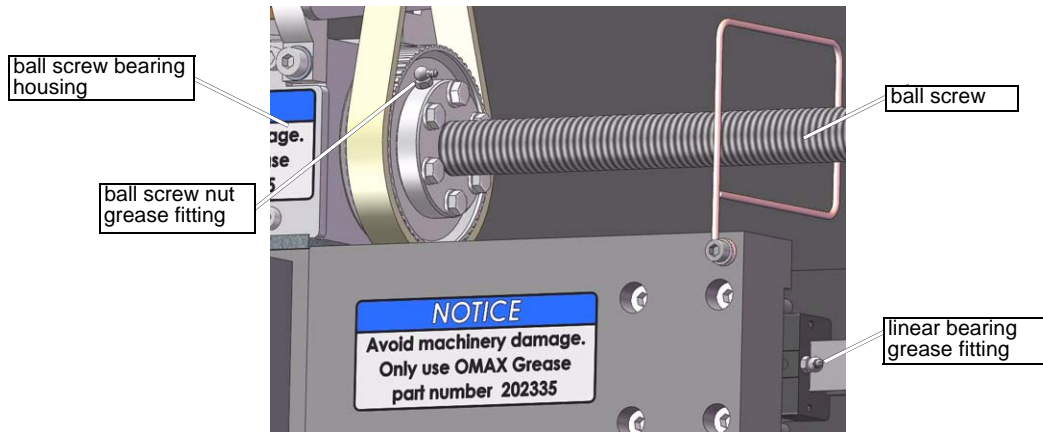

Figure 6-20: Grease Fittings for the 80160 Ball Screw Bearing Housing and Linear Bearing

3. Pump grease into each fitting until grease begins to emerge from each bearing (at most three strokes with the grease gun). Repeat this for the same bearings on the opposite side of the tank.

Note: The ball screw nut provides a zerk grease fitting; the linear bearing provides the flush style grease fitting.

4. Again, move the Y-carriage until the other end of the ball screw bearing housing (Figure 6-20) is positioned in front of the access window with its zerk grease fitting accessible (Figure 6-22).

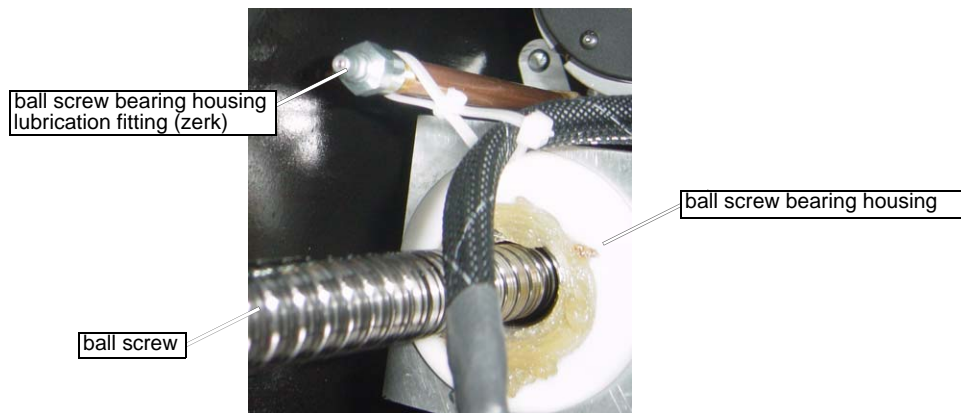

Figure 6-21: Grease Fitting for Lubricating the X-axis Ball Screw Bearing Housing

5. Pump grease into this fitting as described earlier; repeat this for the same fitting on the opposite side of the tank.

Note: It is normal to see large amounts of grease on the outside of the ball screw bearing housing.

6. Locate the second linear bearing for the X-axis rail (Figure 6-22) and grease it appropriately. Repeat this for the same bearings on the opposite side of the tank.

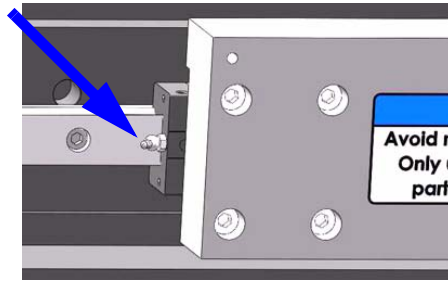

Figure 6-22: Grease Fitting for Lubricating the 2nd X-axis Linear Bearing

7. After applying the grease to all the 80160 X-axis grease fittings, move the Y-carriage along the 80160 rail for the full length of the machine at about 25" (64 cm) per minute to distribute the grease along the rail
8. Complete the X-axis lubrication process by replacing each oval access plate.

Lubricating the X-axis Rails for the 120X

Note: It is not necessary to remove the bellows to lubricate the 120X Y-axis carriage. Easily accessible zerk fittings are available for Y-axis lubrication.

1. Position the nozzle to allow easy access to the back side of the Z-axis.
2. Locate and remove the access cover to the Y-axis grease fittings (Figure 6-23).

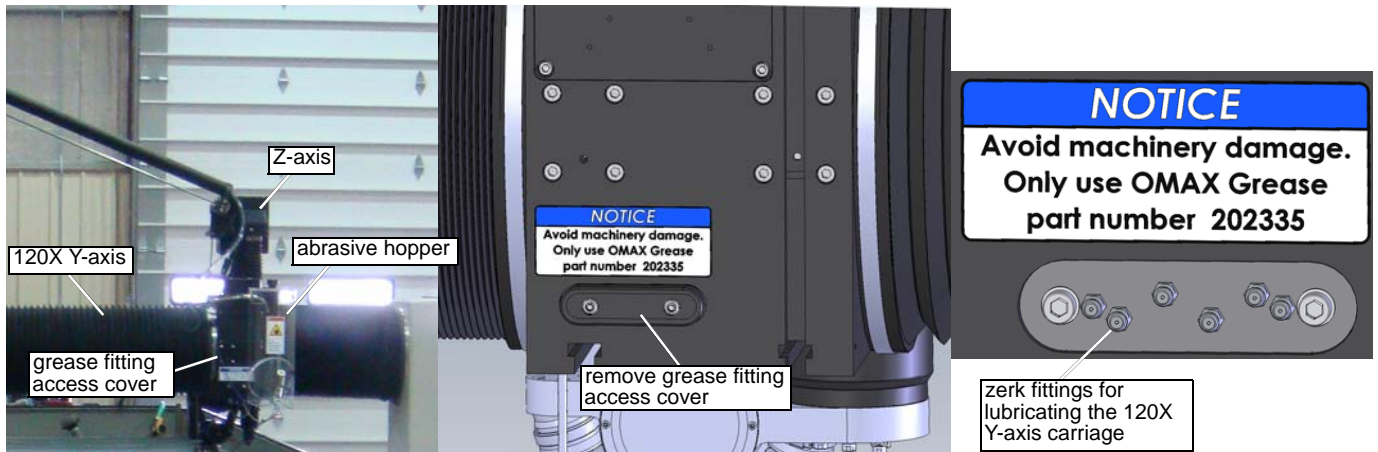

Figure 6-23: The 120X Y-axis lubrication fittings

3. Use a clean rag to wipe off each zerk fitting, removing any old grease, dirt, garnet, etc.
4. Attach the grease gun containing OMAX grease, P/N 202335, and inject up to 4 pumps of grease in each fitting.
5. Move the nozzle all the way across and back the entire Y carriage range ten times to distribute the grease adequately.
6. Lubricate each zerk fitting a second time.
7. Wipe off any excess grease from the fittings and reinstall the access cover.

Rebuilding the Abrasivejet Nozzle

Correct operation of the nozzle assembly is critical for cutting accuracy. Damaged or worn nozzle parts, parts assembled incorrectly, or grit and dirt in the nozzle can adversely impact the nozzle's cutting accuracy, pressure, and operating costs. These rebuild procedures do not discuss the integrated MaxJet 5i nozzle assembly which is designed to be non-repairable with replacement only.

Note: *The nozzle assembly includes all the parts from the inlet body to the tip of the nozzle mixing tube.*

Refer to the nozzle configuration documentation provided with your OMAX JetMachining Center. These documents contain part numbers needed for ordering replacement or spare parts.

Identifying When to Repair and Rebuild the Nozzle

Nozzle assembly use affects these consumable components:

- Nozzle Filter Seal Assembly including the O-ring
- Mixing Tube
- Mixing Chamber Disc
- Mixing Chamber
- Orifice Assembly including the Jewel
- O-rings
- Mixing Tube Nut
- Inlet Body

Indications that nozzle repair is needed:

- Water leaks out of the nozzle assembly weep hole.
- The jet stream is not well formed.
- Cutting quality and accuracy is degraded or reduced.
- Errors occur when cutting round holes or other dimensional objects.
- Cuts are skipped, or no cutting at all.
- Abrasive flow slows or stops.
- Water and abrasive back up through the feed tube and cutting stops.

Preparing for Nozzle Repair/rebuild

Prior to working on the OMAX nozzle assembly, assemble the required tools and documentation as specified in **Tools Required for Table Maintenance** on page 6-3.

Note: *Refer to the applicable Nozzle Assembly Drawing for specific OMAX tool part numbers.*

After preparing your work space and obtaining the necessary nozzle documentation and tools, prepare the OMAX machine for nozzle removal as follows:

1. Clean or rinse off the **cutting head**, including the **nozzle assembly**, to remove any debris or possible contamination.

Caution: *It is extremely important to maintain a high level of cleanliness when working with your nozzle assembly. Even a small piece of garnet or other foreign body can severely impact nozzle performance.*

2. Raise the Z-axis to a height that allows the **nozzle assembly** to be accessed and easily removed.
3. Move the **nozzle head** to an X-Y position convenient for **nozzle assembly** removal.
4. Shut down the applications on the PC-based controller by following proper shutdown procedures.
5. Power OFF the **PC-based controller**.
6. Power OFF the OMAX **pump**.
7. Switch OFF the main AC power, air, and water sources to the machine. Tag and lock them out according to established safety practices. Follow all other company-specified safety procedures.

Removing a MaxJet® 5 Nozzle Assembly from a Tilt-A-Jet

There are eight basic steps for disassembling a MaxJet 5 Nozzle Assembly on a Tilt-A-Jet:

- Step **One**: Remove the **nozzle mixing tube** (see page 6-25)
- Step **Two**: Remove the **nozzle body** from the **inlet body** (see page 6-26)
- Step **Three**: Remove the **filter seal assembly** from the **inlet body** (see page 6-26)
- Step **Four**: Remove the **orifice assembly** (see page 6-27)
- Step **Five**: Remove the **mixing chamber disc** (see page 6-27)
- Step **Six**: Remove the **mixing chamber** (see page 6-27)
- Step **Seven**: Clean the **nozzle** components (see page 6-28)
- Step **Eight**: Inspect the **nozzle** components (see page 6-28)

Note: Although a number of steps are involved in the nozzle rebuild process, it generally takes approximately 15-20 minutes to remove, inspect, and clean a Nozzle Assembly.

Removing the Nozzle Mixing Tube

1. Remove the **abrasive hose** from the **nozzle**.

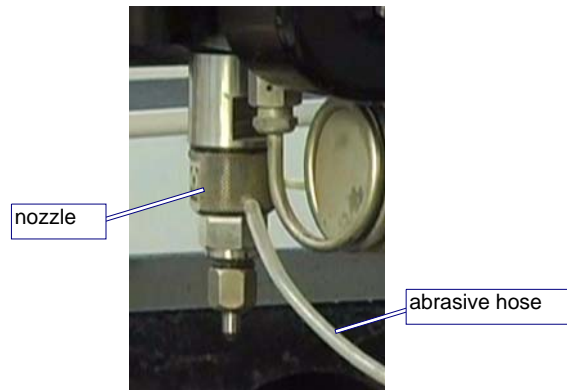

Figure 6-24: Remove the Abrasive Hose from the Nozzle

2. Place a piece of **cardboard** or equivalent blocking material directly under the **nozzle** to prevent any dropped parts or tools from falling into the tank during servicing.
3. Remove the **nozzle mixing tube**:
 - a. Place a **1" open-end wrench** on the **nozzle body** to counteract any torque while loosening the **mixing tube locking nut** (Figure 6-25).
 - b. Loosen the **mixing tube locking nut** using an **11/16" open-end wrench**. When loose, hold the **mixing tube** with your fingers to prevent it from dropping while unscrewing it.

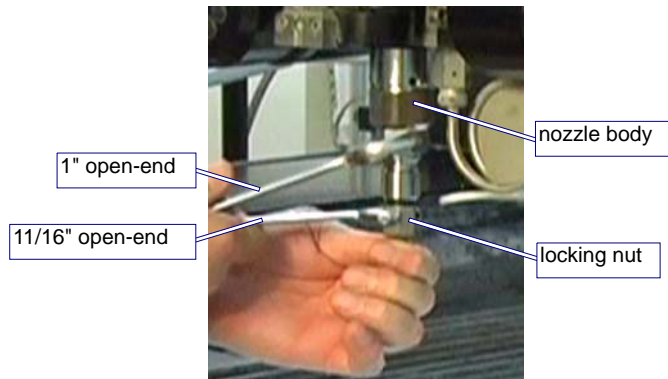

Figure 6-25: Removing the Nozzle Mixing Tube

- c. Remove the **mixing tube** along with the **locking nut** and **collet**. Carefully place all parts on your working area for later cleaning and inspection.

Caution: *The mixing tube, even though it is made from abrasive resistant material, will break if dropped or struck hard.*

Removing the Nozzle Body from the Inlet Body

1. Place a **1/2" wrench** on the upper hex portion of the **inlet body** located at the top of the **nozzle assembly**. This will hold the **inlet body** in place when removing the **nozzle body** and counteract any induced torque that can alter the Tilt-A-Jet's alignment and accuracy.
2. Using a **1" open-end wrench** placed on the **nozzle body**, loosen the right-hand threaded **nozzle body** from the **inlet body** using both wrenches.

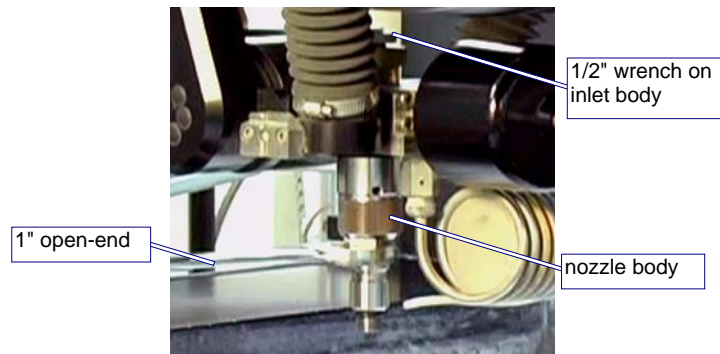

Figure 6-26: Removing the Nozzle Body from the Inlet Body

3. Unscrew the loosened **nozzle body** by hand and place in your working area for cleaning and disassembly.

Removing the Filter Seal Assembly from the Inlet Body

1. Screw the **filter seal assembly removal tool** up into the **filter seal assembly**.

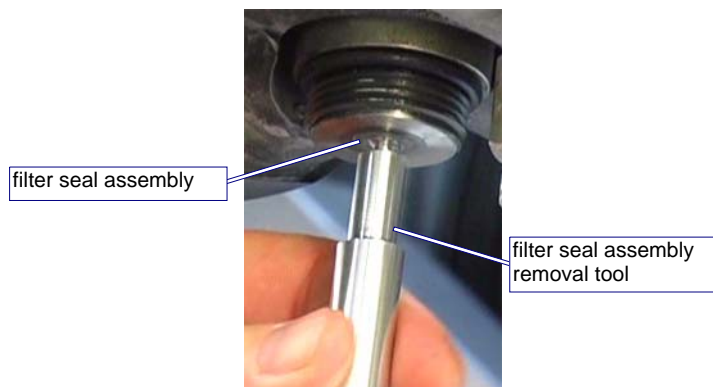

Figure 6-27: Screwing the Removal Tool into the Filter Seal

2. Pull the **removal tool** straight down to remove the **filter seal assembly** from the **inlet body**.
3. Unscrew the removed **filter seal assembly** from the **removal tool** and discard it. The filter seal assembly is a consumable item and will be replaced.

Removing the Orifice Assembly

Carefully remove the **orifice assembly** from the **nozzle body** onto your working surface for later cleaning and inspection.

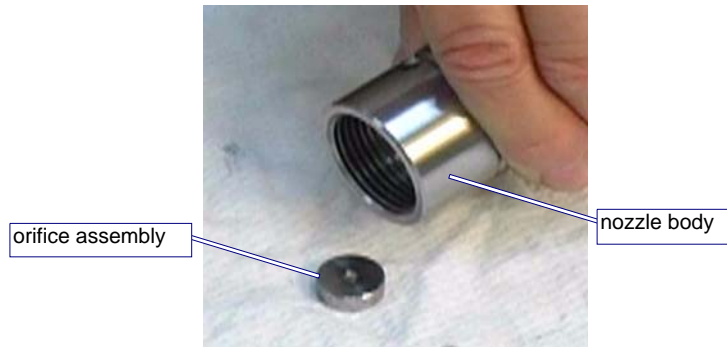

Figure 6-28: Removing the Orifice Assembly from the Nozzle Body

Removing the Mixing Chamber Disc

The **mixing chamber disc** sits directly beneath the **orifice assembly**. To remove the **mixing chamber disc**, gently strike the **nozzle body** onto the palm of your hand, forcing the **disc** to release from the **nozzle body**.

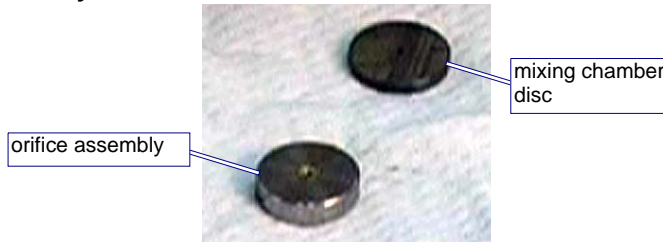

Figure 6-29: Removed Orifice Assembly and Mixing Chamber Disc

Note: If the mixing chamber disc does not easily fall out of the nozzle body, carefully blow compressed air into the abrasive inlet, ensuring that the disc will fall out into your hand or onto a soft surface to avoid cracking or breaking. If compressed air does not remove the disc, carefully push down on the disc from the mixing tube end of the nozzle body using a 3/16" Allen wrench or similar device suitable for pushing.

Removing the Mixing Chamber

The mixing chamber is an infrequent wear item.

1. Inspect the **mixing chamber** prior to removing it.
2. If the **mixing chamber** needs to be replaced, clean the area above the chamber.
3. Press the **mixing chamber** out of the **nozzle body** using the **arbor press** and a push tool.

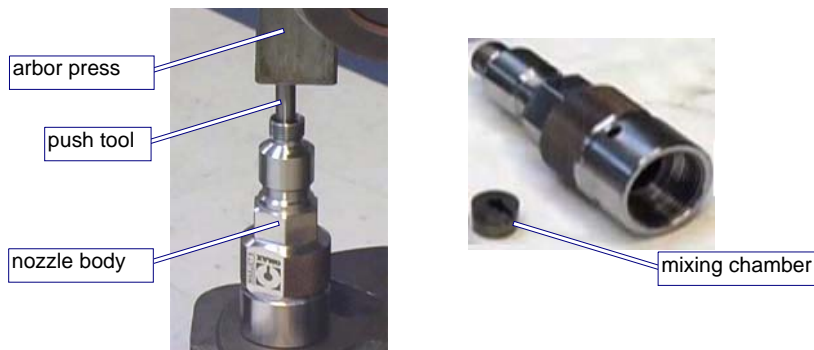

Figure 6-30: Pressing the Mixing Chamber from the Nozzle Body

Note: To facilitate removal of the mixing chamber, it may be necessary to heat the nozzle body using either a heat gun, boiling water, or similar heating technique. It will not be necessary to remove the inlet body from the machine unless leakage is noted in this area.

Removing the Nozzle Body O-Ring

O-rings should be removed for inspection and replaced during the nozzle rebuild when necessary.

1. Remove the **o-ring** from the **nozzle body**.



Figure 6-31: Removing the O-ring from the Nozzle Body

2. This **o-ring** is a consumable item and should be replaced when necessary.

Cleaning and Inspecting Nozzle Components

Cleaning

Cleaning nozzle assembly components and maintaining cleanliness is critical when reassembling nozzle components. Any contamination, such as particles of garnet, metal chips, or small pieces of paper can negatively impact cutting.

1. Make sure your work space is kept clean and free of contamination and your hands are clean prior to handling clean nozzle components. In general, you should wash all parts using a non-abrasive, mild soap with water, or use an ultrasonic cleaner.

Note: A small ultrasonic cleaner containing white vinegar is useful in cleaning nozzle parts and is recommended for removing material buildup in the orifice or jewel assembly.

2. Ensure that dirt and grit are removed from all nozzle parts.
3. Rinse each part using clean water and carefully blow dry.



Figure 6-32: Rinsing Parts with Clean Water

4. Place the cleaned components onto a clean working space for later inspection.

5. Clean the **orifice or jewel assembly** using an **ultrasonic cleaner** filled with **white vinegar**.



Figure 6-33: Cleaning Parts in Ultrasonic Cleaner with White Vinegar

Caution: Use of any damaged or defective nozzle component will negatively impact performance of your OMAX abrasivejet.

Inspecting

There are four primary nozzle assembly components that should be inspected for wear or damage:

- Orifice or jewel assembly
- Mixing chamber disc
- Mixing chamber
- Mixing tube

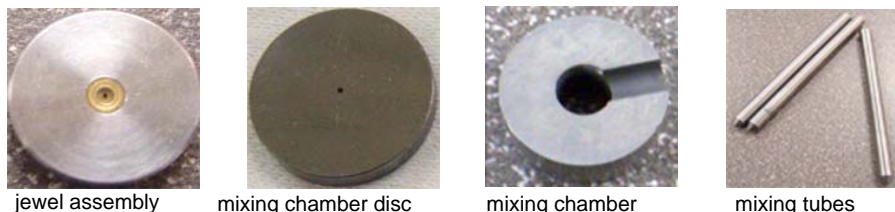

Figure 6-34: The Four Primary Nozzle Assembly Components Requiring Inspection

Carefully inspect any nozzle component that shows signs of water leakage. Some cracks may be extremely fine and not easily detected.

Orifice or Jewel Assembly

The orifice assembly (Figure 6-34), which contains the jewel, is a consumable item that requires inspecting, cleaning, and replacing if damaged. The hole in the jewel is very small, approximately 0.014" (0.36 mm) in diameter for the MAXJET 5 orifice assembly and 0.010" (0.254 mm) in a MiniJet orifice assembly. Water travelling through the orifice is accelerated to extremely high speeds. The jewel may have a small chip or mineral buildup that is difficult to see with the naked eye. The jewel can also be plugged, cracked, worn, or misaligned.

In Figure 6-35, "Good Jewel Orifice", note that the edges are clean and sharp and the center hole is completely round. No cracks or chips appear in the area around the hole, and no deposits are plugging the hole.

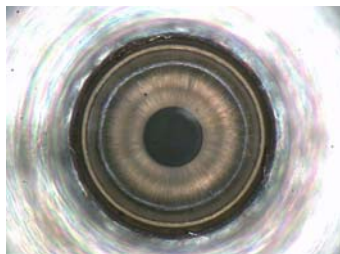

Figure 6-35: Good Jewel Orifice

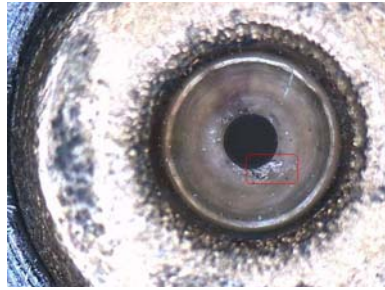

Figure 6-36: Chipped Orifice Assembly Jewel

Particles of debris traveling at high speeds through the orifice can easily chip or damage the jewel by hitting an edge of the orifice.

Variables including elevated water temperature and pH, plus the presence of scaling ions such as calcium, magnesium, or silicon. Ions can cause scale to build up in and around the internal diameter of the orifice. Mineral deposits, or scale, in the internal diameter of the orifice can form a hollow cone surrounding the small hole in the center of the jewel. Eventually, this buildup results in poor jet quality.

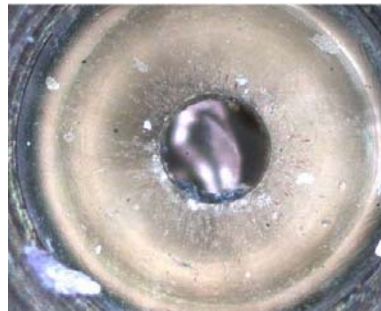

Figure 6-37: Plugged Jewel Orifice

If in-line filters are not used, particles that are too large to pass through the orifice will plug or damage it, causing the pump to fault. A fine particle filter, called the “last chance filter,” is installed just before the orifice to prevent particles upstream in the high-pressure system from entering the orifice.

A misaligned jet stream is one that cannot pass through the mixing tube without touching the inside bore when run at low pressure. Garnet, grit, dirt, or other contamination trapped between the orifice mount and the carbide disc, or between the disc and the carbide mixing chamber, can throw the jet out of alignment, causing premature wear on the mixing tube.

If a jewel is damaged, misaligned, or not producing a well-formed jet, the life of the mixing chamber disc and the mixing tube will be dramatically reduced. If orifice chipping is a chronic problem and not corrected by using filters or following proper procedures, consider using a diamond orifice assembly. Diamond orifices are highly resistant to chipping from particle impact and have a much longer wear life. Additional jewels may be purchased from OMAX's Customer Service.

Mixing Chamber Disc

The mixing chamber disc (Figure 6-34) is also a consumable item requiring close inspection. Magnification may be needed to accurately detect wear or disc damage. Begin by measuring the internal diameter of the hole in the mixing chamber disk using a 0.26" (6.6 mm) pin gauge. The internal diameter of this hole for a new mixing chamber disc is 0.030" (0.76 mm). To inspect the disc, measure the internal diameter of the hole in the mixing chamber disc using a pin gauge. If the internal hole diameter is **greater than** 0.060" to 0.070" (1.52 mm to 1.78 mm), the disc should be replaced.

As the hole in the mixing chamber disc wears, the probability that garnet can travel above the orifice increases, resulting in a chipped orifice. When a mixing chamber hole is no longer round, it indicates uneven wear. Figure 6-38 provides examples of worn mixing chamber discs.

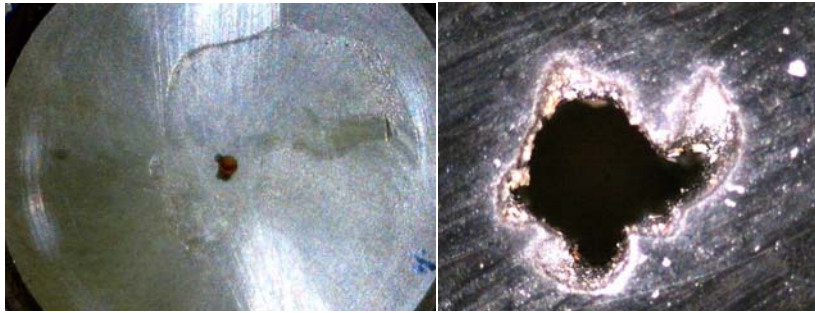

Figure 6-38: Worn Mixing Chamber Discs

When the wear pattern is 'star shaped', it generally means the orifice or jewel is chipped. This star pattern develops because the chip is on the edge of the jewel where the jet is formed, resulting in a small segment of the jet shooting off at a fairly large angle to the opposite side of the jet from where the chip is located. Multiple chips cause multiple segments of the jet to shoot off to different locations around the edge of the jewel and erode the star shaped hole.

Erosion or a wear pattern that prevents the mixing chamber disc from seating flat on the mixing chamber leads to a misaligned jet, causing wear on the mixing tube. Erosion on the bottom surface of the mixing chamber disc may weaken the disc, leading to eventual cracking.

Mixing Tube

Although the mixing tube (Figure 6-34) is made from an extremely hard material, over time, the flow of high-pressure water and abrasive will wear away the inside of the mixing tube. This results in a gradual, irregular widening of the internal diameter of the mixing tube, causing a less accurate stream of abrasive and water. Figure 6-39 provides some examples of worn mixing tubes. A cross section of these mixing tubes reveals the irregular wear of their internal diameter.

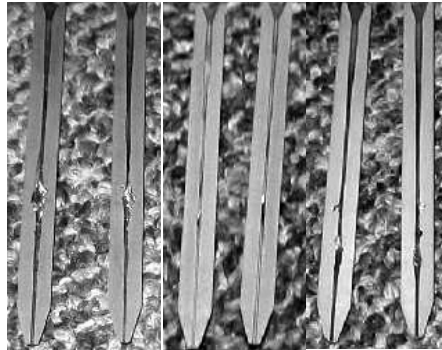

Figure 6-39: Worn Mixing Tubes

The mixing tube is also very brittle and easily broken if dropped or struck hard. The key to a long mixing tube life is maintaining a healthy orifice or jewel. Damage to mixing tubes caused by misaligned jets or a chipped jewel is not apparent when looking through the bore of the mixing tube. The size of the kerf and cutting performance are the best indicators of mixing tube wear. The kerf is the width of the cut made by the abrasivejet. It can range from 0.015" (0.38 mm) to 0.060" (1.52 mm), depending on the nozzle, the thickness of the material being cut, and the amount of wear on the mixing tube.

A clogged mixing tube is most frequently caused by using contaminated abrasive. Because the opening in the mixing tube is small, 0.030" (0.76 mm) on a MaxJet 5 and 0.021" (0.53 mm) on a MiniJet, even a small particle of dirt can clog it. Other potential causes of clogging include contaminated or wet abrasive. Metal chips from other shop operations and paper from the abrasive bag are two common sources of

contamination. Clean the mixing tube and inspect its inlet and outlet ends to see if it needs to be replaced.

If the mixing tube is clogged, try to dislodge the blockage as follows:

1. From OMAX's **Make** software, click the **Test** button to display the *Test Pump and Nozzle* options:

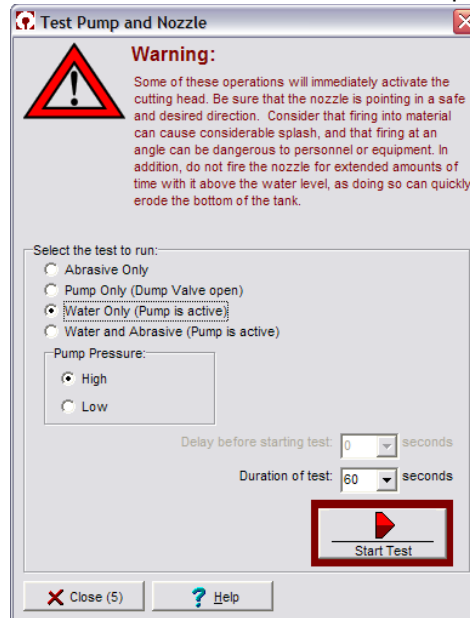

Figure 6-40: Pump and Nozzle Test Options

2. Select **High** for Pump Pressure, check **Water only (pump is active)**, then click **Start Test** to begin the jet stream.
3. Try turning the water only test ON and OFF a number of times in an attempt to dislodge the clog.
4. If that does not work, shut down the machine by following all required power shutdown and safety procedures.
5. Remove the **mixing tube** from the **abrasivejet nozzle**, turn it upside down, and tighten it in the **nozzle body**.
6. Start up the **JetMachining Center**.
7. Again, click the **Start Test** button and repeat the **Water** only test to try and dislodge the clogged material.



Figure 6-41: Installing the Mixing Tube Upside Down to Dislodge a Clogged Opening

Nozzle Filter Seal Assembly

The nozzle filter is a consumable item that should be discarded and replaced each time you replace the orifice or disassemble the nozzle for maintenance. See Figure 6-44 for a filter example.

Mixing Chamber

The mixing chamber is an infrequent consumable item but may need to be replaced if the internal diameter of the mixing chamber hole has grown larger than 0.026" (0.66 mm) or if it shows excessive oblong wear.

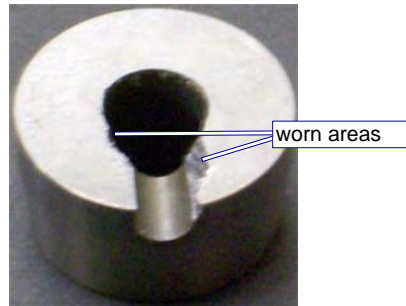

Figure 6-42: Worn Mixing Chamber

Reassembling the Nozzle Assembly

1. After cleaning, inspecting, and obtaining replacement **nozzle components**, you are ready to reassemble the **nozzle assembly** and re-install it on the machine.
2. Purge the **high-pressure plumbing** to flush out any particles or contamination using the **nozzle test** with the **Water** only, **Low**-pressure options (see Figure 6-40 for test menu). To correctly flush your plumbing system, refer to the OMAX document, "Pulse/Surge Flushing of the UHP System", P/N 400571B. This document can be downloaded from the OMAX web site in the Customer Service/Field Technician section at www.omax.com.



Figure 6-43: Purging the High-pressure System of Contaminates with the Nozzle Removed

Caution: *Make sure you maintain cleanliness throughout the nozzle reassembly and installation process. Any contamination that gets into the nozzle components during reassembly will negatively impact the cutting performance and shorten the life of the nozzle components.*

Nozzle Filter Seal Assembly

1. Apply a light coating of **Lubriplate** to the filter's **o-ring**.

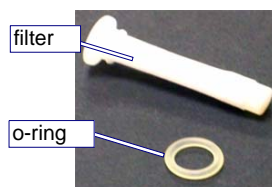

Figure 6-44: Nozzle Filter Seal Assembly

2. Slide the lubricated **o-ring** onto the **filter**.

3. Push the **filter with o-ring** installed up into the **inlet body**.



Figure 6-45: Filter Seal Assembly Inserted into Inlet Body

Note: The nozzle filter seal assembly will be properly seated when the nozzle body is tightened.

Mixing Chamber

1. Place a small dab of **extreme pressure lube** onto a finger tip and lubricate the outside of the **mixing chamber**.
2. Place the **mixing chamber** in the **nozzle body** with its groove aligned with the abrasive inlet hole:

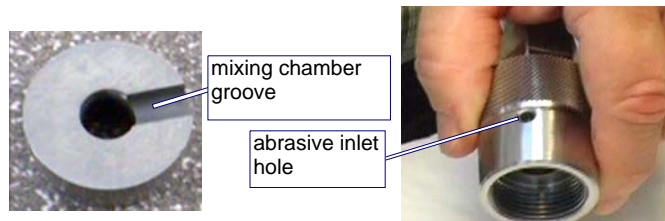

Figure 6-46: Locating the Mixing Chamber Groove and Abrasive Inlet Hole for Alignment

Note: An assembly trick is to mark the top edge of the nozzle body with a marker to identify where the abrasive inlet hole is located when lining up the mixing chamber.

3. Screw the **mixing tube retainer nut** onto the **nozzle body threads** to prevent thread damage, or place a **1-3/16" deep-well socket** over the 1" hex on the **nozzle body** for support (Figure 6-47).
4. Place the **nozzle body** in the **arbor press** and press the **mixing chamber** into the nozzle body bore using the **0.550" push tool** and a **1" deep-well socket**.

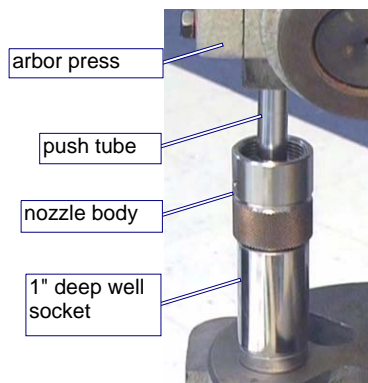

Figure 6-47: Using the Push Tool and Arbor Press to Insert the Mixing Chamber into the Nozzle Body

Note: If you have trouble inserting the mixing chamber, placing it in a freezer prior to insertion makes it easier to fit into a tight nozzle body.

5. Measure the internal depth of the remaining bore in the **nozzle body** from the top of the bore to the top of the **mixing chamber**. This gap must measure approximately 0.130" (3.3 mm) in order to accommodate the **mixing chamber disc** and **orifice assembly** when inserted.

Mixing Chamber Disc and Orifice Assembly

1. Install an **O-ring** onto the **nozzle body**.



Figure 6-48: Installing the O-ring on the Nozzle Body

Caution: *Ensure that the nozzle body, the mixing chamber disc, and the mixing chamber surfaces are clean and contamination free.*

2. Assemble the **mixing chamber disc** and **orifice assembly** inside the **nozzle body**:
 - a. Place the **mixing chamber disc** on the **mixing chamber** in the center bore of the **nozzle body**.

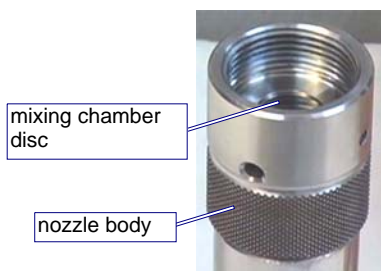

Figure 6-49: Placing the Mixing Chamber Disc in the Center Bore of the Nozzle Body

- b. Ensure that the **mixing chamber disc** sits flat on the **mixing chamber**, leaving a 0.030" (0.76 mm) deep bore to accommodate insertion of the **orifice assembly**.
 - c. Insert the **orifice assembly** with the jewel side facing up into the **nozzle body bore** and on top of the **mixing chamber disc**.

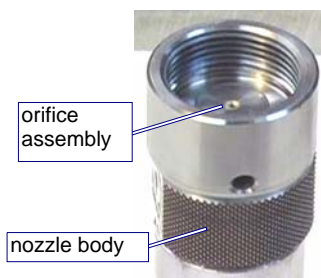

Figure 6-50: Inserting the Orifice Assembly in the Nozzle Body with the Jewel Side Facing Up

Note: *Ensure that the orifice assembly is well-seated in the 0.030" (0.76 mm) counter bore above the mixing chamber disc. Ensure that no contamination exists between the orifice assembly and the mixing chamber disc as this will impact jet stream alignment and increase mixing tube wear.*

Nozzle Body

1. Apply a light coating of **Blue Goop** to the female threads of the **nozzle body inlet**.

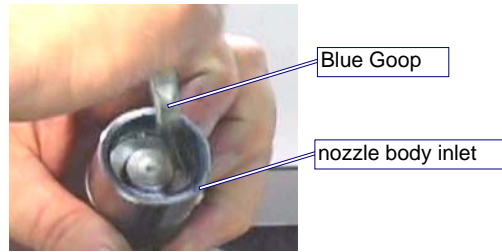

Figure 6-51: Applying Blue Goop to the Nozzle Body Inlet Threads

2. Carefully hold the **nozzle body** to keep the **mixing chamber disc** and **orifice assembly** leveled and centered in their positions in the bore.
3. Carefully begin to screw the **nozzle body** with the **orifice assembly** onto the machine's **nozzle inlet body**.

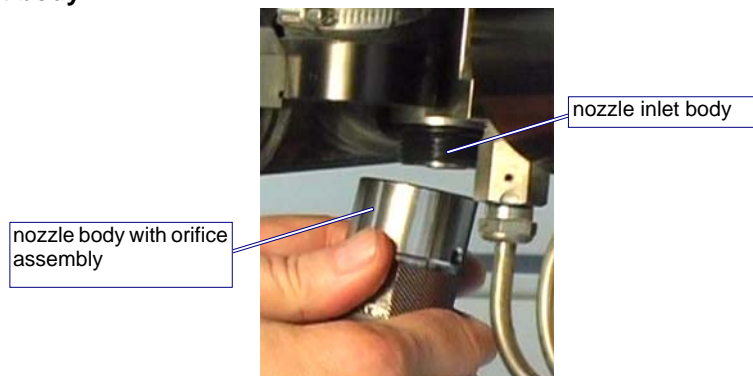

Figure 6-52: Installing the Nozzle Body onto the Nozzle Inlet Body

4. Twist the **nozzle body** slowly to keep the **mixing chamber disc** and **orifice assembly** seated flat and centered in their correct positions. Twist until you begin to feel resistance from the **nozzle body** and the **nozzle inlet body**.

Note: The threads on the nozzle assembly of the Tilt-A-Jet are clocked to ensure that the abrasive inlet hole ends up in the proper position for attaching the abrasive hose:

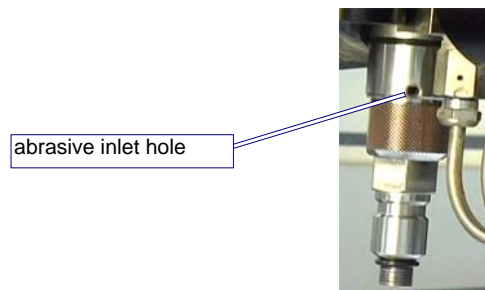

Figure 6-53: Aligning the Nozzle's Abrasive Inlet Hole

If the orifice assembly is not seated properly prior to tightening, the abrasive inlet hole will not end up in the correct position and will also cause damage to the inlet body. If this happens, check the seating of the components inside the nozzle assembly to ensure that they are centered and seated properly (specifically,

check to see if the orifice assembly is still seated in the bore). Refer to Figure 6-54 for an example of an orifice that had been tightened several times while off-center and not correctly seated in its bore.



Figure 6-54: Damage Caused by an Off-center Orifice

5. Place the **spanner wrench** onto the **brass retaining nut** at the top of the **nozzle body** and a **1/2" box end wrench** on the upper hex of the **inlet body** and tighten the **brass retainer nut**.

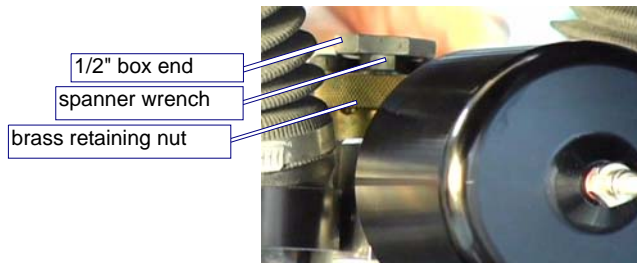

Figure 6-55: Tightening the Nozzle's Brass Retainer Nut

6. Remove the **spanner wrench** and use the **1/2" box end wrench** to hold the **inlet body** in place to counteract any torque when tightening the **nozzle body**. Using a **1" open-end wrench** placed on the **nozzle body**, turn slowly clockwise to tighten the **nozzle body** to the **inlet body**.

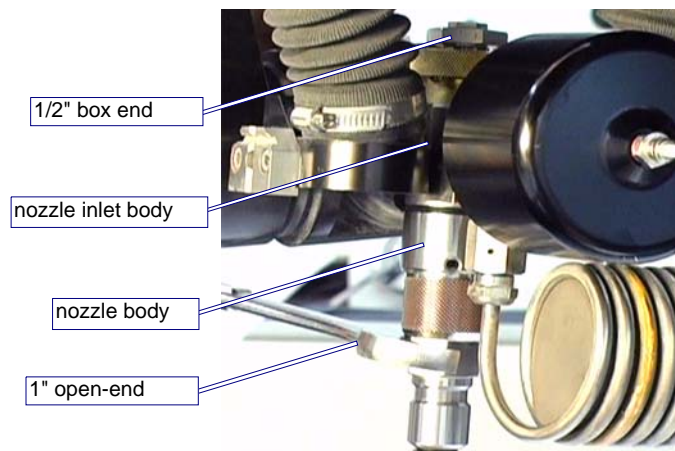

Figure 6-56: Tightening the Nozzle Body to the Inlet Body

7. Tighten the **nozzle body** to approximately 30 - 40 ft-lb (40.7 - 54.2 N·m).

Caution: The nozzle body uses a soft filter seal, not a high-pressure metal-to-metal seal. Do not overtighten! The ring seal and O-ring make the seal, not the torque of the body. Over-tightening will not fix a leak and most likely creates additional repair issues. If you have a leak, inspect the sealing surfaces and replace the seal and O-ring as necessary.

Mixing Tube

1. Insert the **mixing tube** into the **nozzle body**.

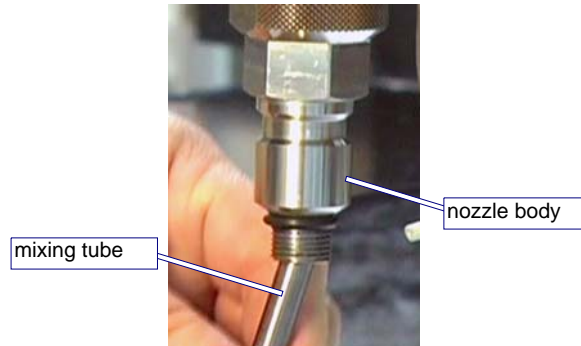

Figure 6-57: Inserting the Mixing Tube into the Nozzle Body

2. Slip the **mixing tube collet and nut** onto the **mixing tube** and insert the **mixing tube** all the way into the **nozzle body** until it bottoms out against the clean surface of the **mixing chamber**.

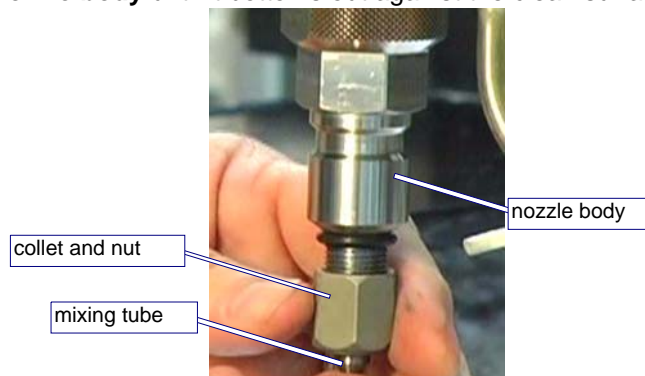

Figure 6-58: Placing the Mixing Tube Collet and Nut onto the Mixing Tube

3. While holding the **mixing tube** in place, tighten the **nut** to a snug fit with an **11/16" open-end wrench**. To counteract any torque, place a **1" open-end wrench** on the hex of the **nozzle body** while the **nut** is being tightened.

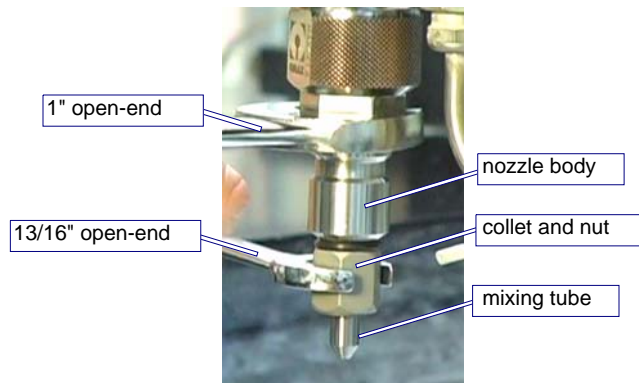

Figure 6-59: Tightening the Mixing Tube onto the Nozzle Body

Nozzle Tests

Once the nozzle has been installed, run the standard nozzle tests provided in OMAX's **Make** software to verify the water seal of the assembly fittings and the jet stream quality:

1. Set the tip of the **mixing tube** no higher than 1.5" above the water level to prevent the jet stream from piercing too far down into the tank.

WARNING! *Eye protection must be worn at all times when operating the OMAX JetMachining Center. Always wear ear protection when operating the abrasivejet nozzle out of water. An out-of-water abrasivejet can produce noise in excess of 120 decibels.*

2. First, test **nozzle** operation with **Water** only at **Low** pressure and then follow by testing with **Water and Abrasive** at **High** pressure. Refer to Figure 6-40 for an illustration of the pump and nozzle test screen.
3. When running these **pressure tests**, inspect for water leaking from the **high-pressure fittings** and inspect the jet stream to ensure it remains straight and focused. Refer to Figure 4-20, "Example of Both Good and Poor Quality Jet Streams" on page 4-15. The jet stream should be narrow and well-formed near the nozzle. A certain amount of spreading is to be expected at approximately 1.5 to 2.0" (3.8 to 5.1 cm) down the jet stream. A bad jet stream will be wide and poorly formed and flares almost immediately upon leaving the nozzle. Refer to Figure 4-22 on page 4-16.

Caution: *Always repair all problems noted during nozzle testing prior to operating the equipment.*

Maximizing Nozzle Life

There are a number of simple things you can do to maximize the life of your nozzle components:

- Don't change the Mixing Tube simply because the jet stream looks wide.
- Cut test parts and do kerf checks on a regular basis to see when cutting performance begins to degrade.
- If the surface quality and accuracy are as expected, continue using the Nozzle Assembly.
- If the quality of the cut part is not as expected, prompt correction of the problem minimizes complications.
- Take advantage of features in the OMAX **Make** software that allow the using of different offset values and mixing tube diameters to adjust for Mixing Tube wear.
- Maintain part tolerances and extend Mixing Tube use by entering the correct offset value in **Make**.

All nozzle components are negatively affected by contamination, dirt, or other materials present in high-pressure systems. In general, cleanliness is a key controllable factor in extending the life of nozzle components. Some simple but effective ways to maintain cleanliness include:

- Keep your work area clean.
- Store spare nozzle components and other parts in sealed, clean containers or bags until ready for use.
- Thoroughly clean all parts and high-pressure fittings prior to assembly or reassembly.
- Use an ultrasonic cleaner with white vinegar to remove mineral build-up in the orifice assembly.
- Prevent garnet contamination:
 - Don't store garnet in open bags or buckets – store in closed containers.
 - Use a sharp blade to open abrasive bags.
 - Always keep the top of the abrasive hopper covered to prevent water from entering.

Some best practices pertaining to parts and components will also lead to extended nozzle life:

- Do not use damaged parts. Visually inspect parts and all orifices prior to use.
- Always use pump manifold and last chance nozzle filters. Inspect and replace them on a regular basis.

- Consider using a diamond orifice assembly if orifice chipping is a chronic problem not overcome by using filters or by following proper procedures.
- Depending on your application, and if speed and longer life are the primary concern, use a 0.042" mixing tube instead of the standard 0.030" mixing tube. Be aware that parts will have slightly more taper and a wider kerf.
- If unusual cutting conditions are permitting dirty water to enter the nozzle vent hole, route a piece of tubing from the vent hole to the top of the Z-axis.
- Use only high-quality abrasive as it contains less dust and a more uniform particle size.
- Use a nozzle guard assembly to help protect the mixing tube from damage during cutting.

To reduce nozzle maintenance downtime:

- Have a spare nozzle body built and ready to replace on the machine when needed.
- Have new consumable parts on hand and replace them when rebuilding the nozzle. Once the nozzle is installed and running, determine which parts can be reused as spares in the future.

Some machine practices that will also extend the life of the nozzle and its components are as follows:

- Use a nozzle muff and, whenever possible, cut underwater to reduce splash-back. The splash-back contains water, garnet, and eroded material from the tank. Figure 6-60 provides an example of the damage caused to a Tilt-A-Jet assembly when the machine cut without a muff. This is preventable damage that will affect your warranty.



Figure 6-60: Abrasive Damage from Not Using a Nozzle Muff

- After servicing the pump, nozzle, or replacing a piece of hard-plumbing, always flush the system by performing a "water only" test for several minutes with both the orifice and last chance filter removed. To correctly flush your plumbing system, refer to the OMAX document, "Pulse/Surge Flushing of the UHP System", P/N 400571B. This document can be downloaded from the OMAX web site in the Customer Service/Field Technician section at www.omax.com.
- Rotate the Mixing Tube 90° following every eight hours of cutting. This distributes wear more evenly around the internal diameter of the Mixing Tube if the orifice is chipped or misaligned.

Removing and Reinstalling the Inlet Body on a Tilt-A-Jet

The inlet body is an infrequent consumable item; however, because it cycles between 0 Psi and 55 Ksi with every ON/OFF cycle, it eventually can wear or crack.

1. Disconnect the **air hose** that goes into the **ON/OFF valve** by pushing back on the **air canister actuator fitting ring** on top of this valve and pulling on the air hose.

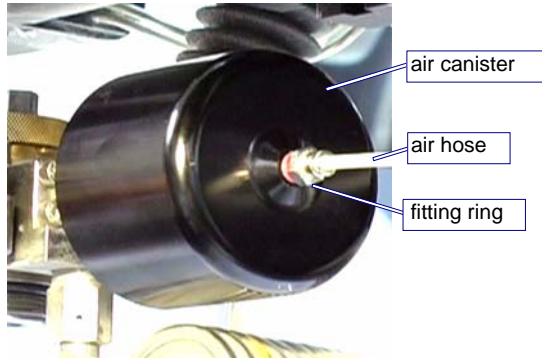

Figure 6-61: Removing the Air Hose from the Air Canister Fitting Ring

2. Use a **1-1/8" open-end wrench** to unscrew the **ON/OFF valve air canister** from the **ON/OFF valve body**.

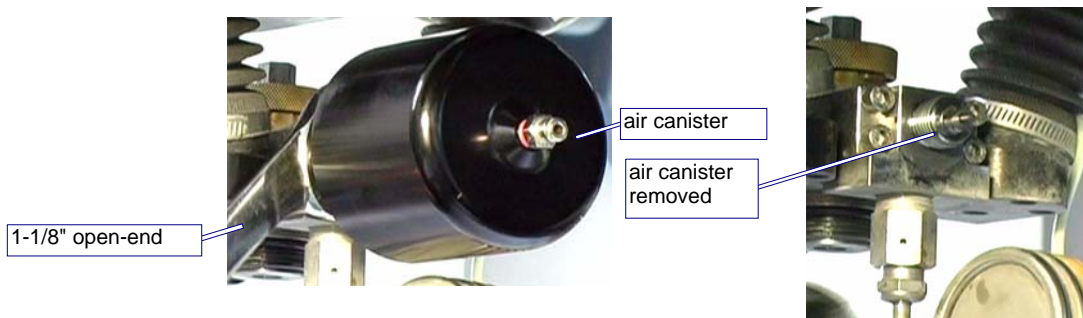

Figure 6-62: Using a 1-1/8" open-end Wrench to Remove the Air Canister

3. Use a **5/8" and a 3/4" open-end wrench** to carefully remove the **coil nipple** from the **ON/OFF valve body adapter fitting**. Set this coil aside.

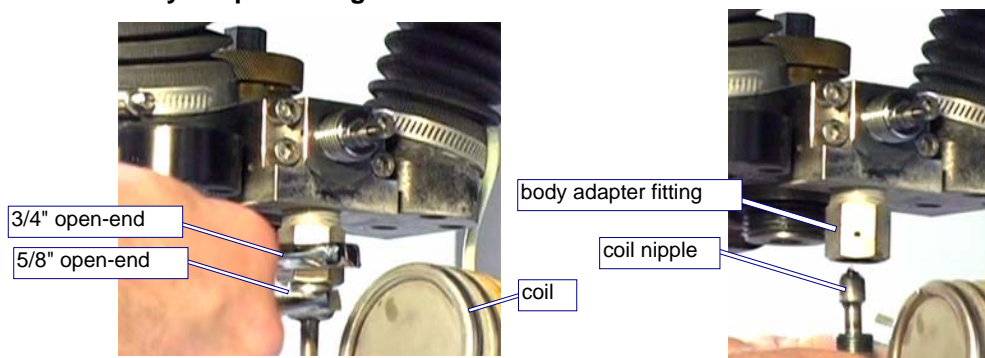

Figure 6-63: Removing the Coil Nipple From the ON/OFF Valve Body Adapter Fitting

- Using a **5 mm Allen wrench** and following a continual pattern, loosen the four **screws** that secure the **ON/OFF valve body** to the **tilting plate** (loosen each screw using a ¼ to ½ turn at a time until all screws are loose). Remove the four **screws** from the **tilting plate**.

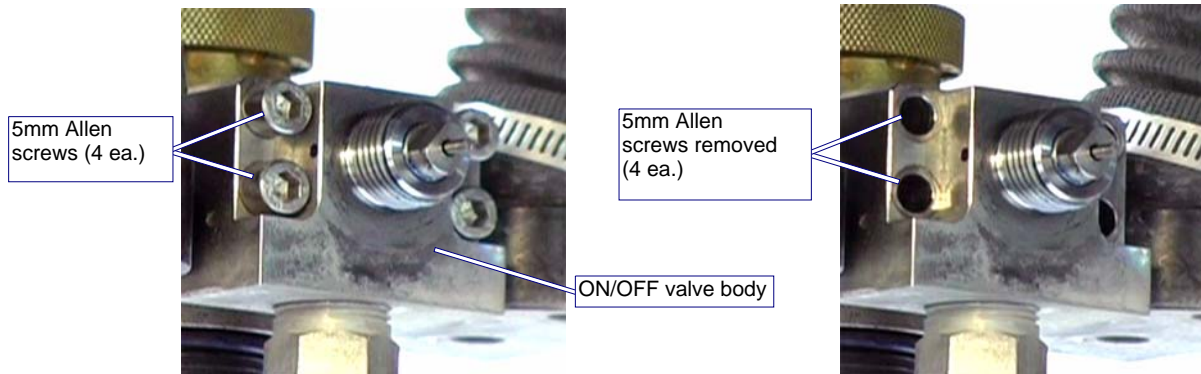

Figure 6-64: Removing the 5mm Allen Screws that Secure the ON/OFF Valve Body

- Pull the **ON/OFF valve body** with the **valve body seat** out of the **tilting plate**.

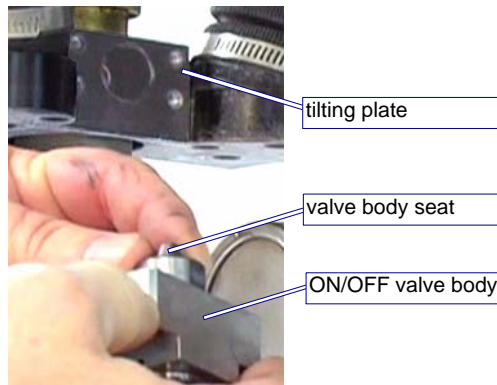

Figure 6-65: Removing the ON/OFF Valve Body with Seat from the Tilting Plate

- Place a **spanner wrench** on the **brass retainer nut** that holds the **inlet body** and place a **1/2" wrench** on the upper hex of the **inlet body**, holding it in place to counteract any torque while removing the **inlet body** from the **tilting plate**.

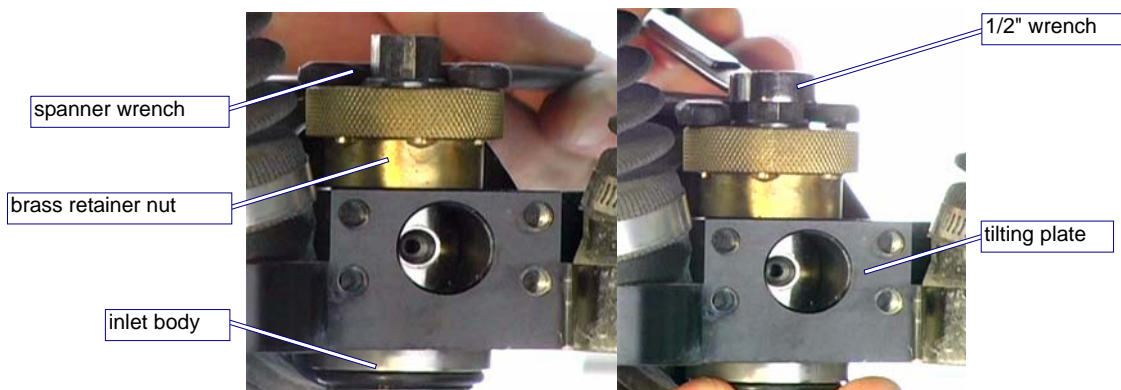

Figure 6-66: Removing the Inlet Body from the Tilting Plate

- Use the **spanner wrench** to loosen the **brass retainer nut** while holding the **inlet body**. The **inlet body** should detach from the machine at this time.

Caution: *If the inlet body is stuck, you may need to use the tools provided in kit, Part Number 304096, to remove it. Under no circumstances should a hammer or similar object be used to strike this assembly!*

Cleaning the Inlet Body

1. After removing the **inlet body**, clean the hole where the **inlet body** sits, using a brush with soapy water to remove any grit buildup.



Figure 6-67: Cleaning the Inlet Body Hole with Brush and Soapy Water

2. Rinse the hole with clean water and blow it completely dry using compressed air.
3. Also clean the removed **inlet body** with mild, non-abrasive soap and water, rinsing it with clean water and blowing it dry.

Reinstalling the Inlet Body

1. Apply a light coating of **Blue Goop** to the male threads of the **inlet body** and to the bore diameter around the **inlet cone** to minimize water deposit buildup around the **inlet body**.

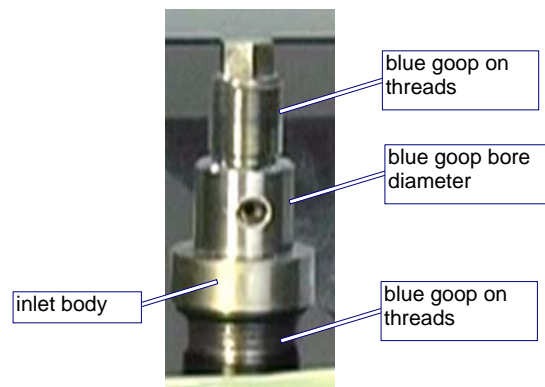

Figure 6-68: Applying Blue Goop to the Inlet Body Male Threads and Bore Diameter

2. Insert the **inlet body** through the **tilting plate**. Screw the **brass retaining nut** onto the **inlet body** and hand-tighten it to the **tilting plate**. Rotate the **inlet body** until the hole in the **inlet body** appears in the center of the hole in the **tilting plate**.

Note: Only hand-tighten at this time to allow the ON/OFF Valve and high-pressure plumbing to be properly aligned in the steps that follow.

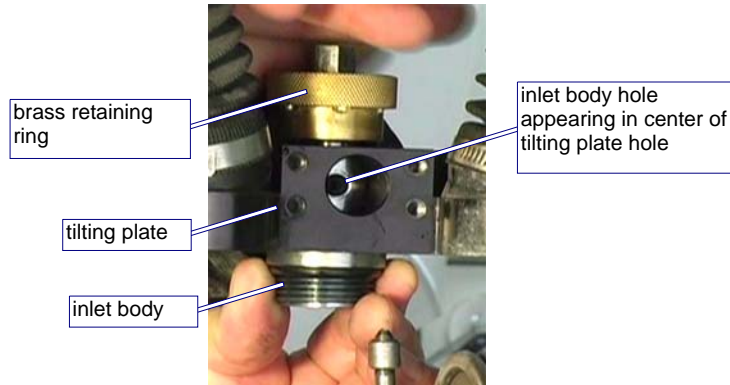

Figure 6-69: Hand Tightening the Inlet Body and Aligning to Tilting Plate Hole

3. Apply a small amount of **anti-seize** to the threads on each of the 4 **Allen-head screws**.
4. Apply **Blue Goop** to the fitting threads and the **ON/OFF valve body seat**.

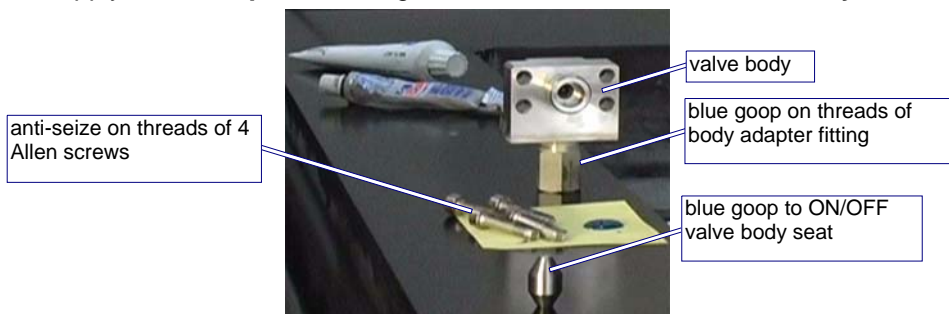

Figure 6-70: Applying Blue Goop and Anti-seize Compounds to Valve Body Components

5. Insert the **valve body seat** into the **ON/OFF valve body** with the small hole end inward and the large hole end pointing outward (see Figure 6-71).

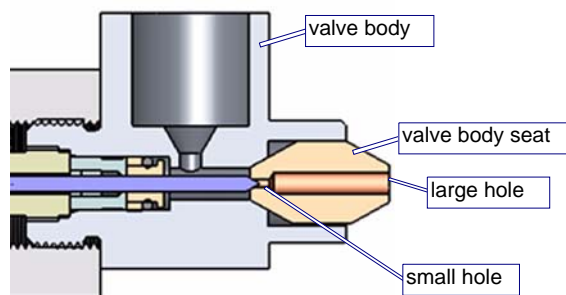

Figure 6-71: Correct Placement of the Valve Body Seat into the Valve Body

- Place the **ON/OFF valve body** against the **nozzle inlet body** and line up the **valve body seat**.

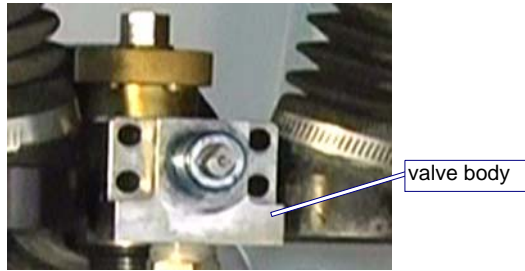

Figure 6-72: Placing the ON/OFF Valve Body Against the Cutting Head Inlet Body

- Using a **5 mm Allen wrench** and following a tightening pattern, reinstall and tighten the four screws that secure the **ON/OFF valve body** to the **tilting plate**. Tighten $\frac{1}{4}$ to $\frac{1}{2}$ turn at a time until all screws are tightened evenly. Apply a coating of **Blue Goop** to the **gland nut** of coil nipple fitting.

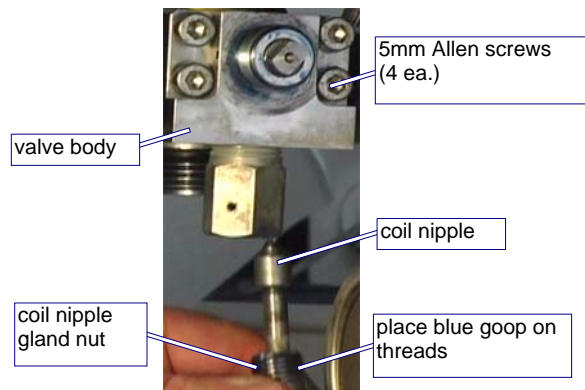

Figure 6-73: Tightening the Four Valve Body Screws and Applying Blue Goop to the Gland Nut Threads

- Using a **5/8"** and a **3/4"** **open-end wrench**, carefully reinstall the **coil nipple** to the **ON/OFF valve body adapter fitting**.

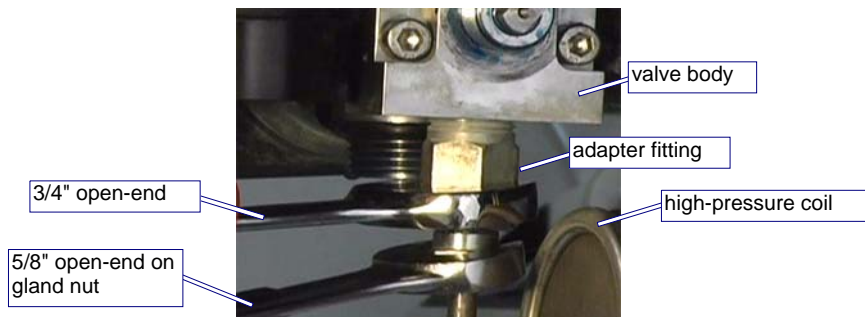

Figure 6-74: Tightening the Coil Nipple to the ON/OFF Valve Body Adapter Fitting

Caution: Be careful not to allow torque to twist the high-pressure coil as you tighten.

9. Screw the **ON/OFF valve air canister** back onto the **ON/OFF valve body**, tightening it with a **1-1/8" open-end wrench** (torque at 250 in-lb).

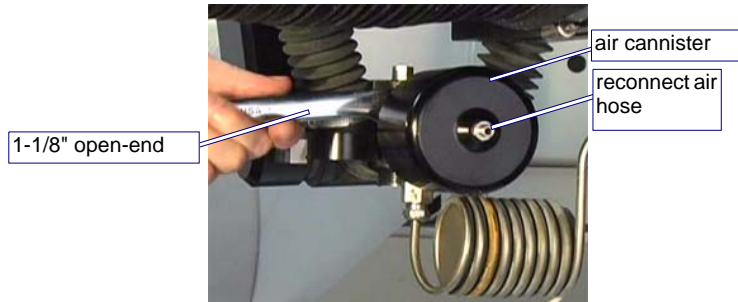

Figure 6-75: Installing the ON/OFF Valve Air Canister

10. Reconnect the **air hose** going to the **ON/OFF valve** by pushing the hose into the **air canister actuator** on top of the valve.

Removing and Reinstalling a Mini-MaxJet 5 Nozzle Assembly

This section provides additional steps that are required when removing and repairing an OMAX MaxJet 5 MiniJet Nozzle Assembly from a Tilt-A-Jet.

Disassembling a MiniJet Nozzle

The procedure for removing the MiniJet nozzle assembly from a Tilt-A-Jet are the same as removing a MaxJet 5 Nozzle Assembly with the exception of the additional steps required to remove the Inlet Body Extension, the Dummy Orifice, and the additional o-rings and Ring Seals specific to the MiniJet nozzle.

Note: Only the additional steps required to remove the MiniJet nozzle from the Tilt-A-Jet are presented here. Refer to the steps presented in *Removing a MaxJet® 5 Nozzle Assembly from a Tilt-A-Jet* on page 6-25 for common procedures.

Removal Procedures

Step 1: Remove the Nozzle Mixing Tube

Step 2: Remove the MiniJet Nozzle Body from the Inlet Body Extension (page 6-46)

Step 3: Remove the Inlet Body Extension from the Inlet Body (page 6-47)

Step 4: Remove the MiniJet Dummy Orifice from the Inlet Body Extension (page 6-48)

Step 5: Remove the Nozzle Filter from the Inlet Body

Step 6: Remove the Orifice Assembly

Step 7: Remove the Mixing Chamber Disc

Step 8: Remove the Mixing Chamber

Step 9: Remove the O-Rings and Ring Seals (page 6-48)

Step 10: Clean the Nozzle Components

Step 11: Inspect the Nozzle Components

Step 2: Remove the MiniJet Nozzle Body from the Inlet Body Extension

The MiniJet nozzle assembly has an inlet body extension component that is attached between the nozzle body and the inlet body and requires removal.

1. To remove the **MiniJet nozzle body** from the **Inlet body extension**, place a **1-1/8" open-end wrench** on the **Inlet body extension**.

Caution: *Hold the inlet body in place to counteract any induced torque when removing the inlet body extension. This prevents induced torque from affecting the Tilt-A-Jet's alignment and accuracy.*

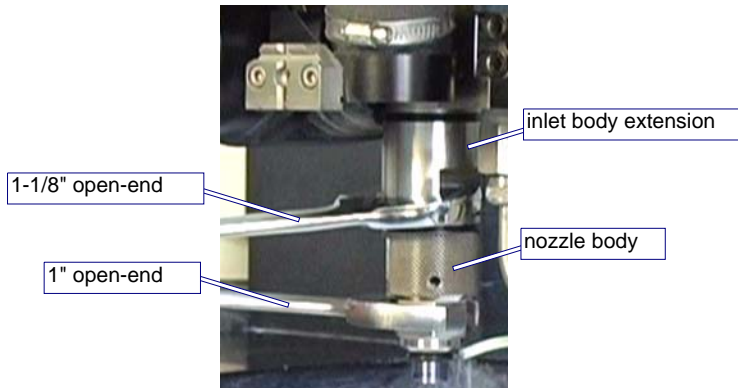

Figure 6-76: Removing the MiniJet Nozzle Body from the Inlet Body Extension

2. With a **1" open-end wrench** placed on the **nozzle body**, loosen the right-hand threaded **nozzle body** from the **inlet body extension** using both wrenches (Figure 6-76) and unscrew the **nozzle body** the rest of the way by hand.

Step 3: Remove the Inlet Body Extension from the Inlet Body

1. Place a **1/2" wrench** on the **inlet body** located at the top of the **nozzle assembly**.

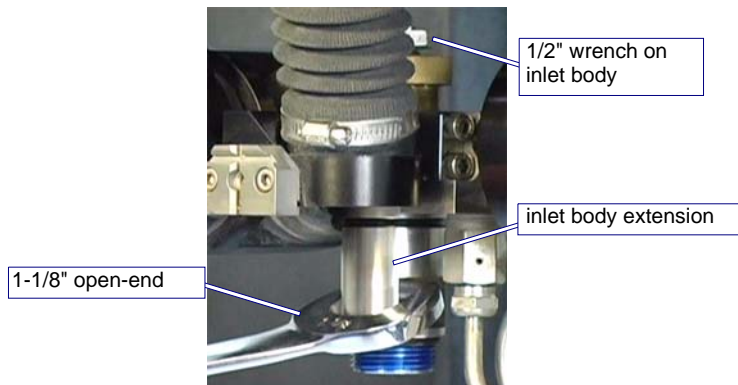

Figure 6-77: Removing the Inlet Body Extension from the Inlet Body

Caution: *Hold the inlet body in place to counteract any induced torque when removing the inlet body extension. This prevents induced torque from affecting the Tilt-A-Jet's alignment and accuracy.*

2. Using a **1-1/8" open-end wrench** placed on the **inlet body extension** (Figure 6-77), unscrew the right-hand threaded **inlet body extension** from the **inlet body**.

Note: *The Inlet body extension is a consumable item; however, it is expected to last through multiple nozzle rebuilds.*

3. Inspect the surface on each end of the bore on the **inlet body extension** for erosion marks. If there are erosion signs, the ring seal(s) may leak, requiring that the **inlet body extension** be replaced.

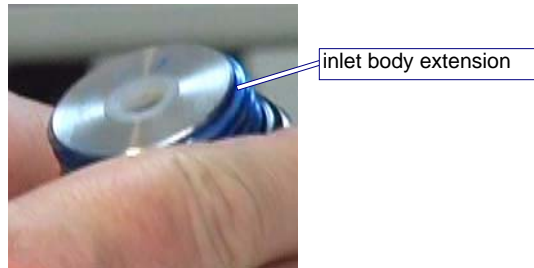

Figure 6-78: Inspecting the Body Extension for Erosion Marks

Step 4: Remove the MiniJet Dummy Orifice from the Inlet Body

The MiniJet also has a dummy orifice that sits at the top of the inlet body extension and needs to be removed. This dummy orifice provides a flat surface for the inlet body seals.

1. Remove the **dummy orifice** by tipping the Inlet **body extension** upside down and letting it fall out.

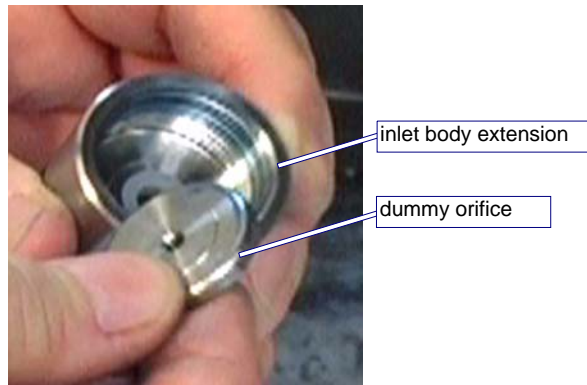

Figure 6-79: Inspecting the Dummy Orifice for Erosion Marks

2. Inspect the **dummy orifice** for erosion marks on both the upper and lower surfaces where the **ring seal** must seat. If there is evidence of erosion, the **ring seal(s)** will leak and the **dummy orifice** must be replaced.

Step 9: Remove Ring Seals and O-Rings

All ring seals and o-rings should be removed and replaced as needed during a nozzle rebuild.

1. Remove the **o-ring** from the **MiniJet nozzle body**.
2. Remove the **o-rings** and **ring seals** from the Inlet **body extension**.



Figure 6-80: Removing O-ring and Ring Seals from the Inlet Body Extension

Reassembling the MiniJet Nozzle Assembly

After the inlet body and filter seal assembly are installed on the machine, install the inlet body extension on the inlet body:

1. Lubricate the two **ring seal's** o-rings with Lubriplate and install them on the **ring seals**. See Figure 6-80 for an example of these ring seals.
2. Insert the **ring seal** assemblies into each end of the **inlet body extension**.

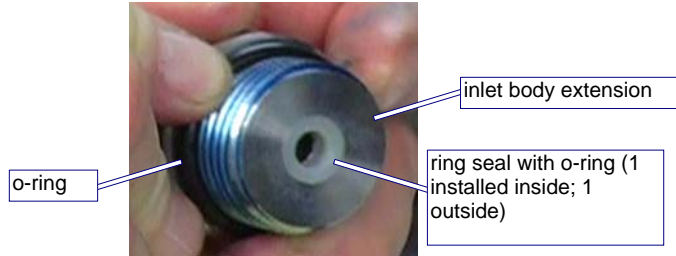

Figure 6-81: Installing Ring Seals and O-rings in the Inlet Body Extension

3. Place the large **o-ring** on the bottom of the **inlet body extension** (Figure 6-81).
4. Insert the **dummy orifice** inside the top of the **Inlet body extension**, ensuring that it sits flat against the **ring seal**.

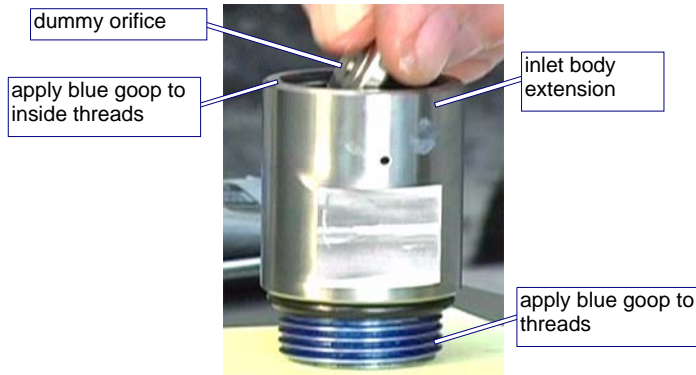

Figure 6-82: Inserting the Dummy Orifice into Inlet Body Extension

5. Apply **Blue Goop** to both the inside and outer threads of the **inlet body** prior to installing the **Inlet body extension**.
6. Slowly screw the **Inlet body extension** onto the **inlet body** and hand-tighten (Figure 6-83).
7. Place a **1/2" wrench** on the **inlet body** at the top of the nozzle assembly to hold the **inlet body** in place and counteract any induced torque when installing the **inlet body extension**. This prevents any induced torque from affecting the Tilt-A-Jet's alignment and accuracy.

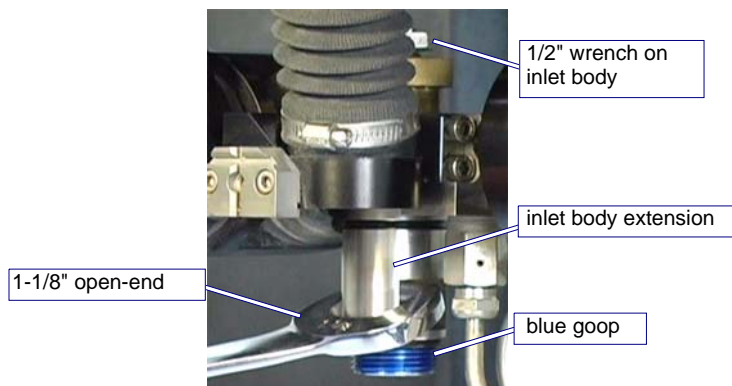

Figure 6-83: Tightening the Inlet Body Extension to the Inlet Body

8. Using a **1-1/8" open-end wrench** placed on the **inlet body extension**, tighten the right-hand threaded **Inlet body extension** to the **inlet body** using both wrenches (Figure 6-83).
9. Tighten the **inlet body extension** to approximately 30 - 40 ft-lb (40.7 - 54.2 N-m).
10. In the **MiniJet nozzle body**, ensure that the **orifice assembly** and **mixing chamber disc** are properly installed and can seat as required with the **inlet body extension**.

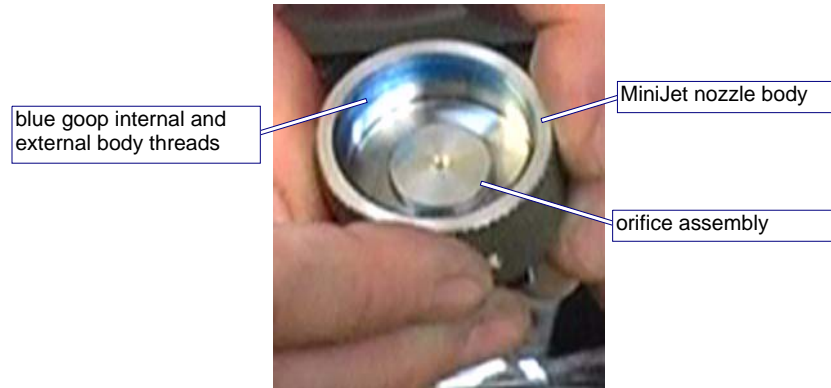

Figure 6-84: Inspecting for Properly Seated Orifice Assembly and Mixing Chamber Disc

Note: Any debris or misalignment of the orifice assembly will directly impact mixing tube life.

11. Apply **Blue Goop** to the internal and external threads of the **MiniJet nozzle body**.
12. Hand tighten the **MiniJet nozzle body** onto the **inlet body extension**.

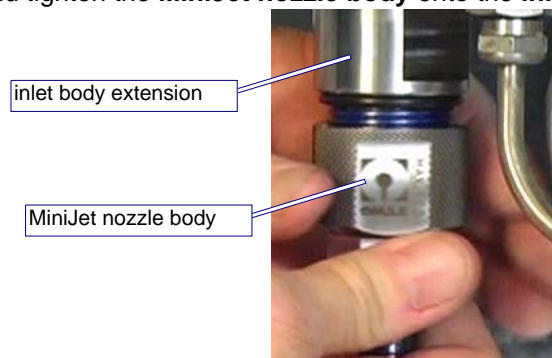

Figure 6-85: Hand Tightening MiniJet Nozzle Body to the Inlet Body Extension

13. Place a **1-1/8" open-end wrench** on the **inlet body extension** to hold the **inlet body extension** in place and counteract any induced torque when installing the **MiniJet nozzle body**.
14. Using a **1" open-end wrench** placed on the **MiniJet nozzle body**, carefully screw the right-hand threaded **nozzle body** to the **Inlet body extension** using both wrenches. Ensure that the **orifice assembly** always remains centered in the **nozzle body** bore.

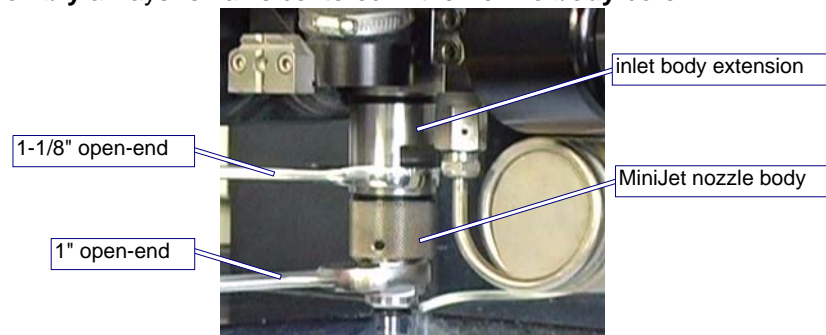

Figure 6-86: Tightening the MiniJet Body to the Inlet Body Extension

15. Tighten the **MiniJet nozzle body** to approximately 30 - 40 ft-lb (40.7 - 54.2 N-m).

Caution: *Do not overtighten! The ring seal and O-ring make the seal, not the torque of the body. Overtightening will not fix a leak and most likely creates additional repair issues. If you have a leak, inspect the sealing surfaces and replace the seal and O-ring as necessary.*

Mini-Maxjet 5 Installation and Operation

Installing the Mini-Maxjet 5

1. Remove the existing **Maxjet 5 nozzle body, orifice, and mixing tube**. Leave the **inlet body** in place.
2. Install the **Mini-Maxjet 5 assembly** onto the **inlet body**.
3. Pull the **abrasive valve** (refer to Figure 4-24) from the bottom of the cylindrical abrasive hopper.
4. Replace the existing **abrasive orifice** with the one provided with the **Mini-Maxjet 5 (P/N 301730-01)**.
5. Reinstall the **abrasive valve**.
6. Readjust the Adjustable Dump Orifice to match operating characteristics of the Mini-Maxjet 5 assembly. Refer to *Set the Adjustable Dump Orifice (ADO)*, page 4-4.

Operating the Mini-MAXJET 5

Caution: *To avoid deadheading the pump, lower its RPM to minimum before turning ON the nozzle jet. When operating the pump at lower RPMs, see *Changing Crankcase Oil* on page 5-36 for additional oil requirements. If you're not using a variable RPM pump, contact OMAX Technical Support.*

Note: *OMAX recommends using a 120–150 mesh garnet with the Mini-MAXJET 5 nozzle. To avoid plugging the nozzle, never use 80 mesh or coarser garnet.*

1. Calibrate the actual abrasive flow rate (refer to *Measure the abrasive flow rate*; page 4-17).
2. Click **Setup** in **Make** and select **Pump and Nozzle Settings**:

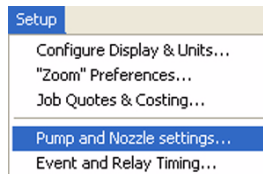

Figure 6-87: Setup Menu for Pump and Nozzle Settings

3. Correct any values being displayed that differ from those recorded when testing your OMAX machine. Change the “Abrasive Flow Rate” to the value you determined above (if calibration is not done, enter 0.3). Set the “Jewel (orifice) Diameter” to 0.010”, the “Mixing Tube Diameter” to 0.021”, and the “High Pressure” to the value set for your pump:

Pressure at Nozzle in High Pressure Mode:	50000	PSI
Pressure at Nozzle in Low Pressure Mode:	20000	PSI
Jewel (orifice) Diameter:	0.010	inches
Mixing Tube Diameter:	0.021	inches
Abrasive Flow Rate:	0.3	Lb/min
Abrasive Size:	120	Mesh (US Standard)
Abrasive Index:	1	(Use 1.0 for garnet)

Figure 6-88: Settings for Pump and Nozzle

4. Click **OK** to save your changes.

Note: The Low-pressure mode is not available when using the Mini-Maxjet4 nozzle - contact OMAX Technical Support for additional information.

- The tool offset for the Mini-MAXJET 5 nozzle should be determined after some test cuts are completed. The value of 0.012" may be used for the initial setup.

Rebuilding the Dual ON/OFF Valve

Maintenance of the Dual ON/OFF Valve is required when any of the following symptoms appear:

- Water enters the abrasive feed tube when the nozzle first fires (leaky seal).
- Water drips from the mixing tube (leaky valve stem).
- Water leaks 180° from where the UHP plumbing enters the dual ON/OFF valve (bad valve seal).
- Water drips from the UHP nipple on the dual ON/OFF valve (loose fitting, cracked body or fitting).

Use the following procedure to repair a faulty Dual ON/OFF Valve.

Removing the Dual ON/OFF Valve

Figure 6-89 below illustrates an OMAX Dual ON/OFF Valve connected to a MAXJET 5 Nozzle:

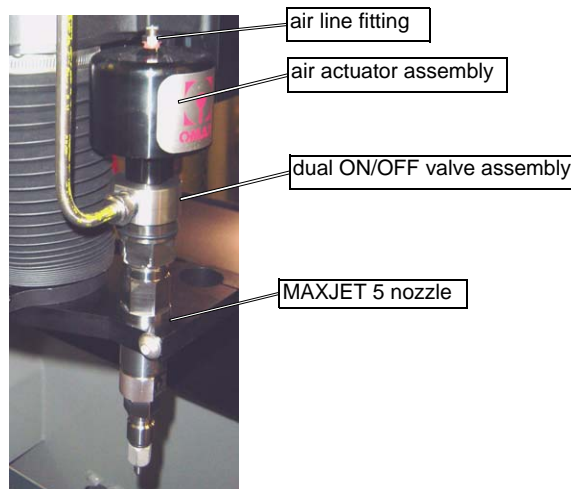

Figure 6-89: Dual ON/OFF Valve with the MAXJET 5 Nozzle

To remove the Dual ON/OFF Valve assembly:

1. Switch OFF the AC power for both the pump and table. Disconnect their main AC power breaker. Attach an "Out of Service" tag on this breaker and observe all applicable electrical safety procedures.
2. Remove the air line from the **air line fitting** on top of the **air actuator assembly** (Figure 6-90) and move it out of the way.

WARNING! *Before removing the air line, you must first power OFF the pump! Once the air line controlling the ON/OFF valve is removed, the nozzle becomes active.*

3. Remove the **air actuator assembly** from the **valve body** using a 1-3/8" open end wrench.

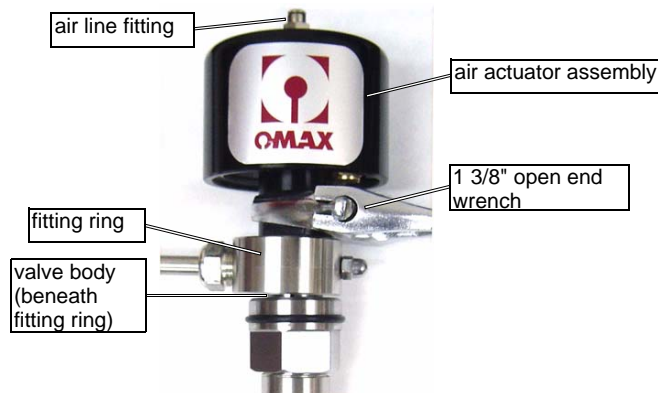

Figure 6-90: Removing the Air Actuator Assembly

4. Remove the **retaining screw** from the **valve body** using the 1/4" open end wrench.



Figure 6-91: Removing the Retaining Screw from the Valve Body

5. If possible, leave the UHP tube tightened in the **fitting ring** until the valve **gland nut** is loosened. After that, remove the UHP tubing from the fitting ring.

Caution: Always use two wrenches when removing a gland nut!

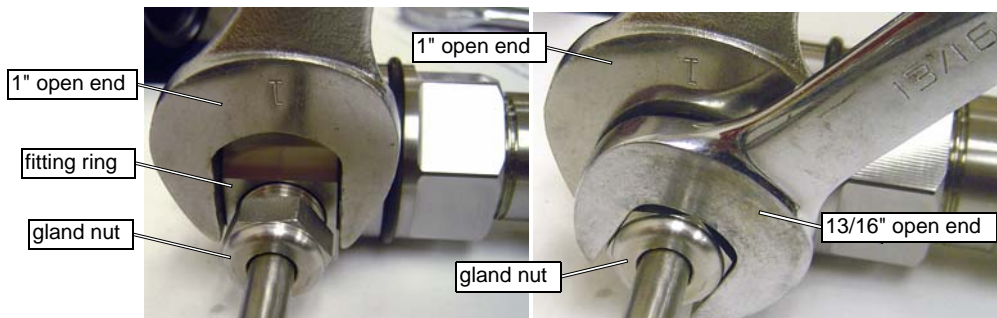

Figure 6-92: Loosening the Valve Gland Nut using Two Open End Wrenches

6. Loosen the **valve gland nut** from the **inlet body** by placing a 13/16" open end wrench on the **valve gland nut**.

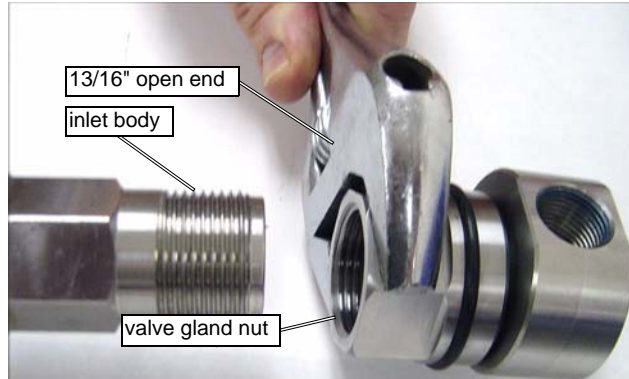

Figure 6-93: Removing the Valve Gland Nut from the Nozzle Assembly

7. Rotate the **ON/OFF valve assembly** away from the high pressure nipple and remove the **valve gland nut**.
8. Remove the **gland nut** from the fitting ring (Figure 6-92) and carry the **Dual ON/OFF Valve Assembly** to a clean work area for rebuilding.

Caution: *The ON/OFF seat is not secured in the valve body at this point and may fall out when carried.*

Disassembling the Dual ON/OFF Valve

Caution: The ON/OFF valve and its rebuild location must be thoroughly cleaned prior to rebuilding.

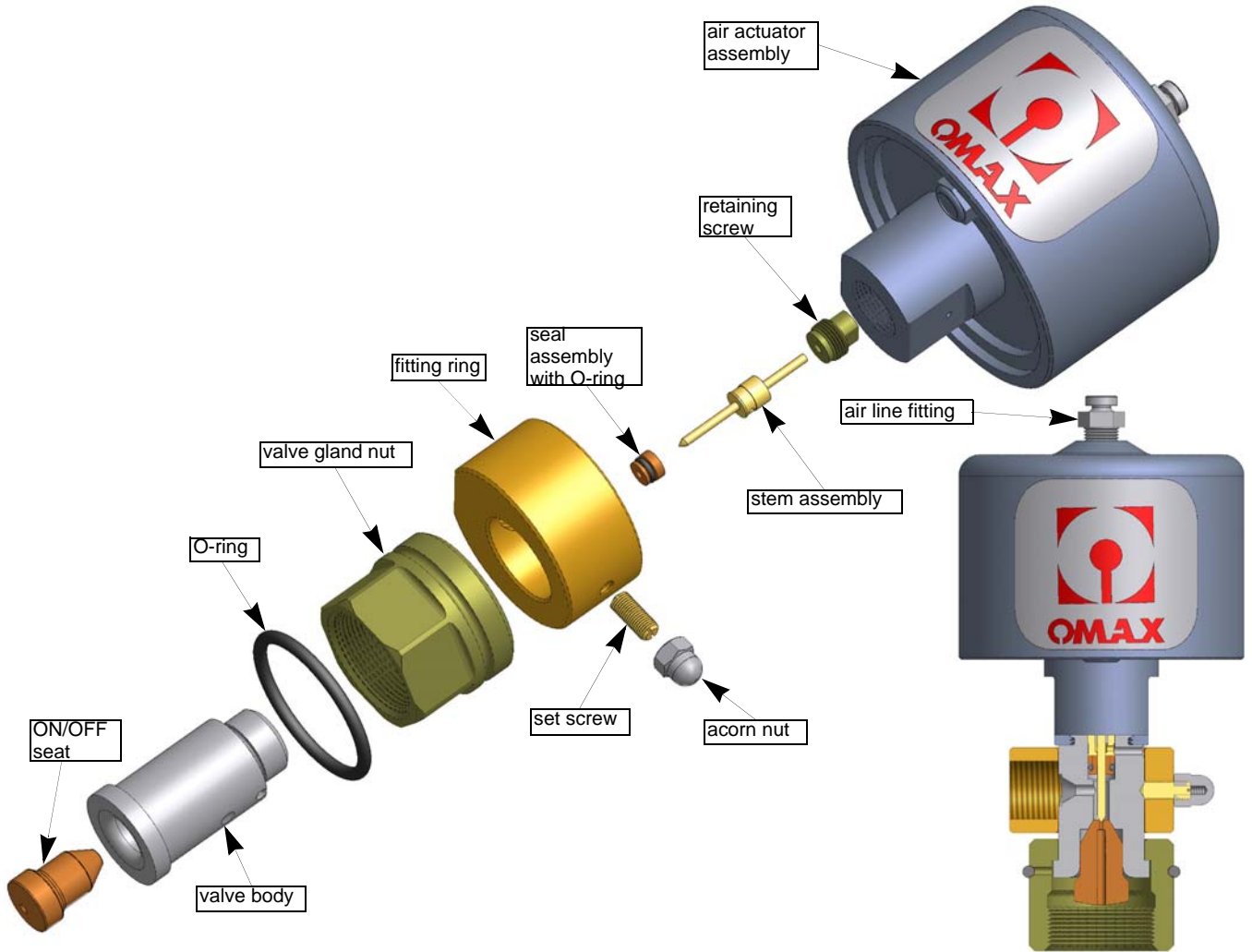

Figure 6-94: Components of the OMAX Dual ON/OFF Valve

1. Ensure that your working area for rebuilding this assembly is clean with all required **tools** and **materials** available (see page D-1 for list).
2. Pull the **fitting ring** and **valve gland nut** from the **valve body**.

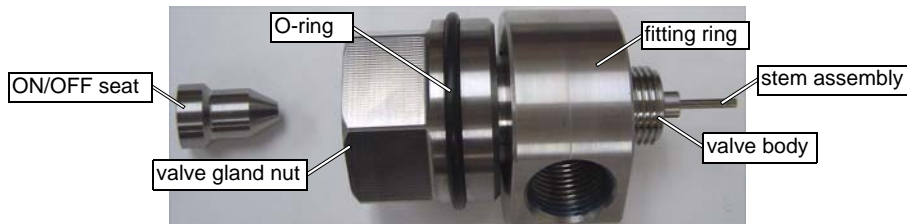

Figure 6-95: Components of the Dual ON/OFF Assembly

3. Use the needle nose pliers to remove the **stem assembly** from the **valve body**.

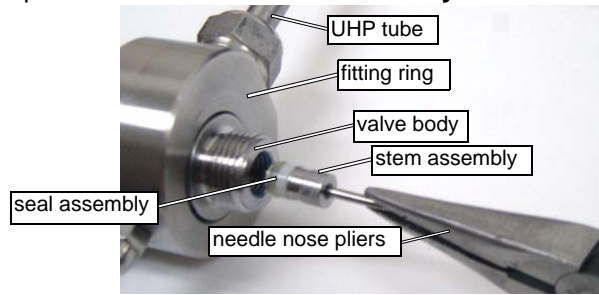

Figure 6-96: Removing the Stem Assembly from the Valve Body

4. If the seal assembly remains in the valve body, use the end of an Allen wrench (or other long tool approximately 3mm in diameter) to push the **seal assembly** out of the **valve body**.

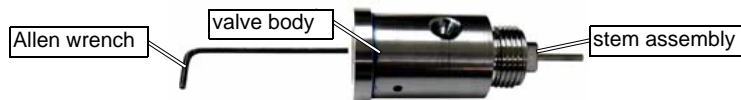

Figure 6-97: Pushing the Seal Assembly from the Valve Body

5. Clean all parts not being replaced in the repair kit. Discard the used **ON/OFF seat**, **seal assembly with O-ring** and **stem assembly**.



Figure 6-98: Discard the ON/OFF Seat, Seal Assembly, and Stem Assembly

Note: All items included in the Dual ON/OFF Valve Repair Kit (P/N 301927) must be used. Do not reuse any parts that are provided in the repair kit. Reusing these parts will decrease the life of your rebuilt ON/OFF valve assembly.

6. Carefully inspect the **valve body** for cracks and other defects. Cracked and damaged parts must always be replaced.

Reassembling the Dual ON/OFF Valve

1. From the ON/OFF valve repair kit, locate the **ON/OFF seat**, the **seal assembly with O-ring**, and the **stem assembly**.

2. Slide the **seal assembly** onto the **stem assembly** shaft with the **O-ring** facing towards the **valve body** (Figure 6-100). Ensure that the seal assembly slips over the **pointed end** of the stem assembly.

3. Lubricate both the **seal assembly O-Ring** and the **stem assembly** with Lubriplate grease:

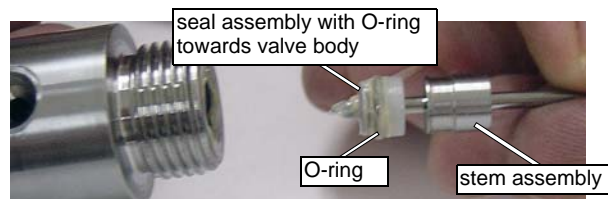

Figure 6-99: Apply Lubriplate to Seal and Stem Assemblies

4. Lightly coat the **valve body** bore down past the threads to the internal lip with Lubriplate grease:

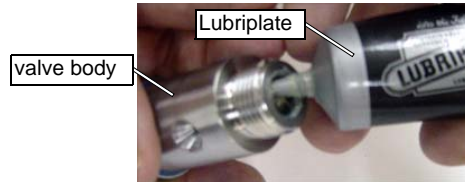

Figure 6-100: Apply Lubriplate to Valve Body Bore

5. Tightly grasp the **stem** assembly with the **seal assembly** installed and gently push them down into the lubricated **valve body** bore:



Figure 6-101: Insert the Stem and Seal Assemblies into the Valve Body

Note: If the stem assembly body resists insertion into the valve body because of the seal assembly O-ring, push the stem assembly body in using the end of an Allen wrench (or equivalent long tool) until the internal threads of the valve body are exposed.

6. Apply some **Blue Goop** onto the threads of the **retaining screw** and install it in the **valve body** using the 1/4" open end wrench.

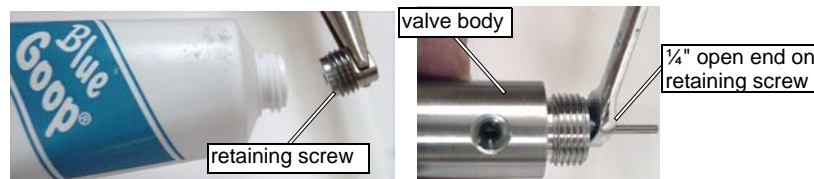

Figure 6-102: Applying Blue Goop and Installing the Retaining Screw

7. Apply **Blue Goop** to each end of the **ON/OFF seat** where it will contact the **valve body** and also where it will contact the bulkhead adapter. Insert it into the **valve body** (or place it in the inlet body).

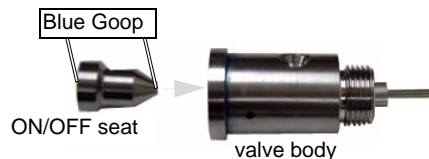

Figure 6-103: Insert the Stem Assembly into the Valve Body

8. Slide the **valve gland nut** and **fitting ring** onto the **valve body** (refer to step #2 in the disassembly instructions).



Figure 6-104: Sliding the Valve Gland Nut and Fitting Ring onto the Valve Body

9. The repair of the Dual ON/OFF Valve is complete.

Installing the Dual ON/OFF Valve

1. Verify that the ON/OFF seat remains in the valve body. Hand tighten the **valve gland nut** onto the nozzle inlet after rotating the **valve body** so that the UHP line is in alignment with the opening in the **fitting ring**:

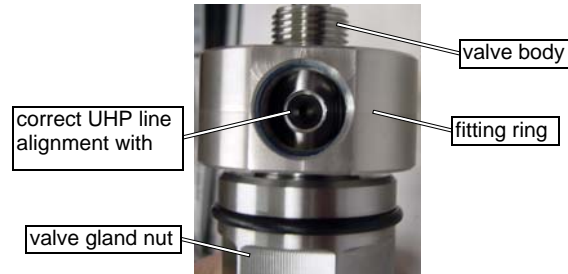

Figure 6-105: Align the UHP Line with the Opening in the Fitting Ring

2. Insert the **UHP input line** into the **fitting ring**. Ensure that the threads on the high-pressure line have been applied with anti-galling compound (Blue Goop) and that three threads are showing (see Three Thread Rule, page 6-6).



Figure 6-106: Applying Blue Goop and Ensuring Three Threads Show

3. Tighten the UHP input line using the 13/16" and 1" open end wrenches. Tightened to 50 ft-lb (no greater than 75 ft-lb. Refer to Figure 6-92.

Note: When tightening the gland nut, ensure that the ON/OFF valve remains square to the UHP line to eliminate stress on the UHP line.

4. Apply a small amount of anti-galling compound (Blue Goop) to the threads of the **valve body**.



Figure 6-107: Applying Blue Goop to the Valve Body Threads

5. Reinstall the **air actuator assembly**. Use the 1 1/8" crows foot to torque it at 250 in-lbs (28.2 N-m). Refer to Figure 6-90.
6. Re-attach the air line to the **air line fitting** on top of the **air actuator assembly**. Refer to Figure 6-89.

- Prior to use, remove the nozzle body (1" open end wrench) and jewel. Flush the system for at least 5 minutes using the **Test** button in **Make**. Select **High pump pressure**, **Water Only**, and click **Start Test**.

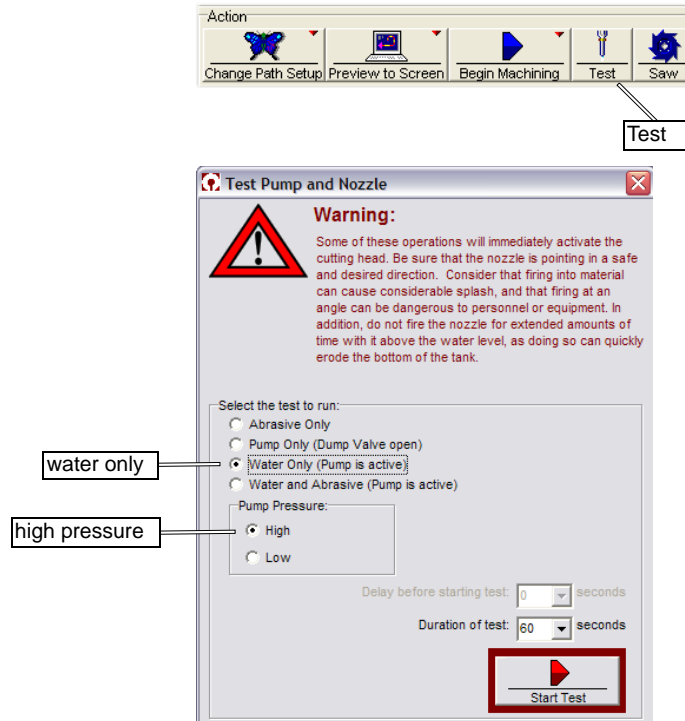

Figure 6-108: Flushing the System with Water Only at High Pressure

- After five minutes of flushing, re-install the nozzle body and jewel. Torque the Dual ON/OFF Assembly to the nozzle body at 30 - 40 ft-lb (40.6 - 54 N·m).
- Following installation, test nozzle operation using high-pressure water only. Refer to Figure 6-108.

Note: During a high pressure condition, check for visible leaking from the weep holes. If water leaking is present, the sealing is not complete between UHP fittings. Refer to Maintaining the High-pressure Plumbing System on page 6-3.

PC-based Controller Maintenance

Cleaning the OMAX Industrial Keyboard and Mouse

The OMAX keyboard and mouse are industrial components designed specifically to withstand exposure to the water and abrasive particles presented in an abrasivejet environment.

The OMAX mouse is water-resistant, but not water-proof. To prevent water from getting inside the LED lens, don't operate the mouse on a wet surface. If the mouse does get wet, spray it with a soft blast of air to help dry it out. If you get dirt on the bottom LED lens, use a clean Q-Tip to remove it.

The surface of the OMAX keyboard may be cleaned by brushing off the abrasive or wiping it clean using a soft rag lightly dipped in mild soap and water. When cleaning, always unplug the keyboard first and, if cleaning with water, prevent the water from entering the disconnected keyboard connector. Wipe the keyboard dry using a dry cloth, or allow it to dry in room air. When finished, be sure to reconnect the keyboard cable.

Cleaning the LCD Monitor Screen

Do not use a glass cleaner (Windex®, ammonia based, etc.) to clean an LCD monitor screen. It can damage the screen surface. The screen should be wiped off using a lint-free cloth. To remove any

particles or stains from an LCD screen, ensure that the monitor is first turned OFF. Gently wipe its surface using a lint-free cloth dampened with a small amount of distilled water.

Note: *Distilled water shouldn't leave streaks behind after drying.*

Replacing the Cabinet Air Filter

Beneath the OMAX Controller is an air filter (Figure 2-7) on the intake fan that prevents the controller cabinet from overheating. This filter blocks room dust and dirt from entering the computer along with the cooling air. Once this filter becomes plugged, air flow into the controller is restricted, causing the computer and associated PC-based controller components to overheat. Under normal shop conditions, you should clean or change this air filter every three months. If your OMAX is operating in an excessively dusty environment, check the filter at least monthly. Checking it should become part of your routine maintenance program. This filter is an easily obtained automobile air filter (Fram CA 327 or equivalent).

Replacing the CMOS Battery

A small, coin-sized battery in your computer powers the PC's CMOS memory. It's important to include changing this battery in your long-term maintenance schedule. If your battery fails and your CMOS memory stops running, the computer will reset its BIOS settings to their default values. Fortunately, CMOS batteries typically can last for 5-10 years.



Figure 6-109: Typical CMOS Lithium Battery

The role of the CMOS battery

The BIOS is the program that starts a computer up, and the CMOS memory is where the BIOS stores the date, time, and system configuration details needed to start the computer. The computer's CMOS memory is always running. Even when the computer is "turned OFF," a small amount of current still runs through the PC. This current is responsible for maintaining the CMOS settings. When the power to the OMAX is turned OFF at the power source, the flow of current to the PC stops. That's when the CMOS battery takes over; the CMOS always needs a power source.

What happens when the CMOS battery fails

If the battery fails and the computer isn't receiving power from an electrical outlet, the CMOS memory quits and important BIOS settings are lost. When lost, the date and time settings reset to the manufacturer's date and time which is usually years from the current date and time. Because the registration for the OMAX software is date and time-dependant, it's especially important for OMAX users to make sure the CMOS always maintains a power source. Should the BIOS settings be lost, and your computer loses track of the correct date and time, your OMAX software becomes unregistered. In addition, some hardware built into the motherboard may become disabled due to the BIOS default settings.

Clues to a CMOS battery failure

According to Dell Support, the Windows XP Pro computers informs you with a text warning when CMOS battery power is low; this message displays during the initial boot sequence. This warning should provide enough time to replace the battery. If the battery is dead, all is not lost. The computer typically continues to boot from the hard drive installed in the computer. But why wait for a warning? Keep your hardware and software interface intact. Change the battery at least once every three years. Before you change the battery, please contact OMAX Customer Service for specific details.

Rebooting Windows

Microsoft Windows is a complicated operating systems. It manages all memory, disk reading and writing, and memory operations for every program that run on your computer.

The following guidelines will help minimize operating system problems:

- **Reboot Windows at least once a day**

Even if everything seems to be fine, reboot Windows at least once per day. If any memory problems have crept in, this will clear them.

- **If a program crashes, always restart Windows**

If any program behaves weirdly, or crashes, restart Windows. This clears out memory and makes sure that you start “fresh.” Once Windows becomes “confused,” it rarely fixes itself, and usually causes more problems.

- **Wait for Windows to finish booting**

Windows takes awhile to boot, and it may be tempting to get started before it's finished loading. This is a particular temptation with Windows XP, which displays the desktop up to one minute before it's actually finished loading everything. Wait until all disk activity is done before you launch any programs. You can also monitor activity in Windows XP using Task Manager (press Ctrl+Alt+Del) to check when CPU usage has dropped to zero.

Running the Disk Defragmenter Utility

When Windows saves a file on the hard drive, it stores this file in whatever memory locations are currently available. If, for example, a five megabyte file is saved, and there are only five one megabyte spaces available, this file would be broken down and stored in five different locations. As time goes by, the available storage spaces could even get smaller and smaller, forcing Windows to use smaller and smaller storage locations. Soon, this original five megabyte file becomes stored in hundreds of individual locations. Reassembling a file stored in this fashion takes a lot longer than it would for a file stored in a single memory location. In extreme cases, it may take several minutes to load a large file that has become “fragmented” into hundreds of separate pieces.

A disk defragmenter utility goes through the entire hard drive, combining all the file fragments into a single location which greatly speeds up the file assembly process.

To run the Windows Disk Defragmenter utility:

1. Click the **Start** icon.
2. Select **All Programs**.
3. Select **Accessories**.
4. Select **System Tools**.
5. Select **Disk Defragmenter**.
6. Select the drive to defrag and click **Defragment**.

Note: *Depending on how badly fragmented your hard drive is, it can take anywhere from ten minutes to a few hours to finish. Do not run other programs while it is working – just leave it alone until finished. This is a good utility to run overnight, or while you're at lunch.*

Upgrading Your OMAX Software

The OMAX Technology Guarantee entitles you, as the original owner, to free OMAX software upgrades for the life of your machine. You may acquire as many software seats as needed for off-line programming. Always keep your OMAX software up-to-date. Software updates are always free and available from the OMAX Customer Support Web site at www.omax.com/support. To gain access, you need a user name and password, which you can obtain by contacting OMAX Technical Support.

New versions of the software are typically posted once or twice a year and will automatically overwrite your existing version when installed.

Caution: *You should not uninstall the current version of your OMAX software before successfully installing its replacement. You may lose valuable history and settings files, causing your OMAX machine to make substandard parts. Simply run the installation program for the new software to install it.*

You can also use the OMAX technical support web site to download "beta" versions of the software. OMAX Beta Software is still being tested, but may contain useful features. This same support site contains instructional videos and updated technical information. You are encouraged to regularly visit this support web site to stay up-to-date on your OMAX equipment.

Note: *A user name and password are required to access the OMAX technical support site. To set up a user account, contact OMAX Customer Service at 1-800-298-4036.*

Caution: *Before upgrading your OMAX software:*

- ***Do not uninstall your existing OMAX software! If you do, you may lose important machine and material settings as well as history files.***
- ***Always reboot Windows before installing software updates. This ensures that existing software copies are not running and Windows is properly initialized.***
- ***After rebooting Windows, do not run other programs prior to installing your OMAX software update. Other programs could conflict with the software installer.***
- ***Do not change the suggested installation settings. In particular, you should use the suggested installation location unless you have a good reason not to. If you don't use the default settings, future upgrades must be installed to the same non-standard directory to work correctly.***
- ***If you are upgrading a computer connected to an OMAX, be sure to shut down the computer and turn it OFF after the installation is completed (you will be reminded to do this by the install program). Otherwise, the software may not correctly control the OMAX.***

Troubleshooting the OMAX Table

This chapter provides information for servicing a JetMachining Centers' high-pressure plumbing. Troubleshooting procedures are also provided that are useful when analyzing performance issue that may occur during operation of your OMAX equipment.

WARNING! *All service activities must be performed by OMAX qualified personnel.*

Troubleshooting the OMAX JetMachining Center

The following lists most problems encountered with OMAX operation. Possible causes for each problem are provided with the most likely causes listed first. If you continue having a problem with your OMAX after following these procedures, contact OMAX Customer Service.

Problems

Refer to Solutions on page 7-4 to match a Corrective Action number listed below with the steps suggested to correct specific problems.

Condition and Possible Causes	Corrective Actions
Abrasivejet Nozzle Doesn't Move	
The Emergency Stop button was pressed.	1
A soft limit has been reached.	2
A babysit condition was triggered.	3
Wires or connections in the computer may have become loose.	4
Servo motors stalled.	5
Machine stops running with no messages and unable to close <i>Make</i> .	6
Parts are Too Short, or Flat Spots Appear When Cutting Curves	
The part was not held firmly enough.	7
The OMAX is reaching its hardware limits.	8
Home Position or Soft Limits are Lost	
The OMAX reached its hardware limits.	8
Wires or connections inside the controller may have loosened.	4
Poor Surface Finish	
Setup values in <i>Make</i> are not consistent with the actual physical values.	9
Standoff height is not set correctly.	10
Jet stream is too wide.	11
An abrasive other than garnet is being used and the "Abrasive Index" value was not changed to compensate for its lesser cutting ability. Refer to "Pump and Nozzle Configuration" in the OMAX interactive reference (OIR) for a list of abrasive index values to be used when cutting with abrasives other than garnet.	12
The mixing tube has worn excessively and is no longer capable of producing the required jet stream.	13
The jewel that forms the jet is chipped, dirty, or out-of-tolerance.	14

The abrasive flow has stopped or has been reduced by dirt or wet abrasive.	15
The high-pressure water pump is not delivering the pressure called for in the setup screen.	16
Holes Too Large and Undersized Parts	
The tool offset is set incorrectly	17
Tool offset is on the wrong side of the path.	18
Excessive Taper on Part Edges	
The cut was made with the quality value set too low.	19
The standoff between the abrasivejet nozzle and the material is excessive.	20
Setup values in Make are not consistent with the actual physical requirements.	9
An abrasive other than garnet is being used and the "Abrasive Index" value was not changed to compensate for its lesser cutting ability	12
The mixing tube is worn and unable to form a perfect jet stream.	13
The jewel that forms the jet is chipped, dirty or out of tolerance.	14
Holes are Not Round	
The cutting material is not securely fixtured.	7
The jet is elliptical rather than round due to wear in the mixing tube or a slightly imperfect orifice.	14
Abrasivejet Not Piercing Material	
Setup values entered in Make are not consistent with the actual physical requirements.	9
An abrasive other than the recommended garnet is being used.	12
The standoff between the abrasivejet nozzle and the material being cut is too high.	20
The abrasive flow is stopped or has been reduced by the presence of dirt or wet abrasive.	15
The mixing tube has worn excessively and is unable to form a perfect jet.	13
The jewel that forms the jet is chipped, dirty or out of tolerance.	14
The pump is not delivering the pressure specified in the setup screen.	16
Abrasivejet Quit Cutting	
The abrasive flow is stopped or has been reduced by the presence of dirt or wet abrasive.	15
The mixing tube in the abrasivejet nozzle is plugged.	21
The jewel orifice is plugged with foreign material.	22
The pump is not delivering the pressure specified.	16
80160 Not Cutting Square Parts	
The Y-axis is no longer exactly perpendicular to the X-axis.	23
Accuracy Errors	
The material being cut is improperly secured.	24
The nozzle is inadequately secured.	25
The material being cut has internal stresses.	26
Temperature caused the material to expand.	27
The nozzle and material collided.	28
The nozzle is worn out-of-round.	29
Water is Forced Up the Abrasive Tube	

Nozzle body is loose.	25
The ON/OFF valve is leaking.	34
The mixing tube in the abrasivejet nozzle is plugged.	21
The inlet body or valve body is damaged.	30
The standoff distance is so small that the nozzle is plugged by the work piece before it starts cutting and water is deflected to the abrasive tube.	20
The high-pressure pump is not delivering the pressure called for in the setup screen.	16
The Jet Looks Wide and Fuzzy	
The jewel that forms the jet is chipped, dirty or out of tolerance.	14
The mixing tube is worn and unable to form a perfect jet stream	13
No Abrasive Flow	
The abrasive flow is stopped or has been reduced by the presence of dirt or wet abrasive.	15
The standoff distance is so narrow that the nozzle is plugged by the work piece before it starts cutting and water is forced up the abrasive tube.	19
The shop air pressure is insufficient to open the abrasive valve.	27
No Abrasive Flowing from the Abrasive Tube	
The abrasive flow is stopped or has been reduced by the presence of dirt or wet abrasive.	15
The standoff distance is so low that the nozzle is plugged by the work piece before it starts cutting and water is deflected to the abrasive tube	20
The shop air pressure is insufficient to open the abrasive valve	31
Warped Material	32
Clogged Mixing Tube	33
Leaky ON/OFF Valve	34
Abrasive Material Pours Out the Top of the Abrasive Tube	
The abrasive flow is stopped or has been reduced by the presence of dirt or wet abrasive.	15
The standoff distance is so low that the nozzle is plugged by the work piece before it starts cutting and water is deflected to the abrasive tube	20
Foreign material in the water line has plugged the jewel.	22
Water Spurts Out of the Tank	
The part is positioned on top of a slat, causing the jet stream to reflect upwards.	35
Abrasive Piles Up on the Work Piece	
The accumulation of abrasive silt at the bottom of the tank is excessive.	36
The Table Has an Unpleasant Odor	
Excessive bacteria growth in the tank.	37
Keyboard or Mouse Fail to Work	
No mouse movement.	38
Keyboard not responding.	39
Blue Screen Errors	
Loose USB cable. If the USB cable is unplugged while <i>Make</i> is running, the monitor will blue-screen.	40
Corrupt device driver	41
“Babysit Triggered” Message	

Low air pressure	31, 3
Fault in a servo circuit	42, 3
Pause button pressed	43, 3
Access Control Circuit triggered. (European Market only)	44, 3

Solutions

Refer to Problems page 7-1 for a list of problems encountered.

Corrective Action	Description
1	Turn the Emergency Stop OFF and then ON again and reset the homes and soft limits. Because your soft limits may be incorrect after using the emergency stop button, you can disable them by entering zero for the X and Y- limits
2	Use the jog buttons to move up and down (if you have hit a soft limit, only one of those directions will be blocked). Auto homing should recover the soft limits. If the soft limits are lost, refer to the help menu in Make for instructions on setting new limits. Note: You may want to reset your soft limits if they are too small.
3	The OMAX has several switches monitoring machine operation. When any of these switches are triggered, the abrasivejet nozzle immediately stops operation and no longer continues machining or is able to be moved. When an attempt is made to restart operation, a "Babysit Triggered" error message appears. To recover from a babysit condition, first, correct the cause that triggered the babysit, then hold down the Override switch on the controller front panel. Caution: Ensure that you know what triggered the condition before attempting a babysit override. Continuing to operate the OMAX by overriding these switches may damage the OMAX. If you are unable to determine what triggered a babysit condition, contact OMAX Customer Support.
4	Turn OFF the power and open the back of the electrical cabinet. Test each connection and make sure the connectors are firmly seated. Close the cabinet, turn the power back ON and try again.
5	This condition could be caused by: <ul style="list-style-type: none"> • Nozzle collision • Mechanical issue (sticky ball screw, etc.) • Incorrect servo tuning • Incorrect speed, acceleration, or jerk setting Cycle power to the machine. Return the nozzle to Path Start Home. If Path Start Home is lost, auto homing should recover Path Start Home.
6	Severe noise or noise spike on USB cable caused the device driver to lock. Rebooting the PC is necessary.
7	The part moved during the cutting due to nozzle drag or upwelling of the water beneath the part. Make sure the part is securely fixtured. This is the most common reason for scrap parts.
8	Move the work piece toward the table's center. Set soft limits that allow you to be warned before hardware limits are reached. Note: Auto Homing should recover all positioning for the waterjet, including soft limits.
9	Check that the following data is correctly entered for setup in Make : <ul style="list-style-type: none"> • Machineability—thickness Click Setup in Make and choose <i>Pump and Nozzle Settings/Pump and Nozzle Configuration</i> and verify that the following parameters are set correctly: • Water pressure • Orifice diameter • Mixing tube diameter • Abrasive flow rate
10	Click Setup in Make and choose <i>Pump and Nozzle Settings/Motion</i> and verify the standoff is set at a height of 0.040 - 0.080" (0.1 - 0.2 cm).

<p>11</p>	<p>Raise the nozzle approximately 4" (10.2 cm) and initiate a high pressure, water-only test. Ensure that the jet stream is narrow and sharp. If the jet stream is wide, replace the orifice jewel assembly, the last chance filter, and inspect the mixing tube. If the mixing tube's outlet hole shows elliptical wear, or the diameter has grown approximately 0.005" (0.127 mm), it is recommended that the mixing tube also be replaced.</p> <div data-bbox="743 281 1052 485" style="text-align: center;"> </div>
<p>12</p>	<p>Other abrasives do not typically cut as well as garnet and require that the abrasive index value in the Pump and Nozzle Configuration screen be adjusted. OMAX recommends garnet as the abrasive because it provides a good cutting rate with relatively low mixing tube wear. Garnet is also non-hazardous and is easily disposed. Other abrasives may increase mixing tube wear and be a disposal hazard.</p> <p>Warning! Never use silica sand as a cutting abrasive. Fine silica dust inhaled during the cutting process can lead to silicosis, a serious lung disease. Silicosis is a type of pneumoconiosis, which includes black lung disease.</p>
<p>13</p>	<p>If changing the jewel does not improve the quality of the jet, then the mixing tube needs to be checked and possibly replaced. Wear occurs first at the inlet with a conical wear zone growing toward the exit end. Measure the tube bore at the two ends using a drill or gauge pin. When the outlet has grown by 0.005" (0.13 mm), the mixing tube is near the end of its useful life for precise cutting.</p>
<p>14</p>	<p>Replace the jewel and the jewel holder.</p>
<p>15</p>	<p>Disassemble the plugged items and blow them clean and dry using an air hose.</p>
<p>16</p>	<p>Measure the pressure and if it is below specification, follow the directions in your pump service and maintenance manual to troubleshoot the problem.</p>
<p>17</p>	<p>If not enough material is being removed (hole too small or part too large), decrease the tool offset by half the dimensional error observed. If too much material is being removed, increase the offset by half the dimensional error. By measuring parts as they are finished, you can monitor the wear of the mixing tube and periodically reset the tool offset to achieve more precise parts.</p>
<p>18</p>	<p>Switch the lead in and lead out and then use the Generate Tool Path command from Layout to order the part again. You can check your tool offset using Preview to Screen in Make.</p>
<p>19</p>	<p>A Quality of 1 will just barely pierce the material and usually has significant taper. Both taper and surface finish should improve as the Quality number is raised (takes longer to cut the part). Remember that different Qualities can be set to cut different portions of the same part.</p>
<p>20</p>	<p>The standoff should be between 0.040" (1.0 mm) and 0.050" (1.3 mm) for best results.</p>
<p>21</p>	<p>Use the software in Make to turn the water ON and OFF trying to dislodge the plug. If this does not work, you may need to disassemble the nozzle for cleaning, or replacing the mixing tube.</p>
<p>22</p>	<p>Remove the nozzle and flush the lines. Replace the jewel with a new one.</p>
<p>23</p>	<p>Square the Y-axis bridge against the hard stops on the right controller side of the machine. You should resquare (home) the Y-axis whenever:</p> <ul style="list-style-type: none"> • The X-axis drive motor faults. • The Y-axis bridge crashes.
<p>24</p>	<p>Always have firm anchoring in X,Y, and Z directions, even if the material is heavy. Never anchor directly to slats. These are insecure and can easy vibrate.</p>
<p>25</p>	<p>Ensure that the nozzle is firmly attached.</p>
<p>26</p>	<p>Material stresses can cause huge part errors. As the part is machined, these stresses can cause the material to move and stretch.</p>
<p>27</p>	<p>The material is stored in a different temperature than the tank water and changes size during or after cutting.</p>
<p>28</p>	<p>Avoid traversing over previously cut features. Watch for parts or slugs that tip or float around.</p>

29	Uneven wear on the nozzle can result in a square box being cut as a rectangle, or similar errors of up to approximately 0.010" (0.0254 cm).
30	Inspect both parts for signs of a crack. Replace part whenever damage is noted.
31	The abrasive valve requires 70 to 95 psi (5 to 7 bars) shop air.
32	Verify that the standoff height is at least 0.040" - 0.080" (0.1 - 0.2 cm) above the material being cut.
33	Use the high pressure water test to dislodge the clog. If this does not work, remove the mixing tube and clean it in an ultrasonic cleaner.
34	Contact OMAX Technical Support for details on troubleshooting a leaky ON/OFF valve assembly. Refer to Rebuilding the Dual ON/OFF Valve, page 6-52, for repair instructions.
35	Contain the spray using the muff. A disc cut from a 2" (5 cm) thick sponge makes an effective muff.
36	Remove the slats and clean out the tank.
37	Check the floating chlorine dispenser to ensure it still contains the bacteria-killing pool chemicals supplied with the OMAX.
38	Verify that the mouse cable has not worked itself loose and is fully plugged into the USB port at the rear of the PC. Also, unplug the cable and inspect the USB connector for bent or damaged pins. Verify that the optical sensor on the bottom of the mouse is not blocked with dirt buildup. Try rebooting the PC to see if this corrects the problem. Swap the mouse with a known good mouse to see if the problem goes away, verifying that mouse itself is at fault.
39	Verify that the keyboard cable has not worked itself loose and is fully plugged into the USB port at the rear of the PC. Also, unplug the cable and inspect the USB connector for bent or damaged pins. Try rebooting the PC to see if corrects the problem. Swap the keyboard with a known good keyboard to see if the problem goes away, verifying that keyboard itself is at fault.
40	Ensure that the USB cable is plugged in adequately. Reboot the PC.
41	Simply re-installing OMAX software can fix this. Be sure to fully power down the controller, wait 10 or more seconds, then turn it back ON for all driver related changes to refresh.
42	Check the fault LEDs on the controller back door to identify which axis faulted (Figure 2-5). Check the faulted servo card's LED status indicators. Refer to figures that follow for card locations. LED indicators for both Teknic and Teknic Eclipse Servo Drives: <ul style="list-style-type: none"> • Green LED ON steady or blinking at fast rate - normal operation • No LEDs lit - power failure • Red LED steady ON - blown fuse • Green LED slowly flashing - servo fault • Green LED ON steady - servo not enabled Whenever any of the above faults are indicated, contact Technical Support.
43	Release Pause button.
44	Re-arm the Access Control Circuit.

Refer to the OMAX Interactive Reference (OIR) that comes with your OMAX software for comprehensive information on troubleshooting software issues.



Figure 7-1: Servo Card Locations for Y and X-axis for Bridge-style Table

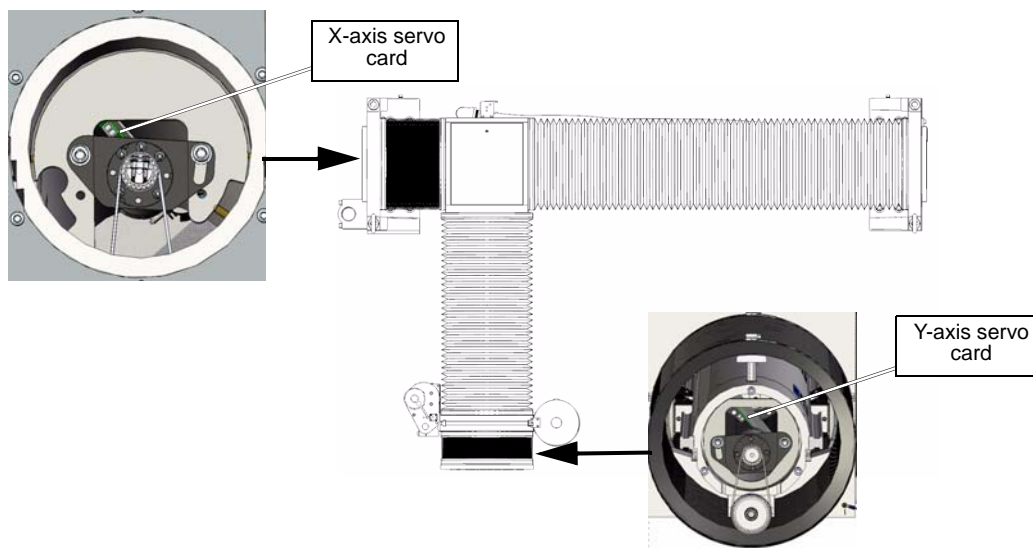

Figure 7-2: Servo Card Locations for X and Y-axis 2626, 2626/xp, 2652, 5555, 55100 Servo Motors

Correcting Water Leaks in the Nozzle Assembly

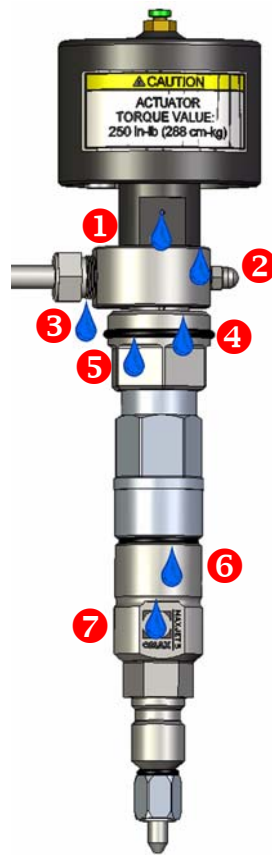

Figure 7-3: Sources of Water Leaks in the Nozzle Assembly

Troubleshooting Leaks in the Nozzle Assembly:
(refer to Figures 7-3 above)

Leak Point	Leak/Other Point Description	Suspected Causes	Recommended Action
1	air actuator weep hole	leaky seal	Verify air actuator torqued at 250 in-lb (28.2 N·m); replace seal
2	between air actuator and fitting ring	leaky seal	replace seal
3	between fitting ring and gland nut	cracked body, bad UHP tubing, loose gland nut	replace defective component; verify gland nut torqued at 60 ft-lb (68 N·m)
4	between fitting ring and valve gland nut	cracked body; loose nut	replace defective component; tighten nut
5	valve body	cracked inlet or valve body; loose nut	replace defective component; tighten nut
6	between nozzle body and inlet body	cracked inlet or nozzle body; leaky O-ring	replace defective component
7	weep hole on nozzle body	chipped jewel, cracked body, leaky seal	replace defective component

Correcting Water Leaks in the ON/OFF Valve

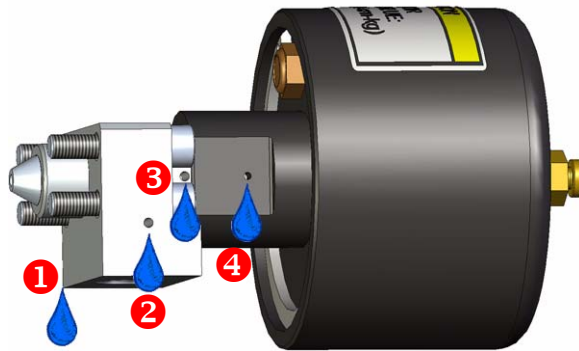

Figure 7-4: Sources of Water Leaks in the ON/OFF Valve

Troubleshooting Leaks in the ON/OFF Valve:
(refer to Figure 7-4)

Leak Point	Leak/Other Point Description	Suspected Causes	Recommended Action
1	Leaking around the plate and not from any weep hole	cracked inlet or valve body; loose bolts	replace defective component; tighten loose bolts
2	weep hole	UHP adapter to body leak; cracked body	replace defective component
3	weep hole	Cracked body or leaky seal	replace defective component
4	weep hole	leaky UHP seal	replace leaky seal



Troubleshooting the OMAX Pump

This section provides troubleshooting procedures for the OMAX pump. Most pump operations are controlled and monitored via the OMAX keypad. All fault messages, except those related specifically to the Variable Frequency Drive (VFD), appear on the OMAX keypad display. The VFD provides power, protection, and speed control for the pump motor. If the VFD itself faults for whatever reason, the message “Variable Drive Fault” appears on the OMAX Keypad.

If you are unable to determine and correct a pump problem by following these procedures, contact OMAX Customer Service for assistance.

WARNING! *All electrical and maintenance work described in this chapter should be undertaken only by qualified service personnel. The safety instructions presented in the first chapter of this Following each problem is a list of possible causes. If you continue to have problems with your OMAX pump after following these procedures, contact OMAX Customer Service by telephone, or by fax. Refer to chapter 9, Customer Service.*

Keypad Display Messages

Normal Operation Messages

When the pump is operating normally, the keypad displays these four lines of text:

Water Pres	xx.x KSI	pump output pressure in Ksi
High PreSet	xxxx RPM	preset drive motor high RPM
Low PreSet	xxxx RPM	preset drive motor low RPM
RunTime	xxx HRS	accumulative number of pump run hours

Pump Fault Messages

All fault messages, except those related specifically to the Variable Frequency Drive (VFD), appear on the keypad display. When a fault condition during pump operation occurs, the pump shuts down with one or more of the following messages appearing in the first three lines of the keypad display.

Note: *The fourth line on the OMAX keypad display always monitors the cumulative pump hours. The number of these hours is not resettable.*

Charge Pressure Low

Water pressure immediately downstream of the water filters is less than 50 psi.

Charging Pump Contactor

The charge pump contactor did not close or opened for some reason. It generally occurs along with the message “Charge Pressure Low.”

Dead Head

Reported when pump output pressure equals or exceeds 60,000 psi.

Variable Drive Fault

There is an issue with the Variable Frequency Drive.



Figure 8-1: Example of Pump Fault Condition Appearing on Keypad Display

- Before the pump can be restarted, the fault condition must be cleared from the pump control by pressing the RESET button. The LED next to the RESET button goes out and the LED next to the STOP button lights.
- Once the fault condition has been reset, the pump is again enabled and may be restarted.
- If all conditions triggering the fault have not been corrected, the uncorrected fault(s) reoccurs, the pump again shuts down, and a fault message reappears on the display.

Fault Message – “Charge Pressure Low”

This fault message appears on the OMAX pump's display when the water pressure at switch (S1) immediately downstream of the water filters is less than 50 psi.

1. Verify that the charge pump's ON/OFF switch is in the ON position.
2. Check the water level in the white water tank (Figure 5-53) for an adequate water supply. Verify that the water source is turned ON, and the inlet screen to the charge pump in the white water tank is not blocked.
3. Check the pressure gauges before and after the water filters. If the downstream gauge (final filter) exceeds 50 psi (typically 12- psi), the pressure switch (S1) may be defective. If the upstream gauge (pre-filter) does not exceed approximately 70 psi, the charge pump may be partially plugged or defective.
4. Verify that all air has been bled from the water filters.
5. Check that the water filters are not plugged or damaged. If the pressure difference between the two pressure gauges is more than 20 psi, replace the filter cartridges. See Changing Water Filter Cartridges, page 5-34.
6. Verify that the water pressure switch is operating properly. This switch must be closed for the pump to operate. Operation of the switch may be checked by using a voltmeter to see if the switch closes when the pump is running and sufficient pressure is indicated on the downstream pressure gauge on the filters. If the switch is closed, the voltage on the DIN rail between wires 2181 (brown) and 2440 (white) should show 0 VDC, or very little voltage. If the switch does not close, the voltage should be about 24 VDC. Inspect the wire connections on the switch, ensuring the plug connector has not come loose. If the switch appears to be faulty, contact OMAX customer service.

Fault Message – “Charging Pump Contactor”

This message appears on the OMAX pump's display when the charge pump contactor (C1) did not close as expected. It generally appears along with the message “Charge Pressure Low.”

1. Verify that the charge pump manual ON/OFF switch is in its ON position.
2. Check the water level in the white water tank (Figure 5-53) for an adequate water supply. Verify that the water source is turned ON, and the inlet to the charge pump in the water tank is not blocked.
3. Check that the ribbon cable between the display and keypad is not loose and/or defective. Ensure that the connector is fitted tightly onto the keypad and display. If red LEDs are lit on the keypad, and the connector is tightly fitted against the keypad and display, the ribbon cable may be bad. Before replacing the ribbon cable, first inspect the 34-pin cable on the keypad. See Figure 8-2, Keypad Ribbon Cable and 34-Pin Connector Location on page 8-3.

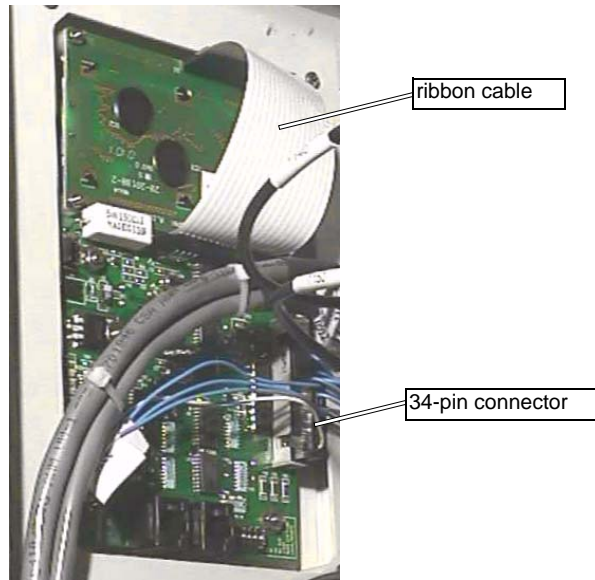

Figure 8-2: Keypad Ribbon Cable and 34-Pin Connector Location

4. Check that the 34-pin connector cable is not loose and/or defective. Ensure that the connector is fitted tightly onto the keypad by disengaging and then re-engaging the connector; it should feel snug. If that does not correct the problem, detach the 34-pin cable from the keypad and visually inspect the female connector, ensuring all pins are fully locked into the housing. See Figure 8-2, Keypad Ribbon Cable and 34-Pin Connector Location on page 8-3.

Caution: *If a pin is not locked into the housing, gently pull it out of the connector, noting what socket it fits in. The pin has a locking tab that should be bent outward so when correctly inserted into the housing, the tab “locks” into place. The locking tab should always face outward from the housing. When correctly installed, the pin cannot be withdrawn from the housing without first pushing the tab against its pin.*

5. Check for a blown fuse (or no fuse) in the fuse holder on the DIN rail located directly below the 24 VDC power supply. When there is power from the 24 VDC power supply, the fuse holder's red LED lights to indicate a blown fuse. When blown, use an equivalent 0.5 Amp replacement. See Figure 8-3, 24 VDC Power Supply Fuse Location on page 8-3.

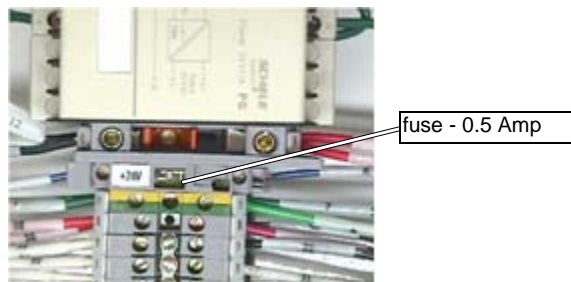

Figure 8-3: 24 VDC Power Supply Fuse Location

Note: *A box of 0.5 Amp fuses is supplied with every new pump unit, stored in a plastic container attached to the bottom of the enclosure.*

6. Tighten any loose wires on the input and/or output side of the 24 VDC power supply.

Note: *If the power supply's green LED fails to light, there is no 120 VAC being delivered, as measured across L and N. If 120 VAC is present, the power supply has failed and must be replaced.*

7. Check that a wire has not come loose on the contactor. Using a voltmeter, check for 120 VAC between wires 2130 and 1201 at terminals 1L1 and 3L2. Verify that these wires are tight and making good metal-to-metal contact at terminals 1L1 and 2T1. Follow these wires all the way to the charging pump. Check wires 2131 and 1201 between the contactor and the charge pump motor. Strip and/or tighten any wire that may be a problem.
8. Verify that 460 VAC $\pm 10\%$ (380 VAC $\pm 10\%$ International) is present across terminals L1, L2, and L3, located at the bottom of the DIN rail inside the electrical enclosure of the pump. If power is not present across these terminals, refer to "No AC Power at Pump Unit", page 8-6.

Fault Message – “Dead Head”

This message appears on the OMAX pump's display when pump output pressure equals or exceeds 60,000 psi. After determining the cause of the overpressure, also check the pressure safety valve on the pump to ensure it's not damaged.

1. Verify that the high-pressure orifice and nozzle are not plugged, or partially plugged.
2. Verify that the orifice in use is not too small, particularly if it has just been installed.
3. If equipped with dual ON/OFF valves, check that air is being supplied to the ON/OFF valves (70 - 80 lbs. of air pressure required).
4. Verify that the orifice in the “dumping” ON/OFF valve is not too small, or is not plugged, or partially plugged.
5. Check that none of the high-pressure tubing is blocked or plugged.

Fault Message – “Variable Drive Fault”

This message appears on the OMAX pump's display when there is a fault with the variable frequency drive (VFD). If a VFD fault occurs:

- The problem that created the fault must be corrected.
 - The RESET button on the OMAX pump keypad must be pressed to clear the fault condition; and
 - If the fault reoccurs, troubleshooting the cause of the fault must be resumed.
1. If a VFD fault message occurs on the OMAX keypad display, check the fault message reported on the ABB drive display panel inside the pump electrical enclosure.
 2. When a VFD fault stops the drive, the fault code number and fault description are displayed on the VFD display panel located inside the pump electrical enclosure.

Note: For faults not listed, refer to the ABB User's manual. If a VFD fault persists, contact OMAX Customer Service.

3. To restart the OMAX pump, the fault condition must be “cleared” by pressing the Reset button on the OMAX keypad. The display returns to the display present prior to the fault trip. If the condition that caused the VFD fault was not corrected, the VFD continues to fault, preventing operation of the pump unit.

General Pump Problems

Problems covered in this section include:

- Low or fluctuating pump output pressure (page 8-5)
- No AC power at pump unit (page 8-6)
- Pump does not start (page 8-6)
- No keypad display (page 8-7)
- Pump runs but display reads “0.3 KSI”, or “0 KSI” (page 8-9)
- Fuses F1/F2 **blowing** (page 8-8)
- Circuit breaker CB1 tripping (page 8-9)

Low or Fluctuating Pump Output Pressure

Caution: *Never run the OMAX pump once pressure at a given RPM for a given nozzle drops more than 2000-4000 psi. Continued operation with damaged check valve seats or failed dynamic seals can further damage components in the pump's wet end, resulting in higher rebuild costs.*

1. Check the high-pressure plumbing for leaks, loose fittings, or split tubing.
2. Verify that the water level in the white water tank (Figure 5-53) is sufficient, that the water source is turned ON, and the inlet filter to the charge pump in the white water tank is not blocked.
3. Check the pressure gauges on top of the water filters. Reduced output pump pressure can result from clogged filters. If the pressure difference between water filter pressure gauge readings is more than 20 psi, replace the filter cartridges (see Changing Water Filter Cartridges, page 5-34). If both gauges on top of the water filters show lower than normal pressure, clean the screen on the end of the charge pump suction inlet inside the pump water tank.

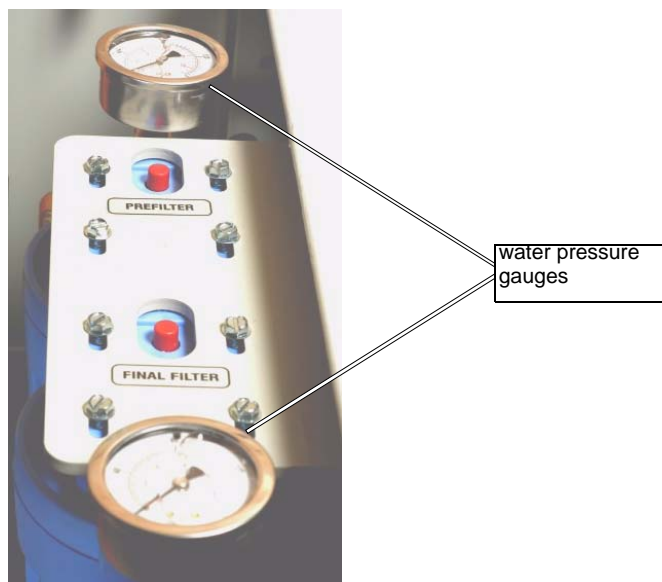

Figure 8-4: Pressure Gauges for Water Filters

4. Check the pressure safety valve for leakage. If the valve leaks more than 1 drop per minute, rebuild or replace the safety valve as soon as possible.

WARNING! *Never attempt to adjust the safety valve, doing so creates a safety hazard!*

5. Check for water leakage between the manifold and check valve bodies, and between the cylinders and check valve bodies (refer to Figure 8-8). If leaking, remove and disassemble the wet end, inspect and clean all parts, and replace seals.
6. Check the temperature of the high-pressure cylinders. If a cylinder is hot and no external leaks or excessive flow back to the water tank is observed, the check valve body on that cylinder may have a crack between the inlet and outlet passages. Remove and disassemble the wet end, inspect and clean all parts, and replace seals.
7. If the abrasivejet orifice is damaged or chipped, it may pass the full flow of the high-pressure pump without developing its rated pressure. Check by replacing with a new orifice.
8. Check the output pressure gauge (if so equipped) to determine if it registers low pressure, but the machine still cuts quality parts with the software set at high pressure. If this is the case, the gauge may be inaccurate or defective.

- While the high-pressure pump is running at high pressure in **Test** mode, check the cylinders and the three white hoses (Figure 5-53) that run into the white water tank for heat. Also, check if the hoses are expelling hot and/or pulsing water. This indicates worn high-pressure seals (dynamic) that must be replaced by rebuilding the pump wet end. If a hose has no water flow, check for a plugged orifice in the pump outlet manifold. When air bubbles are observed in the returning water, check for a leaky suction line.

Caution: *Do not run the OMAX pump once the pressure at a given RPM for a given nozzle drops more than 2000-4000 psi. Continued operation with damaged check valve seats or failed dynamic seals can result in further damage to components in the wet end and may result in higher rebuild costs.*

- If there is low pressure with high vibration, a plunger may be loose or broken. Immediately, power OFF the pump. Turn the pump by hand to locate the bad plunger. If a plunger is broken or scored, contact OMAX for a replacement plunger assembly. Replace all the high-pressure seals before reassembling the pump.

No AC Power at Pump Unit

- Have a certified electrician verify that AC power is available at the main power disconnect by measuring the voltage between all three legs.

WARNING! *It is the customer's responsibility to ensure that all components and conductors, as well as grounding and wiring methods, comply with the most recent version of the NEC, IEC or JIC, whichever is applicable, as well as all regional and local codes and standards. Wiring must be performed by a certified electrician and conform to national, state, and local requirements.*

- Check the fuses at the main power disconnect.
- Check that the main power is ON.
- Check that the ON/OFF switch on the pump unit is ON and that the ON/OFF switch on the controller is ON.
- Check that the E-stop switches on the pump unit and the computer controller are reset.
- Check that 460 VAC $\pm 10\%$ (380 or 415 VAC $\pm 10\%$ for international) is present on L1, L2, and L3 at the bottom of the DIN rail inside the pump control enclosure (refer to Figure 8-5).

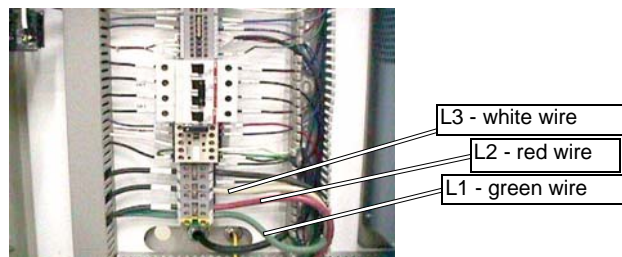

Figure 8-5: AC Power Legs L1, L2, and L3.

Note: *Power between the three legs L1, L2, and L3 can vary by up to 6% from the average of all three. A variation that exceeds more than 6% causes a phase unbalance VFD fault.*

Pump Does Not Start

- Check that the main power is ON.
- Check that the ON/OFF switch on the pump unit is ON.

3. Check that the E-stop switches are reset. The E-stop on the pump shuts down both the pump and X-Y table (if connected). Likewise, the E-stop on the Controller shuts down both the X-Y table and the pump. To reset either E-stop switch, simply pull it out.
4. Check the "FAULT" condition displayed on the OMAX keypad display. If the display indicates a fault (Figure 8-1), refer to the section of this document dealing with the specific fault. More than one fault may be reported. Usually, the fault that shut down the pump is the first reported and appears on the line of the display closest to the pump hours. After correcting the conditions that created the fault(s), press the reset button on the OMAX keypad to clear the display and re-enable the pump unit.
5. Check if the pump keypad display is lit. If it is not, go to "No Keypad Display."
6. Check the display on the VFD keypad inside the electrical enclosure. It should display the condition "REM" in the upper left corner of the display. If the VFD does not show "REM", press the LOC/REM button on the VFD display panel to put the drive into remote control mode (REM). In local mode (LOC) the drive does not respond to commands from the OMAX keypad, or from the OMAX controller. Refer to Figure 8-6.

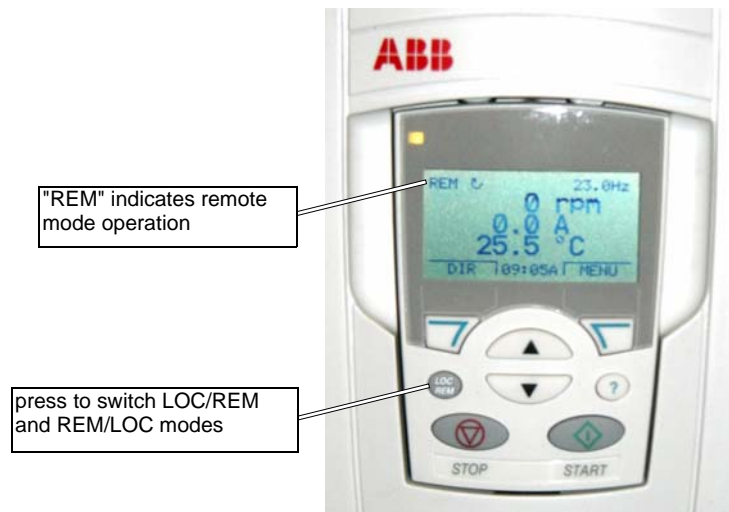

Figure 8-6: VFD Remote (REM) Mode

No Keypad Display

The display on the OMAX Keypad is blank and/or no red LED's next to the buttons are lit.

1. Check that no E-stop switches are engaged.
2. Check that the ON/OFF switch on both the controller and pump unit are in their ON positions.
3. Verify that 460 VAC $\pm 10\%$ (380 or 415 VAC $\pm 10\%$ International) is present across terminals L1, L2, and L3 located at the bottom of the DIN Rail inside the electrical enclosure of the pump (Figure 8-5). If no power is present across these terminals, see "No AC Power at Pump Unit" on page 8-6.
4. Check that 460 VAC $\pm 10\%$ (380 or 415 VAC $\pm 10\%$ International) is present across the primary terminals H1 and H4 (H3 for international units) of the 2KVA transformer.
5. Check that 110 VAC is present at the output, secondary terminals X1 and X3 or X4 of the 2KVA transformer.
6. Check that the 24 VDC power supply located on the DIN rail inside the pump electrical enclosure is producing 24 VDC by checking DC voltage between L+ and ground on the right hand side.
7. Check for and tighten any loose wires on the input and/or output side of the 24 VDC power supply.



Figure 8-7: 24 VDC Power Supply

Note: If the power supply's green LED is not lit, no 120 VAC is present as measured across terminals L and N on top of the 24 VDC power supply. If 120 VAC is present, the power supply has failed and must be replaced.

8. Check for a blown fuse or no fuse in the fuse holder on the DIN rail located below the 24 VDC power supply. If there is power from the 24 VDC power supply and the fuse holder's red LED is lit, a blown fuse is indicated. See Figure 8-3, 24 VDC Power Supply Fuse Location on page 8-3.

Note: A box of 0.5 Amp replacement fuses is supplied with every new pump unit and is stored in a plastic container attached to the bottom of the enclosure.

9. Check that the 34-pin connector cable is not loose and/or defective. Ensure that the connector is fitted tightly onto the keypad by disengaging and then re-engaging the connector, it should feel snug. If that does not solve the problem detach the 34-pin cable from the keypad and visually inspect the female connector to make sure all of the female pins are fully locked into the housing. See Figure 8-2, Keypad Ribbon Cable and 34-Pin Connector Location on page 8-3.

Caution: If a pin is not locked into the housing gently pull it out of the connector being sure to note what socket it fits in. The pin has a locking tab that should be bent outward such that when correctly inserted into the housing the tab "locks" into place. The locking tab should always be outward facing from the housing in order to "lock" it in place. When correctly installed the pin cannot be withdrawn from the housing without first pushing the tab in tight against its pin.

10. Verify that the ribbon cable between the display and keypad is not loose. Ensure that the connector is fitted tightly onto the keypad and display. Ensure that the connector is properly fitted onto the correct pins. If red LEDs are lit on the keypad, and the connector is tightly fitted against the keypad and display, the ribbon cable may be bad. Before replacing the ribbon cable, also check the 34-pin connector on the keypad. See Figure 8-2, Keypad Ribbon Cable and 34-Pin Connector Location on page 8-3.
11. Check if Fuses F1 and/or F2 have blown.

Fuses F1/F2 Blowing

1. Check for loose wires between the 2 KVA transformer and circuit breakers. Tighten any found.
2. Determine if the transformer is defective by removing F1 and F2 and disconnecting the red wire, # 1170, from transformer terminal X1. Replace F1 with a good fuse. If F1 blows, the transformer is shorted and must be replaced.
3. Inspect the fan motors, keypad, transformer, DC power supply, etc., to see if any components have shorted or burned out. Replace any burned out components and re-test the fuses.

Circuit Breaker CB1 Tripping

Circuit breaker CB1 may trip when the charging pump is overloaded or the motor is shorted.

1. Check that the water filters are not plugged or damaged, causing the charge pump to overheat. Replace the filters if needed.
2. Check the charge pump water inlet in the water tank, ensuring the screen is not blocked or plugged.
3. Verify the charging pump is not jammed with foreign material, causing the motor to lock up. Remove the inlet and outlet water hoses on the charging pump to see if the circuit breaker continues to trip.
4. If no loose wires are found, the expected voltages are present on all terminals, and the circuit breaker continues to trip, the charge pump motor may need replacing.

Pump Runs but Display Reads “0.3 KSI”, or “0 KSI”

1. See if the 34-pin connector cable is loose and/or defective. Ensure that the connector is fitted tightly onto the keypad. If this does not solve the problem, detach the 34-pin cable from the keypad and visually inspect the female connector to ensure all of the female pins are fully locked into the housing.

Caution: *If a pin is not locked into the housing, gently pull it out of the connector, noting what socket it fits in. The pin has a locking tab that should be bent outward so when correctly inserted into the housing, the tab “locks” into place. The locking tab should always face outward from the housing. When correctly installed, the pin cannot be withdrawn from the housing without first pushing the tab against its pin.*

2. If the RPM is displayed correctly, but the displayed pressure is “0.3 KSI” or “0 KSI”, the pump control circuit board may not be receiving the pressure signal.
3. The pressure signal for OMAX pumps comes from the pressure transducer. A “T” appears on the OMAX display for the pressure reading if the transducer is connected and recognized by the pump control card. If the “T” is present but the pressure readout does not respond, the transducer may have failed, requiring replacement.
4. The transducer is a 4-20 ma transducer excited with 24 VDC from the 24 volt power supply located within the pump enclosure. Check the transducer itself, the connection to the transducer, a bulkhead connection through the back of the enclosure, a connection on the DIN rail inside the electrical enclosure, and the 34-pin connection on the pump control card.
 - a. Check that the transducer cable is connected securely to the bulkhead connector on the back of the pump electrical enclosure.
 - b. Check that the connector on the end of the transducer is securely attached to the transducer.
 - c. Loosen the screw holding the transducer connector and remove the connector from the end of the transducer. Refer to Figure 3-5 for pressure transducer location.
 - d. With a DC voltmeter, verify that the 24 VDC exciting voltage is present between terminal 1 and the ground terminal in the connector. If 24 VDC is not present, check and tighten all of the 2181 and 2182 terminals on the DIN rail of the enclosure. Check again for 24 VDC between terminals 1 and ground. Verify that the wires inside the enclosure are inserted correctly into the bulkhead connector through the back of the enclosure. There should be 24 VDC between the dark blue wire, 2181, on pin 2 at the bulkhead connector and any ground. The white/blue wire, 2182, should have continuity with any ground and should be connected on pin 4 of the bulkhead connector.
 - e. Check that the signal lead, wire 3030, is connected correctly on pin 2 of the bulkhead connector inside the enclosure.
 - f. Check and tighten the wire in terminals 3030 on both sides of the DIN rail.
 - g. Check the 34-pin connector to verify the pressure transducer signal appears on pin 26.

Correcting Water Leaks in the Wet End Assembly

This section identifies the location of possible water leaks in the wet end assembly (Figure 8-8) and suggests possible ways to correct them.

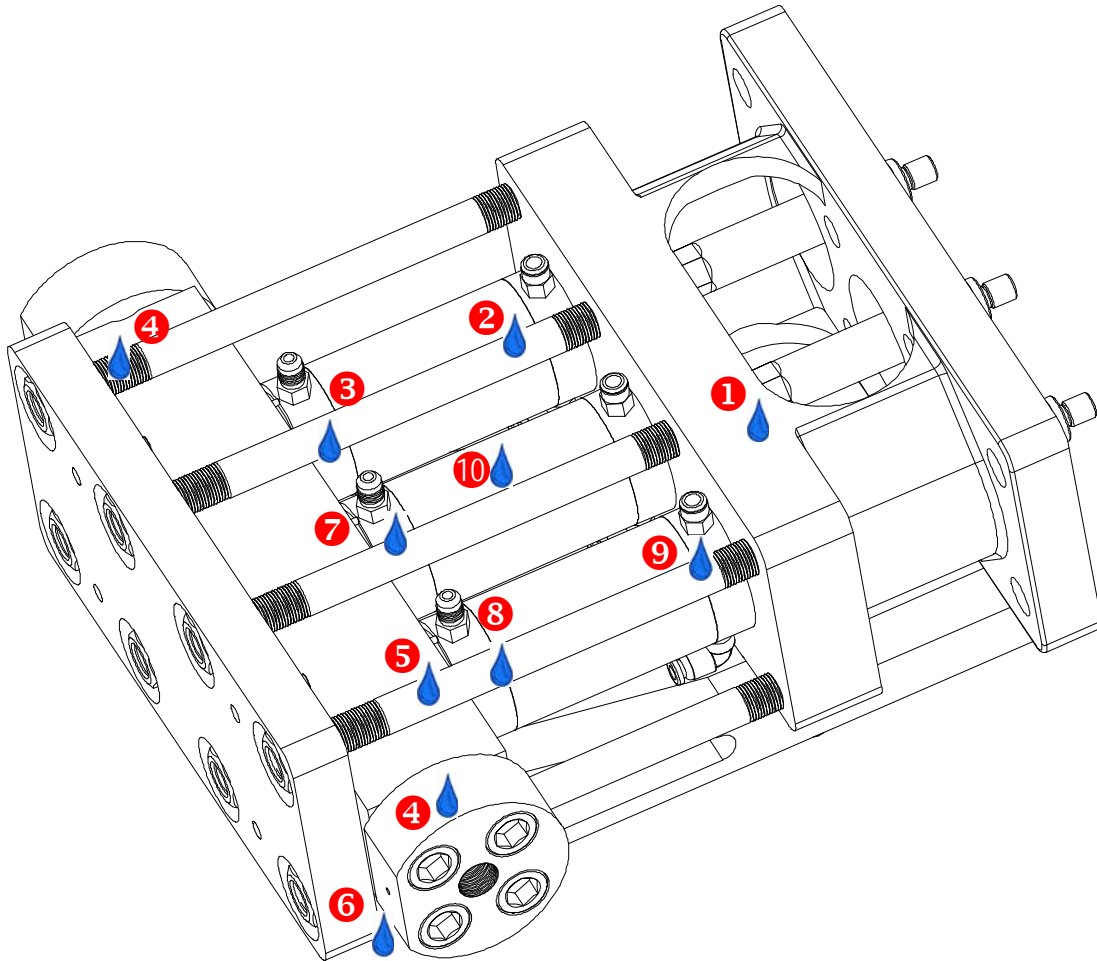

Figure 8-8: Sources of Water Leaks in the Wet End Assembly

Troubleshooting Leaks in the Pump Wet End Assembly: (refer to Figure 8-8)

Leak Point	Leak/Other Point Description	Suspected Cause	Recommended Action
1	Leak from Coolant Housing Seal	<ul style="list-style-type: none"> Coolant housing seal failure 	<ul style="list-style-type: none"> Replace coolant housing seal at next rebuild (this is coolant water and will not affect output pressure or pump life)
2	Leak(s) between Cylinder Body and Coolant Housing and/or between Cylinder Body and Check Valve Body (immediately after rebuild)	<ul style="list-style-type: none"> Insufficient torque on clamp plate nuts Insufficient anti-seize on clamp plate nuts 	<ul style="list-style-type: none"> Check torque on clamp plate nuts Apply fresh anti-seize to face of clamp plate nuts and threads and tighten to 175 ft-lbs
	Leak between the Cylinder and Coolant Housing	<ul style="list-style-type: none"> Cracked support ring Damage to the support ring that supports the ring seal Cracked cylinder 	<ul style="list-style-type: none"> Rebuild wet end assembly Inspect support rings for damage

Leak Point	Leak/Other Point Description	Suspected Cause	Recommended Action
3	Leak between Check Valve Body and Cylinder Body (immediately after rebuild)	<ul style="list-style-type: none"> Liquid displacer installed upside down 	<ul style="list-style-type: none"> Rebuild wet end assembly Inspect liquid displacer for damage and to ensure it is within tolerance before re-installing in the cylinder. If damaged, replace.
	Leak between the Check Valve Body and Cylinder	<ul style="list-style-type: none"> Cracked check valve body Cracked support ring Damage to support ring that supports the ring seal Cracked cylinder 	<ul style="list-style-type: none"> Rebuild wet end assembly Inspect support rings for damage Inspect check valve body for cracks and replace if cracked/damaged
4	Leak between Port Adapter and Manifold	<ul style="list-style-type: none"> Port adapter seal failure 	<ul style="list-style-type: none"> Replace port adapter seal
5	Leak between the Check Valve Body and the Manifold	<ul style="list-style-type: none"> Cracked check valve body Cracked manifold Seal is loose fit to stem of the check valve Damaged O-ring Extrusion of static ring seal 	<ul style="list-style-type: none"> Rebuild wet end assembly Inspect manifold and check valve body for damage/cracks Inspect O-rings and seals for excessive extrusion, fit, and/or damage
6	Leak from Weep Hole on Port Adapter	<ul style="list-style-type: none"> Possible damage to seal surface of the port adapter Possible damage to tubing seat 	<ul style="list-style-type: none"> Replace port adapter and seal Replace tubing
7	Warm Fitting on Check Valve	<ul style="list-style-type: none"> Damaged check valve inlet seat or ball <p>Note: There can be a damaged check valve inlet seat/ball with no noticeable heat.</p>	<ul style="list-style-type: none"> Rebuild wet end assembly Inspect for damaged check valve inlet seat or ball/ replace as needed
8	Warm Cylinder at Check Valve end	<ul style="list-style-type: none"> Damaged check valve outlet seat or ball 	<ul style="list-style-type: none"> Rebuild wet end assembly Inspect for damaged check valve outlet seat or ball/ replace as needed
9	Cylinder Body warm at Dynamic Seal end only	NORMAL	NONE
10	Sudden loss of pressure and Cylinder Body very warm or hot.	<ul style="list-style-type: none"> Cracked check valve body between the high- and low-pressure ports 	<ul style="list-style-type: none"> Rebuild wet end assembly Inspect for cracks/damage in the check valve body (internal cracking – inspect viewing through the low-pressure port – may require magnification)



Customer Service

This chapter explains how to reach OMAX Customer Service and provides instructions for the ordering and returning of parts.

Contacting OMAX Customer Service

OMAX Customer Service personnel can be reached throughout the workday for technical questions or ordering parts as follows:

8am – 8pm EST Monday through Friday
8am – 5pm EST Saturday and Sunday

Voice: 253-872-2300 x3 or 800-298-4036

International: 001 253-872-2300 x3 (phone); 001 253-872-7446 (fax)

Fax: 253-872-7446

E-mail: techsupport@omax.com

Ordering parts: parts@omax.com
international.parts@omax.com

Ordering Parts

OMAX parts can be ordered from Customer Service either by calling **800-298-4036** (international **01 253-872-2300 x3**), faxing **253-872-7446**, emailing **parts@omax.com**, or by accessing <http://shop.omax.com/home.php>.

When ordering parts, please provide the following information:

- Part name
- Part number
- Quantity needed
- Date required
- Your shipping information
- Purchase order number

Parts in stock are shipped the same day if an order is received by 2:30 pm PST. When not in stock, OMAX will provide an estimated shipment date. Same-day shipments for system-down emergencies can be accommodated if the requested part is in stock and the order received before 12:00 noon, Pacific Time.

Returning Parts

All parts returned to OMAX Corporation, for any reason, are handled according to the Returned Material Procedure described below. Return procedures vary, depending upon the reason for the return. The normal process for returned parts takes approximately ten working days once the part is received. All returned parts must have an RMA number and be returned within 30 days of the shipping date with proof of purchase to be considered for credit.

Returned Material Procedures

The following procedures are used by OMAX Corporation to handle part returns. OMAX issues credit for returned parts if received in their original condition, or had failed under conditions covered by the OMAX warranty.

Please follow these steps when returning parts:

1. Contact the Customer Service Department to obtain a Return Material Authorization number (RMA).
2. Please provide the following information:
 - Your company name and address
 - Your name and telephone number
 - OMAX sales order number
 - Original purchase order number
 - Itemized list of all parts being returned, including quantity, part number, and description
 - Reason for return (defective, ordered in error, repair, etc.)
 - Any additional helpful information
3. Write the RMA number at the top of the packing list and on the shipping label and include a copy of your sales order.

Note: *Each RMA number is different. This number must appear on the shipping label and on all shipping documentation. All inquiries concerning the returned parts should also refer to this number.*

4. Ship your returned parts prepaid to:

**OMAX Corporation
Attn: Customer Service Department
21409 72nd Avenue South
Kent, WA 98032 USA**

Parts Ordered in Error

Returned parts ordered by a customer in error are subject to a testing and restocking charge of 15% of the list price. Parts returned for restocking must be returned prepaid to OMAX Corporation within 30 days of the original parts order ship date.

To return a part ordered in error for credit:

1. Obtain an RMA number. Return your ordered in error parts prepaid to OMAX Corporation within 30 days of the date the part was originally shipped.
2. Returned parts are examined by the Customer Service Department to ensure they are unused, in new condition, and free of handling damage.
3. If the parts are determined to be new and received within the 30-day limit, you receive full credit for the amount charged, minus the 15% restocking fee. A copy of the credit memorandum will be forwarded to you for use on future orders.
4. You must issue a new purchase order for any replacement parts.
5. Parts are shipped to you FOB Kent, Washington, USA.
6. If the returned parts are not new, or if OMAX receives them after the 30-day limit, the OMAX Customer Service Coordinator determines their proper disposition.

Unused Parts**To return unused parts for credit:**

1. Obtain an RMA number. Return your unused parts prepaid to OMAX Corporation within 30 days of the shipping date the part was originally shipped.
2. All parts are examined by the Customer Service Department to ensure they are unused, in new condition, and free of handling damage.
3. If the parts are determined to be new and are received within the 30-day limit, you receive full credit for the amount charged, minus the 15% restocking fee.
4. A copy of the credit memorandum will be forwarded to you for use on future orders.

Parts Shipped in Error

To return parts shipped in error for credit:

1. Obtain an RMA number. Return your shipped in error parts prepaid to OMAX Corporation within 30 days of the shipping date when the part was initially sent.
2. All parts are examined by the Customer Service Department to ensure they are unused, in new condition, and free of handling damage.
3. If the parts are determined new and are received within the 30-day limit, you receive full credit for the amount charged, and the part originally ordered is shipped.
4. If the returned parts are not new, or are received by OMAX after the 30-day limit, the OMAX Customer Service Coordinator determines the proper disposition.
5. If the replacement parts are needed sooner than 10 working days, issue a new purchase order and clearly label it with the RMA number and a tag that reads "Shipping Error."
6. If in stock, the replacement part will be shipped within three working days (same-day for urgent requests).
7. If the claim is approved, a credit memorandum for the originally shipped parts is forwarded to you. This credit can be used on future orders.

Parts Returned for Repair

To return parts for OMAX Repair Services:

1. Obtain an RMA number. Ship the parts along with a purchase order to OMAX Corporation.
2. Repair charges are based on standard rates for labor plus the currently listed price for any replacement components required.
3. You will be notified if the repair charge exceeds 50% of the cost for a new part.
4. The OMAX Repair Department completes the repair. If the parts are either not repairable, not cost effective to repair, or not approved for repair, they are either returned to you or scrapped upon your request.

Parts Returned for Warranty Repair or Replacement

To return parts for warranty repair or replacement:

1. The Customer Service Department evaluates all parts returned to ensure that they are covered by the OMAX Corporation warranty.
2. When a part is under warranty, OMAX determines if the part should be repaired or replaced.
3. When a part is not under warranty, it will either be repaired at your expense, returned to you without repair, or scrapped at your request.
4. When a part is urgently needed while the equipment is still under warranty, OMAX suggests that you issue a new purchase order for the required part.
5. Write the RMA number on the purchase order, and also note that the parts ordered are to replace parts sent in for warranty consideration.
6. If the part is in stock, it is shipped within three working days. If it is not in stock, the part will be sent as soon as possible.
7. If the warranty claim is approved, OMAX issues a credit memorandum for the parts.
8. A copy of the credit memorandum is sent to you for use on future orders.

Two Year Limited Warranty

OMAX Corporation ("OMAX") warrants its OMAX JetMachining® Center and all components of its manufacture (the "Products"), to be free of defects in workmanship and material for a period of two years from the date of shipment or 4,000 operational hours, whichever comes first. This warranty covers all machinery and electronics equally, however, it does not include wear parts and consumable parts such as seals, valves, abrasivejet nozzles, mixing tubes, orifices, high-pressure hose or high-pressure pump components. Further, Buyer is strongly cautioned that poor water quality and high inlet water temperature will significantly affect operational life of Products. This warranty specifically excludes coverage of any claims for the effects of corrosion, erosion, adverse water conditions and temperature, normal wear and tear, or component failures caused by (i) accident, (ii) negligence, misuse, improper installation or abuse, or (iii) unauthorized repair or alteration, or failure to maintain the OMAX JetMachining® Center that contains the affected components in accordance with the technical bulletins and specifications provided by the OMAX.

All labor is the responsibility and expense of the Buyer. The liability of OMAX under this warranty is limited, at OMAX's exclusive option, solely to repair or replacement with equivalent items or refund of the purchase price upon return of the subject nonconforming Product. Replacement parts may be either new or reconditioned, at OMAX's option. Freight charges, brokerage charges, duties and taxes for return of parts and for parts or components provided by OMAX under this warranty, will be the responsibility of the Buyer. This warranty is conditioned upon (a) OMAX being notified in writing by Buyer within 30 days after discovery of defects; (b) the return of presumed defective components to OMAX within 30 days of notification, transportation charges, brokerage charges, duties and taxes prepaid by Buyer, and (c) OMAX's examination of such components disclosing to its satisfaction that such defects were not caused by negligence, misuse, improper maintenance, abuse, improper installation, accident, or unauthorized repair or alteration.

Unauthorized repair or alteration shall specifically include any use of third party replacement parts which are not OMAX manufactured or supplied Products. Buyer is strongly cautioned that use of such unauthorized third party components will not be covered by any warranty whatsoever from OMAX and that further, OMAX may deny all other warranty coverage, if OMAX concludes, at its sole discretion, that failure of a Product claimed under this warranty had as a proximate cause the Buyer's use of other unauthorized replacement components which had the effect of causing the failure in the Product claimed under warranty.

Accessories or equipment manufactured by others but furnished by OMAX shall carry the warranty conveyed by the manufacturer to OMAX, which may be passed on to the Buyer. The original warranty period of any component that has been repaired or replaced by OMAX shall not thereby be extended.

OMAX will indemnify Buyer for any damages and costs finally awarded against Buyer on the grounds that a Product, (but not any items manufactured by third parties), infringe any valid United States patents or copyrights of any third party, provided that Buyer notifies OMAX in writing of any such claim within ten days after learning thereof and that Buyer gives OMAX full control over the defense and settlement of the claim, and fully cooperates with OMAX with respect thereto. If any such claim is brought or appears to OMAX likely to be brought, OMAX may at its option replace or modify the Products to make them non-infringing, or refund to Buyer, upon return of the Products at issue, the price paid therefor, less twenty percent for each year which has passed since the date of delivery hereunder. Buyer shall discontinue all use of any portion of the Products that has been replaced or modified or for which a refund has been tendered. OMAX's obligations hereunder shall not apply to any claim based on: i) OMAX having followed Buyer's specification or requests; ii) the use of Products to practice a process not recommended by OMAX, or iii) in conjunction with items or modifications not supplied by OMAX, and the Buyer shall similarly indemnify OMAX with respect to such claims. **THE FOREGOING STATES OMAX'S SOLE RESPONSIBILITY AND BUYER'S SOLE REMEDY FOR ANY INFRINGEMENTS OF PROPRIETARY RIGHTS.**

OMAX MAKES NO OTHER WARRANTY, EXPRESS OR IMPLIED, OF ANY KIND, INCLUDING ANY WARRANTY OF MERCHANTABILITY OR FITNESS FOR ANY PARTICULAR USE OR THOSE ARISING FROM COURSE OF PERFORMANCE, COURSE OF DEALING OR USAGE OF TRADE. IN NO EVENT SHALL OMAX BE LIABLE TO BUYER OR TO ANY THIRD PARTY FOR INDIRECT, SPECIAL, INCIDENTAL, CONSEQUENTIAL OR PUNITIVE DAMAGES INCLUDING WITHOUT LIMITATION, LOSS OF USE, DELAYS OR LOST PROFITS OR SAVINGS RELATED TO THE PRODUCTS, THE USE OR LOSS OF USE THEREOF, THE PERFORMANCE OR BREACH OF THIS AGREEMENT BY OMAX, OR OTHERWISE, EVEN IF OMAX IS AWARE OF THE POSSIBILITY OF SUCH DAMAGES, AND EVEN IF THE EXCLUSIVE REMEDIES STATED HEREIN FAIL OF THEIR ESSENTIAL PURPOSE. BUYER'S RIGHTS AS STATED HEREIN ARE ITS EXCLUSIVE REMEDIES.

Buyer agrees that regardless of the form or action, whether in contract or tort, including negligence, OMAX's liability for damages hereunder or otherwise with respect to the Products or their use shall not exceed the total sum paid by Buyer to OMAX for the Products causing such damages. (R/09/21/2010)

